

Primary 2

Choose the Right A
Ages 4-7

Primary 2

Choose the Right A

For teaching children ages four through seven

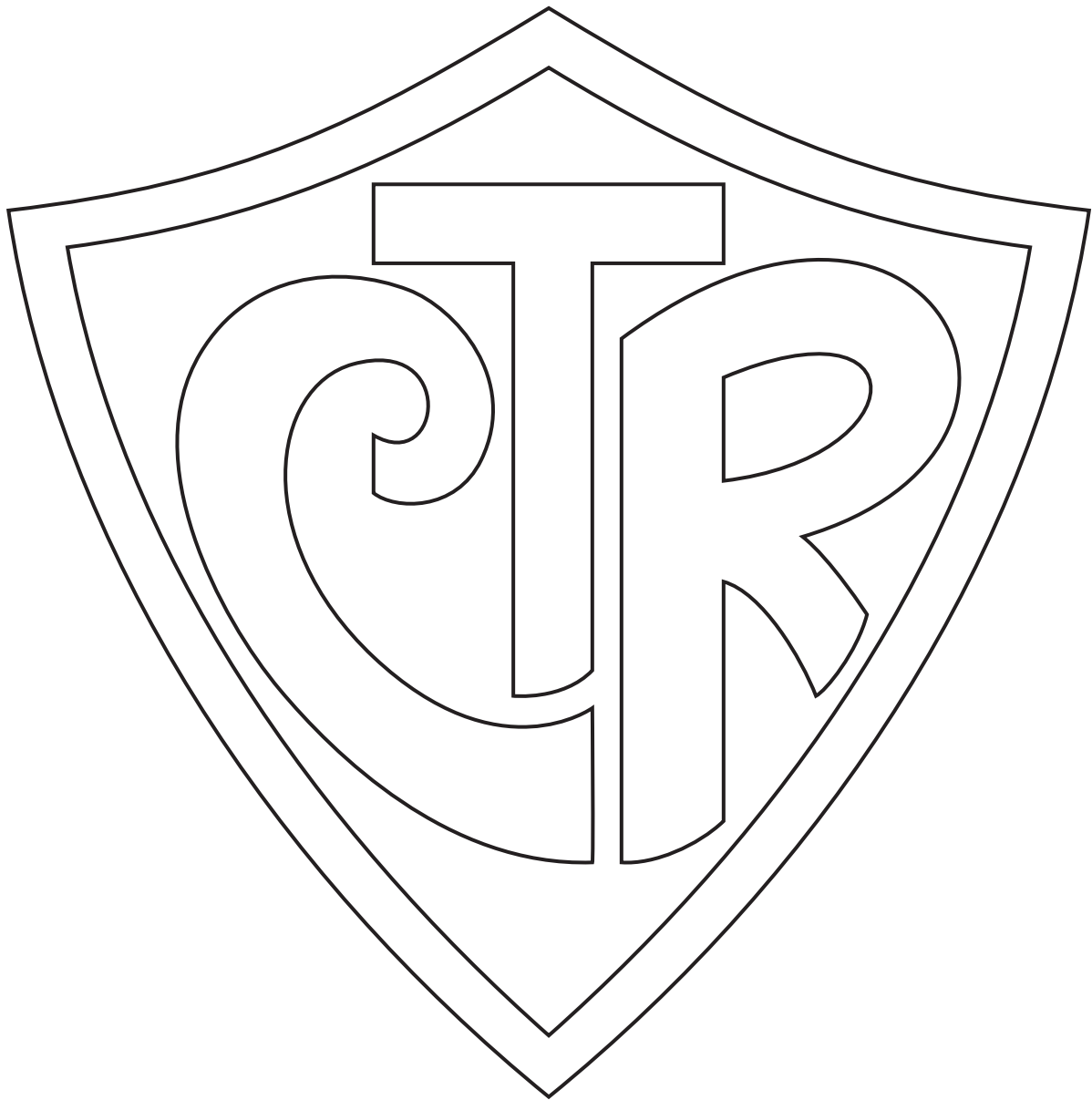

Contents

Lesson Number and Title	Page
Helps for the Teacher	vii
1 Happiness Comes from Choosing the Right	1
2 I Can Choose the Right	6
3 I Am a Child of God	11
4 I Chose to Follow Jesus Christ	16
5 I Can Make Right Choices	21
6 We Have Special Families	25
7 The Birth of Jesus Christ Brought Joy to the Earth	30
8 Heavenly Father Watches Over Me	35
9 Jesus Christ Was a Child like Me	39
10 I Can Speak with Heavenly Father in Prayer	44
11 I Can Tell Others about Jesus Christ	50
12 I Can Prepare for Baptism	55
13 The Gift of the Holy Ghost Can Help Me	61
14 Dare to Choose the Right	68
15 Come, Follow Me	75
16 Jesus Christ Has the Power to Heal	81
17 The Priesthood Helps Me	86
18 Prayers Are Answered in the Best Way	91
19 Jesus Christ Loves Me	96
20 The Teachings of Jesus Christ Are a Great Treasure	102
21 I Can Be Reverent	109
22 Blessed Are the Peacemakers	115
23 Jesus Christ Is the Good Shepherd	119
24 I Can Show Gratitude	124
25 Remember to Say "Thank You"	129
26 Choosing the Right Gives Me a Happy Feeling	134
27 I Can Help Others Be Happy by Sharing	139
28 I Can Be Kind	143

29	I Can Be a Good Example	149
30	I Can Be Obedient	155
31	I Will Obey the Law	162
32	Love One Another	168
33	I Can Pay Tithing	176
34	Always Tell the Truth	181
35	I Have Talents	187
36	I Am Wise When I Choose the Right	193
37	I Can Keep the Sabbath Day Holy	199
38	I Will Remember Jesus Christ during the Sacrament	206
39	I Can Follow Jesus Christ by Serving Others	212
40	I Can Forgive Others	217
41	Jesus Christ Is Our Savior	223
42	The Church of Jesus Christ Is on the Earth	229
43	Jesus Christ Will Come Again	235
44	I Can Show Love for Animals	240
45	We Celebrate the Resurrection of Jesus Christ (Easter)	247
46	Jesus Christ Is the Greatest Gift (Christmas)	253
	Words to the Songs	258

Helps for the Teacher

Purpose This manual has been written to help teach the children that by following Jesus Christ's example they can choose the right, be baptized, and become members of The Church of Jesus Christ of Latter-day Saints.

Message to Primary Teachers Our Father in Heaven has given you a sacred calling to teach children the gospel of Jesus Christ and help them learn to live it. As you serve the children and invite each one to "come unto Christ," you will bless their lives. You can help them begin to understand Heavenly Father's blessings and receive testimonies of his gospel. You will also grow personally and learn from the children. Your service in Primary can bring you great joy. By serving Primary children, you are also serving Heavenly Father (see Mosiah 2:17).

As you live the principles of the gospel, study the scriptures, follow the counsel of priesthood leaders, and draw near to Heavenly Father through prayer, you will receive inspiration from the Holy Ghost regarding the children you teach. Bear your testimony often to the children, and let the Holy Ghost work through you in this important calling. As you do so, the Spirit will direct you so that what you do in Primary will be acceptable to our Heavenly Father.

Class Information *CTR* stands for *Choose the Right*. The CTR shield, found in the front of this manual, and the CTR ring (31362) are used in several lessons. In addition, lesson 1 contains instructions for making a CTR chart, which will also be used in several lessons. The CTR ring serves as a personal reminder to its owner to choose the right. If the CTR ring is available in your area, counsel with the bishop or branch president about the availability of ward or branch funds to purchase a ring for each child.

Class Time

Prayer Open and close every class period with prayer. Give each child regular opportunities to say the prayer. Make prayer a meaningful part of the class by giving instructions and suggestions for prayers and by asking the children for ideas to include in the prayer. Focus your suggestions on class needs and the lesson's message.

Teaching the lessons Prepare each lesson carefully and prayerfully so the children will understand and enjoy it and so you will have the guidance of the Spirit.

Teach the lessons in order, except for lessons 45 and 46 (Easter and Christmas). If any of the children in your class will be baptized during the year, you may want to teach lessons 12 and 13, which are on baptism and confirmation, before the first child in your class is baptized.

Select from the lesson materials those that are appropriate for your class. Enrichment activities listed at the end of each lesson are meant to be used during the lesson as you see fit. Not all lesson materials or enrichment activities will be appropriate for the children in your class or area. Some activities may be too difficult for four-year-olds; others may be too simplistic for seven-year-olds to enjoy.

Select activities that your class will respond to well. If you have younger children in your class, you may want to use songs and finger plays often during the lesson to help keep their attention. You can repeat a song or finger play several times if the children enjoy it. In place of wordstrips for younger children, you can illustrate the concept being taught by using pictures you have drawn or cut out of magazines.

Do not read the lesson to the children. They will respond better if you present it in your own words. Bear a brief, personal testimony often so that class members will be more likely to hear and respond to the gospel message with the Spirit.

The manual *Teaching—No Greater Call* (33043) can help you in teaching the lessons.

Music in the classroom

Music can bring the Spirit of the Lord into the classroom. Singing as a class can make your lessons more interesting and can help the children better remember the lesson concepts.

The words to songs that are used more than once in this manual are printed at the back of the manual. The words to songs used only once in the manual are included within the lessons. Music for these songs can be found in the *Children's Songbook* (35395). Recorded music from the *Children's Songbook* is available on audiocassettes (music only, 52505; words and music, 52428) and compact discs (music only, 50505; words and music, 50428).

You need not be a skilled musician to make classroom singing a rewarding experience. The children will not know whether or not you sing well; they will know only that you enjoy singing. Learn and practice the songs at home as part of your lesson preparation. If you need special help, ask the Primary music leader or pianist for assistance. (For additional help, see "Music in the Classroom," *The How Book for Teaching Children* [31109], pp. 40–42.)

You may want to use appropriate actions with the songs, particularly if you have younger children in your class. You may also say the words rather than sing them.

Articles of Faith

The Articles of Faith are an important part of the Primary curriculum. When an article of faith is used in a lesson, encourage the children to memorize as much of the article of faith as they can.

Scriptures

Bring your scriptures to class each week and let the children see you reading and teaching from them. If the children have their own copies of the scriptures, encourage them to bring them to class each week. Help older children find and read passages used in the lesson. Occasionally bear your testimony of the value of the scriptures.

Teaching aids

Pictures. Most of the pictures used in the lessons are numbered and included in a packet that comes with the manual. These pictures should stay with the manual. The pictures needed for each lesson are listed in the "Preparation" section of the lesson. Also included in the "Preparation" section is a meeting-

house library item number for pictures that may be available in larger sizes in your meetinghouse library (some library pictures may be different pictures of the same subject) and a Gospel Art Picture Kit number for pictures included in that kit.

Visual aid cutouts. The cutouts used in the lessons are included with the manual and should be kept with the manual. Cut out and use the figures in the appropriate lessons. You will need to make other simple teaching aids suggested in the lessons, such as wordstrips, charts, and handouts. Save these aids to use later with other lessons and in upcoming years.

Music. See “Music in the Classroom,” p. viii.

Food. Whenever a lesson suggests using food, please check with the parents of the children in advance to ensure that none of the children has allergies or other adverse physical reactions to the food. Please do not bring food on fast Sunday.

Sharing Time Presentations

Occasionally your class will be asked to give a simple gospel presentation during Primary sharing time. Such presentations should be adapted from the lessons. Look for suitable ideas for sharing time as you prepare and present the lessons. You may also choose to share a principle from the current children’s sacrament meeting presentation.

Having children teach a gospel principle under your direction during sharing time is an effective way to help them learn and share that principle.

Make sure the sharing time presentation is simple and does not require much rehearsal. You may use part of a class period to prepare the presentation. The following suggestions may be used for effective, simple class presentations:

1. Help the children act out a story or situation from a lesson.
2. Have the children tell a story from a lesson using pictures, wordstrips, or cutout figures.
3. Have the children explain their feelings about their coming baptisms. If any children have reached the age of eight and have been baptized, ask them to share their feelings about baptism.
4. Help the children repeat and explain an article of faith. You may also wish to have them sing one of the article of faith songs from the *Children’s Songbook*, pp. 122–33.

For additional help, see the *Primary Sharing Time Resource Manual* (33231).

Sharing with the Children’s Families

Encourage the children to share what they learn in Primary with their families. Invite parents to visit and participate in your class occasionally to enrich the lessons. Be open to ideas from parents that will help make Primary more meaningful for their children.

Preparing for Baptism

If you have seven-year-olds in your class, some of them will probably be baptized during the year. As a Primary teacher, you can support the children's families and help class members prepare for baptism. Consider the following suggestions to help you do this:

1. If possible, teach the lessons on baptism and confirmation (lessons 12 and 13) before the first child in your class is baptized.
2. Take a few minutes of class time on the Sunday before each child's baptism to discuss the importance of this ordinance.
3. If possible, attend each child's baptism with a member of the Primary presidency and any class members who can attend.
4. Help the children prepare class presentations about baptism for sharing time.

Understanding the Children

Your calling to teach children the gospel of Jesus Christ is a sacred trust given to you through your bishopric or branch presidency. These priesthood leaders have called you by inspiration from Heavenly Father. You can greatly influence the children in your class to follow the Savior throughout their lives.

Always show a positive attitude and love for the children in the class. Become acquainted with each child's talents, interests, and abilities. Adapt lesson activities requiring reading and writing to the abilities of the children.

Help all the children build a positive sense of self-worth by listening to them and giving each of them as much individual attention as possible.

These lessons have been written for classes of either same-age or mixed-age groups of children from four to seven years old. However, you may need to adapt the lessons according to the ages of the children in your particular class. Regardless of how your class is organized, understanding the general age characteristics of the children will help you teach more effectively. This can help you know why the children behave as they do and how to teach them in ways that they can best learn. Understanding the children will also help you maintain a positive feeling in the classroom. Review the following characteristics as you prepare your lessons. Remember, however, that each child matures at his or her own rate. These are only general guidelines.

Four-year-olds

Four is the age of finding out. *Why* and *how* are two of the words most frequently used by four-year-olds. Four-year-olds are very active. The following are general characteristics of four-year-olds:

1. They can run, jump, and climb with more ease and confidence than three-year-olds. They can throw or kick a ball and build a house out of blocks.
2. They are fond of saying such things as "I did that before; I can make something different now."
3. They like to play with other children but are not socially ready for a large group.
4. Although they want and need other children to play with, they play mostly as individuals. They may play or dance to music with a group, but they do not pay much attention to how other children are playing or dancing.

5. In addition to asking many questions, they can carry on a conversation with another child or with an adult.
6. Since their experience has been mainly in the home, they talk mostly about home and family. Children this age love to tell the teacher about their families. They would often rather tell their own stories than listen to the stories of other children. They love lessons and activities that focus on the family.
7. They live completely in the here and now. Yesterday and tomorrow mean little. They do, however, show great excitement for coming events, and because they cannot yet grasp the meaning of time, they may ask of some future event, "Is it tomorrow?"
8. They like to listen to stories and nursery rhymes. They want to hear favorite stories over and over again without the slightest change. After hearing the story, they like to dramatize the characters.
9. They can learn to pray with a little help.

Five-year-olds

Five-year-olds tend to be more sure of themselves and are generally dependable. They usually have learned to do what is expected of them in the household. They play well with other children, but they can also amuse themselves alone in a number of ways, such as skipping about or drawing pictures. The following are typical behavior patterns for five-year-olds:

1. Their large-muscle coordination continues to improve. They can now skip, turn somersaults, and hop on one foot. They can pull a sled or wagon with some ease.
2. Their small-muscle coordination now permits them to paste, cut out pictures, and color predrawn pictures, even though they might not stay within the lines. Many can also tie their shoes.
3. They are more reliable and independent than four-year-olds. They often like to help around the house and are happy when they can work along with their parents.
4. They are serious when they ask, "What is that for?" or "How does this work?" They want and should receive thoughtful, honest answers, in language and detail that they can understand.
5. They love their teachers and think it is a privilege to sit by them. They are delighted when teachers ask them to help with the lesson by holding a picture or doing something else to help.
6. They like small-group projects and dramatizations about home and family.
7. They love to hear and tell stories, and they ask for the same story over and over again. Repetition is their main way of learning. Often they can tell a story almost word for word as they turn the pages of a book.
8. They are usually friendly, sympathetic, affectionate, and helpful, but when they don't get their own way, they can be very quarrelsome.
9. They like to receive new privileges to show that they are bigger and older.
10. With an attention span from ten to twelve minutes, they change rapidly from one activity to another. They are beginning to think that they are too old for finger plays, and they want more grown-up activities or rest exercises.

11. They will often demand to play with something that another child is already playing with. Try to handle such matters carefully; teach the children to take turns.
12. They prefer small groups to large ones. They would rather play with one best friend than be with a group of ten.
13. They have not yet learned to distinguish between imagination and reality. Therefore, a child may say that his clock is made of gold, that his father is bigger than any other father, or that the fish he caught was extremely long. This is a normal phase in a child's life; it takes time for children to learn to distinguish between what is real and what is not. This phase passes as children develop.
14. They are eager learners. Since Heavenly Father is very real to them, they are very interested in him and ask many questions about him. They enjoy praying and may be able to pray without help.

Six-year-olds

Six-year-olds have acquired good control over their bodies and have a great deal of energy to expend on learning new skills and perfecting those already gained. For example, they may learn to jump rope, bounce a ball, whistle, turn handsprings, and ride a bike. Six-year-olds may still have some difficulty using their small muscles, but they can learn to print the letters of the alphabet, their own names, and a few other words. The following are other general characteristics of six-year-olds:

1. Their attention span is increasing. Even though they can become very restless, they can also concentrate on an activity for fifteen or twenty minutes, depending on their interest.
2. They enjoy whole body movements, such as climbing trees, performing on playground equipment, or running races.
3. They like games and friendly competition.
4. The teacher's opinion is very important to them. They want to sit by the teacher and help with the lesson by holding pictures or carrying materials back to the library.
5. They still like to hear stories, dramatize them, and pretend. Many like to dress in grown-up clothes.
6. They are very generous, affectionate, and compatible until they don't get their own way, and then they can be very quarrelsome.
7. They may have perfected skipping, galloping, and hopping. They enjoy using these skills in games.
8. They are very concerned with what is good and bad behavior.
9. Their faith in Heavenly Father and Jesus Christ is increasing. Most six-year-old children can pray alone if they have had previous experience at home or in other classes.

Seven-year-olds

At seven, children are still close to their parents and still appreciate their love, attention, and sympathy, but they are beginning to relate more to people and situations outside the home. They have individual tastes and want to be allowed to make some of their own decisions. They are lively, eager, and tremendously

interested in life about them. They explore many activities and like to repeat those that give them pleasure. The following are other general characteristics of seven-year-olds:

1. Their large muscles are well controlled, and they are becoming more graceful, speedy, and agile.
2. Their small-muscle control is developing. They are able to print more easily and more accurately.
3. Many like rough-and-tumble games, playing the same ones over and over.
4. They are often restless and fidgety. They are full of energy but tire easily. Rest periods are important.
5. They like to collect things and talk about them. They also like to talk about things they have made either by themselves or in groups.
6. Their attention spans are growing; children this age can complete a project if it interests them, even though it takes from twenty to twenty-five minutes. They still need to have a change in activity in most lessons.
7. They are beginning to interact less with members of the opposite sex.
8. They are becoming less domineering and less determined to have their own way.
9. They are becoming more independent and more logical in their thinking.
10. They are more aware of right and wrong and are very critical of those who do not do what they think is right.
11. They are looking forward to baptism.
12. They can pray alone and often expect an immediate answer to their prayers.
13. They may take pride in the fact that they can fast at least one meal on fast Sunday and that they pay tithing.

**Special
Guidelines
for Including
Those with
Disabilities**

The Savior set the example for us in feeling and showing compassion for those with disabilities. When he visited the Nephites after his resurrection, he said:

“Have ye any that are sick among you? Bring them hither. Have ye any that are lame, or blind, or halt, or maimed, or leprous, or that are withered, or that are deaf, or that are afflicted in any manner? Bring them hither and I will heal them, for I have compassion upon you” (3 Nephi 17:7).

As a Primary teacher you are in an excellent position to show compassion. Though you may not be trained to give professional assistance, you can understand and nurture children who have disabilities. Concern, understanding, and a desire to include each class member in the learning activities are needed.

Children with disabilities can be touched by the Spirit no matter what their level of understanding. Although some children may not be able to attend the entire Primary time, they need to have the opportunity to attend even briefly to feel

the Spirit. It may be necessary to have a companion who is sensitive to a child's needs be with the child during Primary in case the child needs time away from the whole group.

Some class members may be challenged by learning disabilities, intellectual impairments, language or speech problems, vision or hearing loss, behavioral and social problems, mental illness, movement and mobility problems, or chronic health impairments. Some may find the language or cultural setting unfamiliar and difficult. Regardless of individual circumstances, each child shares the same needs to be loved and accepted, to learn the gospel, to feel the Spirit, to participate successfully, and to serve others.

These guidelines can help you teach a child with disabilities:

- Look beyond the disability and get to know the child. Be natural, friendly, and warm.
- Learn about the child's specific strengths and challenges.
- Make every effort to teach and remind class members of their responsibility to respect every class member. Helping a class member with a disability can be a Christlike learning experience for the entire class.
- Find the best methods for teaching the child by consulting with parents, with other family members, and, when appropriate, with the child.
- Before calling on children with disabilities to read, pray, or otherwise participate, ask them how they feel about participating in class. Emphasize each child's abilities and talents and look for ways each child can participate comfortably and successfully.
- Adapt lesson materials and physical surroundings to meet the individual needs of children with disabilities.

Additional materials for teaching children with disabilities are available from Church distribution centers (see "Materials for Those with Disabilities" in the distribution center catalog).

Dealing with Problems of Abuse

As a teacher you may become aware of children in your class who suffer from emotional or physical abuse. If you become concerned about a child in your class, please counsel with your bishop. As you prepare and present lessons, pray for the Lord's guidance and direction. Help each child in your class feel that he or she is a precious child of Heavenly Father and that Heavenly Father and Jesus Christ love each of us and want us to be happy and safe.

Happiness Comes from Choosing the Right

Lesson

1

Purpose To help each child understand that happiness comes from choosing the right.

- Preparation**
1. Prayerfully study Matthew 5:6 and 3 Nephi 12:6. See also Doctrine and Covenants 58:27 and *Gospel Principles* (31110), chapter 4.
 2. Make a CTR chart. Attach picture 2-1, Jesus with a Child, to a larger piece of paper or posterboard. Print the letters *CTR* above the picture and the words *I will choose the right* underneath the picture. Save this chart for use in future lessons.
 3. Talk with each child's parents to learn a few details about each child to share with the class.
 4. Prepare to sing or say the words to "Choose the Right Way" (*Children's Songbook*, p. 160). The words to this song are included at the back of the manual.
 5. Materials needed:
 - a. A Bible or a Book of Mormon.
 - b. Chalk, chalkboard, and eraser.
 - c. A CTR ring for every child who does not already have one (see "Class Information" in "Helps for the Teacher," p. vii).
 - d. A copy or tracing of the CTR shield (found at the front of the manual) for each child.
 - e. Crayons and scissors.
 - f. A long piece of yarn for each child.
 6. Make the necessary preparations for any enrichment activities you want to use.
-

Suggested Lesson Development

Give the opening prayer, expressing your love for Heavenly Father, Jesus Christ, and the children in the class.

Heavenly Father and Jesus Christ Love Us

Attention activity Tell the children a little about yourself and about your feelings and desires for this year's Primary class. Introduce each child to the other class members, telling something about the child as you do so.

CTR chart Display the CTR chart you have made. Tell the children that this year in Primary they will be learning about Jesus Christ, our Savior. One of the most important things they will learn is how much Jesus loves each one of them. Testify that Jesus loves each of the children in your class. Mention each child by name, as in this example: "Jesus loves Stephanie." Tell the children that Heavenly Father also loves each of them.

Heavenly Father and Jesus Christ Want Us to Be Happy

Teacher presentation

Tell the children that because Jesus Christ and Heavenly Father love each of us so much, they want us to be happy. Share with the children some times when you have felt really happy. (Examples could include getting baptized, sharing with others, doing something fun with your friends, working to achieve a goal, spending enjoyable moments with your family, reading and learning about Jesus, getting married in the temple, or serving a mission.)

Child participation

Let the children talk about times when they are happy. If the children need some prompting, ask questions such as the following:

- Are you happy when you play with your brothers and sisters?
- Are you happy when you help your mother or father?
- Are you happy when you get to do a favorite activity?
- Are you happy when you come to church?

Choosing the Right Brings Happiness

Story and discussion

Tell the following story in your own words:

James was a boy who was just the right age to be a member of our class. One day he asked his Primary teacher if he could bring his pet to class. His teacher replied, "Choose the right, James. Choose the right."

- What do you think James chose to do?

When he asked his Primary teacher if he should bring a friend to church, she said, "Choose the right, James. Always choose the right."

- What choice do you think he made?

James had heard his parents say these same words many times: "Choose the right, James. Heavenly Father and Jesus want us always to choose the right."

- What does it mean to choose the right?

One day when James came home from school, he found his mother had left a cookie for him and one for his brother. James loved cookies, and he ate his quickly. Then he looked at his brother's cookie. His brother was not home, and no one was around to say, "Choose the right, James. Always choose the right."

- What would you do?
- What would James do if he chose the right?

James ate his brother's cookie. When James's brother came home, he saw that there was no cookie for him. He thought his mother had forgotten to leave him a cookie, and he was very sad. James felt bad because he had eaten his brother's cookie.

- Did James choose the right?
- Was James happy about his choice?
- What should James do now?

Help the children think of ways that James could correct his wrong choice. Emphasize that we should always try to choose the right, but if we do choose

wrong, we should try to correct our wrong choices. When we make wrong choices we will be unhappy, but when we make right choices we will be happy.

Scripture

Tell the children that Jesus has told us that we will be happy when we choose the right. Read aloud Matthew 5:6 or 3 Nephi 12:6 (through *righteousness*). Explain that to “hunger and thirst after righteousness” means to choose the right. We will be blessed when we choose the right.

CTR Stands for Choose the Right

Chalkboard activity

- How could your mother mark something that belongs to you without writing your whole name? (She could use your initials.)

Explain that our initials are the beginning letters of our names.

Tell the children what your initials are. Print them on the chalkboard and repeat your name, pointing to each initial at the appropriate time.

- What are your initials?

Put the children’s initials on the chalkboard and show how they represent their names. Print the initials first and then add the remainder of the names. (If you have a large class, use just a few children’s initials as examples.)

Print *CTR* vertically on the chalkboard, as shown below. Have the children raise their hands if they can read the letters.

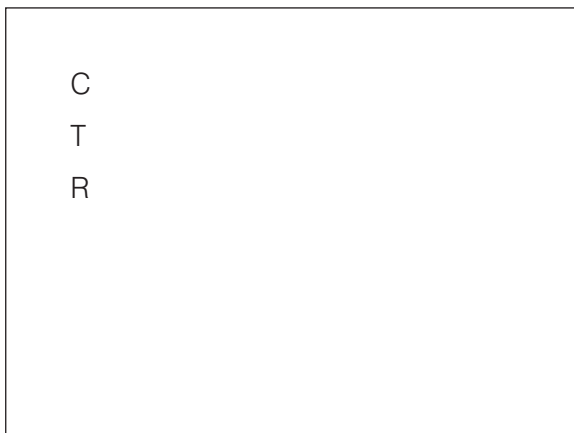

Read the initials aloud with the entire class. Tell the children that these initials stand for three important words. Complete the words on the chalkboard:

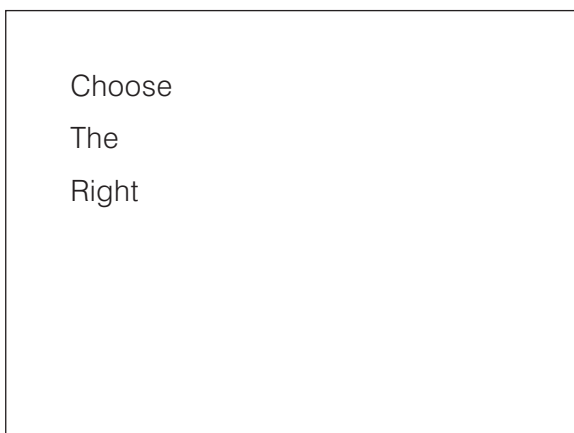

Read the words with the children and have them repeat the initials. Then say together what the initials stand for.

Emphasize to the children that when they say “CTR,” they should think of “choose the right.” Tell them that these initials will help them remember to follow Jesus Christ and do the things that will make them happy.

We Can Remember to Choose the Right

CTR chart	Refer to the picture of Jesus Christ on the CTR chart. Tell the children that this year in Primary they will learn about many of the things Jesus did and taught while he was on the earth. Explain that Jesus always chose the right, and he wants us to choose the right so we will be happy and so we can help make others happy. Have the children stand and say together the words on the CTR chart: “I will choose the right.”
Song	Help the children sing or say the words to “Choose the Right Way.” Repeat the song a few times until the children are able to sing or say some of the words on their own.
CTR ring	Pass out the CTR rings to those children who do not already have one (if CTR rings are unavailable, skip to the CTR shield activity and discuss the letters on the shield). Have all the children look at their rings. <ul style="list-style-type: none">• What do the initials on this ring stand for? (Choose the right.) Tell the children that their CTR rings can help them remember that Jesus wants them to choose the right.
CTR shield activity	Give each child crayons and a copy of the CTR shield to color. Help each child cut out the shield and make a small hole in the top to thread a piece of yarn through. Tie a knot in the yarn so the child can wear the shield around his or her neck.

Summary

Review discussion	<ul style="list-style-type: none">• What does <i>CTR</i> mean?• What does it mean to choose the right?• Who loves each of us and wants us to be happy? (Heavenly Father; Jesus Christ.)• What do Heavenly Father and Jesus want us to do so we can be happy?
Testimony	Bear your testimony that Heavenly Father and Jesus Christ love us and want us to be happy. Tell the children that we can find peace and happiness by following Heavenly Father and Jesus and choosing the right. Compliment the children for choosing the right by coming to Primary, and encourage them to attend each week. Encourage the children to memorize the words on the CTR chart (“I will choose the right”) during the coming week. Invite a child to give the closing prayer.

**Enrichment
Activities**

Choose from the following activities those that will work best for the children in your class. You can use them in the lesson itself or as a review or summary. For additional guidance, see “Class Time” in “Helps for the Teacher.”

1. Explain to the children that in Primary this year they will be learning many things about choosing the right.

Display picture 2-4, The Pre-earth Life; picture 2-24, Calling of the Fishermen; and picture 2-39, The Prophet Joseph Smith. Tell the children that they will learn about some important people who chose the right. Give a brief preview of each picture.

- Picture 2-4. We chose the right by choosing to come to earth (see lesson 4).
 - Picture 2-24. Jesus’ Apostles chose the right by leaving their fishing to follow him (see lesson 15).
 - Picture 2-39. Joseph Smith chose the right by praying to find the true church (see lesson 20).
2. To help the children get to know each other better, write each child’s name on a piece of paper and put the papers in a container. Let each child choose a name from the container and give clues about the person whose name was drawn until the rest of the class guesses who it is. Clues could include statements such as “This person smiles a lot,” “This person is wearing blue,” or “This person has black hair.”
 3. Describe some actions that the children might take. Ask the children to stand up if the action represents a right choice and to sit down if the action represents a wrong choice. Use the following examples or create some of your own:
 - Get up early so you will be ready for church on time.
 - Complain loudly when you don’t get what you want for breakfast.
 - Help your little sister find her lost shoe.
 - Say “hello” to the new child in your Primary class.
 - Stamp your feet noisily as you enter the meetinghouse.
 - Think about Jesus Christ during the sacrament.
 - Listen quietly to the lesson in your Primary class.

Lesson
2

I Can Choose the Right

Purpose To help each child understand that he or she can choose the right by asking, “What would Jesus want me to do?”

Preparation

1. Prayerfully study 2 Nephi 31:10.
2. Make a nest with eggs in it to illustrate the story in the lesson. Fill a bowl with straw, grass, or yarn. Put three hard-boiled eggs in the nest. If eggs are not available, cut three egg-shaped pieces of paper to put in the nest.
3. Number five pieces of paper from one to five and put them in a small sack or other container.
4. Prepare to sing or say the words to “I’m Trying to Be like Jesus” (*Children’s Songbook*, p. 78). The words to this song are included at the back of the manual.
5. Materials needed:
 - a. A Book of Mormon.
 - b. CTR chart (see lesson 1).
6. Make the necessary preparations for any enrichment activities you want to use.

Suggested Lesson Development

Invite a child to give the opening prayer.

Follow up with the children if you encouraged them to do something during the week. You may want to ask the children if they were able to memorize the words from the CTR chart (“I will choose the right”).

Jesus Christ Wants Us to Choose the Right

Attention activity Have the children play “Follow the Leader.” The children stand in a line. The child first in line runs, hops, skips, or does some other action to the other side of the room. The other children follow, doing what the first child did. Then the first child goes to the end of the line, and the second child becomes the leader. Repeat until each child has had a turn to be the leader.

Scripture discussion Read aloud the first part of 2 Nephi 31:10, through *Follow thou me*. Explain that Jesus Christ said these words. Jesus wants us to follow him.

- How can we follow Jesus?

Read aloud the rest of 2 Nephi 31:10. Explain that we follow Jesus Christ when we obey the commandments and do the things he would do.

CTR chart Display the CTR chart. Tell the children that as they learn more about Jesus they will be able to make better choices, because Jesus’ teachings tell us what is right.

Story and discussion

Explain that when we have a difficult choice to make, we can ask ourselves a question that might help us know what is right. The question is, "What would Jesus want me to do?"

Tell the following story in your own words, using the nest you made as an illustration:

A young boy named Warren lived near a bird refuge. A refuge is a place where birds are protected. Warren's father's job was to help protect the birds. Warren had found a nest in the tall grass near his home, and he loved to look at the eggs in the nest when the mother bird was away. One day when Warren was looking at the eggs, he heard a loud noise. He looked up and saw that two boys from his school had shot a bird with a slingshot.

The two boys saw Warren and came up to look at the nest. One of the boys wanted to smash the eggs. Warren convinced the boys not to smash the eggs, and he told them that it was against the law to kill birds in the refuge. The boys told Warren that he had better not tell anyone that they had shot a bird. They did not want to be punished for breaking the law. As Warren went home, he walked very slowly, thinking about what he should do. If he told his father about the boys, they might make fun of him or hurt him.

Point to the picture of Jesus on the CTR chart.

- What question should Warren ask himself to help him choose the right? ("What would Jesus want me to do?")
- What would you do?

Warren decided to tell his father about the boys. His father said he would talk to the boys and their parents. When Warren told his father that he was worried about seeing the boys at school, Warren's father suggested Warren find a way to make the boys his friends.

Warren didn't want to be friends with boys who would shoot birds and smash their eggs. He was upset that his father had made that suggestion. All that night Warren thought about what his father had said. Warren had another decision to make.

- What decision did Warren have to make?

Point to the picture of Jesus on the CTR chart again.

- What question should Warren ask himself? ("What would Jesus want me to do?")
- What should Warren do?

When Warren saw the boys again, they were angry with him for telling his father about them. They threatened to beat him up. Warren was afraid, but he decided to do what Jesus would want him to do. He told the boys that he and his father were going to take a hike on Saturday, and he asked if they would like to come along. The boys were surprised and didn't say anything for a while. They had not expected Warren to be friendly to them. Finally they agreed to go. As Warren said good-bye to the boys, he had a peaceful feeling. He knew that making the boys his friends was the right thing to do. (Adapted from Claudia Remington, "The Nest," *Friend*, May 1980, pp. 2-5.)

- Why did Warren have a peaceful feeling?
- When have you had a peaceful feeling because you chose the right and did what Jesus wanted you to do?

Invite the children to talk about any experiences they have had with choosing the right.

We Can Do What Jesus Christ Wants Us to Do

Discussion activity

Have the children repeat the question “What would Jesus want me do?” Tell them that they are going to practice answering this question. Show the sack or container with the numbered pieces of paper in it. Let the children take turns choosing a piece of paper. Read the situation that corresponds with the number each child has chosen, and have the child answer the questions. (If you have a large class, you may want to add more situations.)

1. You are building with your blocks. Your baby sister knocks over what you have made.
 - What question should you ask yourself?
 - What would Jesus want you to do?
2. Your friend has come over to your house to play. Your brother wants to play with you and your friend, but you would rather play with your friend alone.
 - What question should you ask yourself?
 - What would Jesus want you to do? (Point out that inviting your brother to play is not the only answer; help the children come up with other kind solutions.)
3. You want to play ball with the children next door. They call you names and tell you to go home. You feel like calling them names too.
 - What question should you ask yourself?
 - What would Jesus want you to do?
4. Your mother asks you to make your bed before you go out to play. Your friends are waiting for you at the front door.
 - What question should you ask yourself?
 - What would Jesus want you to do?
5. Your father needs help cleaning up the yard around your house. You would rather go inside and finish the book you have been reading.
 - What question should you ask yourself?
 - What would Jesus want you to do?

Explain that the teachings of Jesus do not tell us exactly what to do in every situation. Jesus wants us to learn to make wise choices. He wants us to learn how to think and to show love and kindness.

Summary

Song

With the children, sing or say the words to “I’m Trying to Be like Jesus.”

Testimony

Remind the children that we can be like Jesus Christ by choosing the right. Testify that Jesus loves them and wants them to choose the right so they will have happy, peaceful feelings.

Encourage the children to ask themselves, “What would Jesus want me to do?” when they have to make a decision this week.

Invite a child to give the closing prayer. Ask the child to pray that the class members will remember to ask themselves what Jesus wants them to do.

Enrichment Activities

Choose from the following activities those that will work best for the children in your class. You can use them in the lesson itself or as a review or summary. For additional guidance, see “Class Time” in “Helps for the Teacher.”

1. Give the children paper and crayons and let them draw pictures of things Jesus would want them to do, such as coming to church, helping their parents, comforting a lonely child, or playing with their brothers and sisters. Write on each child’s paper *What would Jesus want me to do?*
2. Sing or say the words to “Dare to Do Right” (*Children’s Songbook*, p. 158) or “Nephi’s Courage” (*Children’s Songbook*, p. 120). The words to “Dare to Do Right” are included at the back of the manual. After you sing, remind the children of the story about Warren. Warren had to make some hard choices.

- Why is it sometimes hard to choose the right?

Tell the children that even though it is sometimes hard, if we always try to choose the right we will have peaceful, happy feelings.

Nephi’s Courage

The Lord commanded Nephi to go and get the plates
From the wicked Laban inside the city gates.

Laman and Lemuel were both afraid to try.

Nephi was courageous. This was his reply:

“I will go; I will do the thing the Lord commands.

I know the Lord provides a way; he wants me to obey.

I will go; I will do the thing the Lord commands.

I know the Lord provides a way; he wants me to obey.”

(© 1986 by Wilford N. Hansen Jr. and Lisa Tensmeyer Hansen. Used by permission.)

3. Make a copy of the handout at the end of the lesson for each child. Cut out the small wordstrips on the bottom of the handout (leave off the numbers). Give each child a copy of the song and a set of wordstrips. Read the wordstrips and the song on the handout and help the children decide where the wordstrips fit into the song. Give the children a small amount of glue or tape to attach the wordstrips to their copies of the song. Print or have the children print their names on their handouts.

When the children have finished attaching their wordstrips, help them sing “Choose the Right Way” once or twice. Compliment them on doing a good job.

Choose the Right Way

There's a _____ (1) _____ way to live and be happy;

It is _____ (2) _____ every day.

I am learning the teachings of _____ (3) _____ ;

They will help me and show me the way.

_____ (4) _____ way and be happy.

I must always _____ (5) _____ .

(1)

(2)

(3)

(4)

(5)

I Am a Child of God

Lesson

3

Purpose

To help each child realize that Heavenly Father loves each of us because we are his children.

Preparation

1. Prayerfully study Psalm 82:6. See also Hebrews 12:9; Moses 1:39; and *Gospel Principles* (31110), chapter 2.
2. Make a paper doll chain by folding a piece of paper accordion-style (see illustration below). Sketch half a figure of a person on the folded edge of the paper. Cut around the figure but do not cut into the folded edge where the body is or around the hand. The dolls will unfold with their hands joined together. You may want to cut out the dolls in class, while the children watch, or make a small paper doll chain for each child.

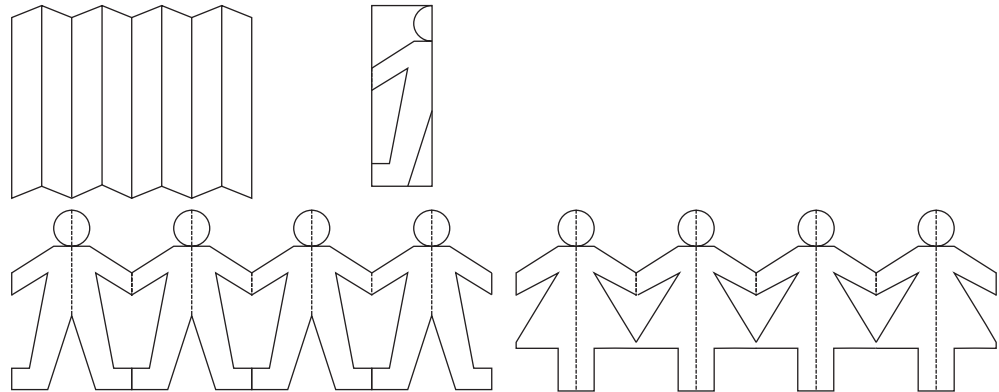

3. Prepare three wordstrips:

Spirit

Physical Body

Family

4. Prepare to sing or say the words to “My Heavenly Father Loves Me” (*Children’s Songbook*, p. 228) and “I Am a Child of God” (*Children’s Songbook*, p. 2). The words to “I Am a Child of God” are included at the back of the manual.
5. Materials needed:
 - a. A Bible.
 - b. A small mirror.
 - c. A five-fingered glove (if a glove is not available, you might want to bring a picture or drawing of a glove).
 - d. Picture 2-2, Family with a Baby (62307), or a photograph of a newborn baby.
6. Make the necessary preparations for any enrichment activities you want to use.

**Suggested
Lesson
Development**

Invite a child to give the opening prayer.

Follow up with the children if you encouraged them to do something during the week. You may want to have them report on their experiences as they have asked, "What would Jesus want me to do?"

Who Am I?

Attention activity

Ask the question:

- Who am I?

After the children have answered, repeat your full name.

Point to each child and ask, "Who are you?" Have each child answer by stating his or her name. Explain that each of us is a unique person.

Discussion

Show picture 2-2, Family with a Baby, and let the children point out the members of the family, or show the picture of a newborn baby.

- How old do you think this baby is?
- Where did this baby live before it was born on earth?

Explain that we all lived in heaven with Heavenly Father before we came to this earth. We are his children. That is why we call him Heavenly Father. We also lived with our heavenly mother and all the rest of Heavenly Father's children. Everyone who has been born on the earth is a child of Heavenly Father. We do not remember living with Heavenly Father, but we know we are his children because we read it in the scriptures.

Scripture

Read aloud the last part of Psalm 82:6, beginning with *all of you*. Explain that *the most High* means Heavenly Father.

Explain that all of Heavenly Father's faithful spirit children want to come to earth. Many of his spirit children have been born already, but there are still many waiting to come to earth.

We Have Spirits

Discussion

Display the wordstrip "Spirit."

Explain to the children that when we lived in heaven before we came to earth, we did not have physical bodies. We were spirits.

- What is a spirit?

Explain that our spirits are the part of us that make us alive.

- What do you think your spirit looks like?

Pass around a small mirror and have each child look into it. Ask the children if the mirror gives them any idea what their spirits look like.

Explain that our spirits look like our physical bodies. For example, spirits have eyes, ears, arms, and legs.

Object lesson Place a glove on the table. Explain that even though the glove is shaped like a hand, it cannot move like a hand because it is not alive. When a hand is placed in the glove, then the glove can move. Put your hand into the glove and wiggle your fingers. Explain that the glove is like a physical body, and the hand is like a spirit. Our bodies cannot move without our spirits inside them. Our spirits cannot be seen inside our bodies, just as the hand inside the glove cannot be seen. (See Boyd K. Packer, *Teach Ye Diligently* [Salt Lake City: Deseret Book Co., 1975], p. 231–33.)

We Have Physical Bodies

Discussion Display the wordstrip “Physical Body.”

Explain that when we came to earth, each of us was given a physical body. Have the children name some of the parts of their physical bodies, such as eyes, ears, arms, and legs.

- What can your physical body do?

Activity Let the children name and demonstrate some of the many things their physical bodies can do, such as jumping, hopping, wiggling, talking, crawling, or dancing.

Paper doll discussion Show the children the paper doll chain.

- How are we like these paper dolls? (We also have arms, legs, and heads.)
- How are we different from them? (They are made of paper; we have bodies made of flesh and bone. They aren’t alive; we are alive. They all look alike; we look different from each other.)
- What would it be like if we all looked alike?

Game Ask the children to stand up whenever you make a statement that describes them. Ask them to sit down if the statement does not describe them. Use statements that demonstrate the similarities and differences among the children in your class, such as—

- All the girls stand up.
- Everyone with brown eyes stand up.
- Everyone with a nose stand up.
- Stand up if you have blond hair.

Point out that we all have many things in common, but no two people are exactly alike. Explain that Heavenly Father planned for each of us to have a physical body that is similar to other bodies but not exactly like any other body. Each of us is different from every other person.

We Have Families That Love Us

Teacher presentation Display the wordstrip “Family.”

Tell the children that Heavenly Father loves us so much that he sent each of us to earth to receive a body. He sent us to families who would take care of us and teach us about Heavenly Father and Jesus Christ.

Story

Tell the following story in your own words:

Early one morning a boy and his father began a long hike. They wanted to spend the day together fishing, so they packed their equipment and started hiking toward a small, beautiful lake. They had been walking for a long time when the boy started to get tired and began walking slower and slower.

When the lake came into view, the father hurried ahead to see the beautiful blue waters of the lake. He thought his son would catch up.

When the father got to the lake, he realized that his son had not caught up with him. He could not see his son. The father dropped his pole and searched everywhere for his son. He shouted with all his might, but his son did not answer. The father became frightened. Was his son lost? Was he hurt?

The father knelt down and prayed. He asked Heavenly Father to help him find his son. Then he got up and walked back along the path. Soon he found his son. The father hugged the boy and told him how much he loved him. (Adapted from Owen C. Bennion, "Turning the Heart of a Father," *Ensign*, May 1971, pp. 28–30.)

Discussion

- How did the boy know that his father loved him? (His father took him fishing, searched for him when he was lost, prayed for him, and showed how happy he was to find him.)
- How do you know that your family loves you?

After the children have responded, explain that there are many ways our parents and families show us that they love us.

We Have a Heavenly Father Who Loves Us

Discussion

- How do you know that Heavenly Father loves you?

Song

Tell the children that Heavenly Father loves us and wants us to be happy. He has given us a beautiful world to live in. Sing or say the words to "My Heavenly Father Loves Me," helping the children do the actions indicated:

Whenever I hear (*cup hands around ears*) the song of a bird (*wave arms like wings*)

Or look at the blue, blue sky (*raise arm in arching motion*),

Whenever I feel the rain on my face (*wiggle fingers like raindrops*)

Or the wind as it rushes by (*wave both hands back and forth*),

Whenever I touch a velvet rose (*pretend to smell a flower*)

Or walk by our lilac tree (*walk in place*),

I'm glad that I live in this beautiful world (*outstretch hands and arms*)

Heav'nly Father created for me (*hug self*).

He gave me my eyes that I might see (*point to eyes*)

The color of butterfly wings (*link thumbs and flutter fingers like wings*).

He gave me my ears that I might hear (*point to ears*)

The magical sound of things (*cup hands around ears*).

He gave me my life, my mind (*point to side of head*), my heart (*point to heart*):

I thank him rev'rently (*fold arms*)

For all his creations, of which I'm a part (*outstretch hands and arms*).

Yes, I know Heav'nly Father loves me (*place hands over heart*).

- Discussion
- What things remind you that Heavenly Father loves you?
 - How does it make you feel to know that you are a child of Heavenly Father and he loves you?

Summary

Song Have the children sing the first verse of “I Am a Child of God.” Remind the children that *God* is another name for Heavenly Father.

Point out that the words of the song tell us that each of us is a beloved child of Heavenly Father and that he planned for us to come to earth and receive our physical bodies. He also planned for us to have families to love and teach us so we can return to live with him again.

Testimony Testify that you know Heavenly Father loves us because he has given us physical bodies, a beautiful earth to live on, and families who love us.

Encourage the children to thank Heavenly Father in their prayers tonight for being able to come to earth.

Invite a child to give the closing prayer.

Enrichment Activities

Choose from the following activities those that will work best for the children in your class. You can use them in the lesson itself or as a review or summary. For additional guidance, see “Class Time” in “Helps for the Teacher.”

1. Cut the paper dolls apart and give one to each child. Have the children color or decorate the dolls. When the children are finished, have them show their dolls to the rest of the class. Point out how different and beautiful each paper doll has become. Remind the children that we are similar but that no person is exactly like another person.
2. Have the children sit in a circle. Toss a beanbag or other soft object to a child and ask a question about the lesson. Ask the child to answer the question and toss the beanbag back to you. Repeat until every child has had a turn to answer at least one question. Use the following questions or create your own:
 - Where did we all live before we came to earth? (In heaven.)
 - Whom did we live with? (Heavenly Father and Jesus Christ and everyone.)
 - Where do we live now? (On earth.)
 - What do our spirits look like? (Like our physical bodies.)
3. Give the children paper and pencils or crayons and have them draw pictures of things that remind them that Heavenly Father loves them.
4. Have the children stand and play the game “Teacher Says.” Explain that they are to do what you tell them to do only if you say “Teacher says” before you give the instruction. Ask the children to do actions such as folding their arms, touching their shoulders, and turning around, sometimes saying “Teacher says” before asking and sometimes just asking for the action. If the children do the action when you do *not* say “Teacher says,” they must sit down until the end of the game. Repeat the game as many times as you want.

Remind the children that their physical bodies enable them to do all these actions.

I Chose to Follow Jesus Christ

Purpose

To help each child understand that in the pre-earth life we lived with Heavenly Father and Jesus Christ and chose to follow them.

Preparation

1. Prayerfully study Job 38:7, Moses 4:1–4, Abraham 3:24–28, and Articles of Faith 1:1. See also *Gospel Principles* (31110), chapter 3.
2. Prepare to hum and sing the first verse of “I Am a Child of God” (*Children’s Songbook*, p. 2). The words to this song are included at the back of the manual.
3. Materials needed:
 - a. A Bible and a Pearl of Great Price.
 - b. CTR chart (see lesson 1).
 - c. Picture 2-3, Jesus the Christ (Gospel Art Picture Kit 240; 62572); picture 2-4, The Pre-earth Life.
4. Make the necessary preparations for any enrichment activities you want to use.

Suggested Lesson Development

Invite a child to give the opening prayer.

Follow up with the children if you encouraged them to do something during the week.

We Are Children of God
Attention activity

Tell the children that you are going to hum a song. Ask them to listen carefully and tell you the name of the song when you are finished. Hum “I Am a Child of God.”

- What song did I hum?
- Who does the song say you are?

Have the children sing the first verse of the song.

Review discussion

Remind the children that in the previous lesson you talked about where we lived before we came to earth.

- Where did we live before we came to earth?
- Whom did we live with in heaven?
- What makes us all brothers and sisters? (We are all children of Heavenly Father.)

We Made an Important Choice in Heaven
Teacher presentation

Tell the children that they are going to learn about something very exciting that happened before we were born, while we lived with Heavenly Father.

Show picture 2-4, The Pre-earth Life. Explain that this is one artist's idea of what heaven is like. Explain that in heaven we were all spirits who walked and talked with Heavenly Father. Ask the children to think about what it might have been like to live with Heavenly Father. Help them understand how wonderful it was to be able to see him and be with him.

Tell the children that while we were in heaven, Heavenly Father called us to attend a great meeting. All of Heavenly Father's children were there. Heavenly Father wanted to talk to us.

Explain that Heavenly Father told us that we needed to go away from him for a time in order to get a physical body and learn to choose the right. Heavenly Father told us he would provide a place where we could do these things.

- Where did Heavenly Father want us to go? (To earth.)

Heavenly Father told us that when we came to earth, we would not remember living with him. He also said we would need someone to help us return to heaven to live with him again after our time on earth was finished. He promised to send someone to help us.

Discussion

- How does it make you feel to know that Heavenly Father loved you enough to send someone to help you get back to heaven to live with him again?

Explain that when Heavenly Father told us that he was going to send someone to help us, we all shouted for joy (see Job 38:7).

Show picture 2-3, Jesus the Christ.

- Who is this?

Explain that Jesus Christ lived in heaven with us. He is the firstborn of our Heavenly Father's spirit children.

Article of faith

Tell the children that as a church we have statements called the Articles of Faith that tell what we believe. Help the children memorize the first part of the first article of faith: "We believe in God, the Eternal Father, and in His Son, Jesus Christ."

Tell the children that *God, the Eternal Father* is another name for Heavenly Father.

Scripture story and discussion

Tell the children that Heavenly Father asked whom he should send to teach us. Open the Pearl of Great Price to Abraham 3:27 and read aloud what Jesus answered: "Here am I, send me." Jesus said he would do whatever Heavenly Father wanted him to do to help us. Read aloud the last part of Moses 4:2 (from *Father*). Jesus also said that he would give all the glory to Heavenly Father. Explain briefly the meaning of *glory*.

- How can you tell that Jesus loved Heavenly Father? (He was willing to do what Heavenly Father wanted him to do.)
- Whom else does Jesus love? (Us.)

Emphasize Jesus' love for Heavenly Father and for us by reviewing what Jesus was willing to do.

Jesus Christ was willing to—

- Come to earth to help us.
- Testify of Heavenly Father.

- Teach us the right way to live and be happy.
- Show us what to do so we can live with Heavenly Father again.
- Give his life for us.

Point out that another spirit son whose name was Lucifer also wanted to be sent to earth to help us. He told Heavenly Father that he would come to earth and force all of us to do what is right. He wouldn't let us choose for ourselves. Lucifer wanted Heavenly Father to give him all the honor and glory.

Read aloud Heavenly Father's decision from Abraham 3:27: "I will send the first."

- Whom did Heavenly Father choose to help him?

Explain that Lucifer became very angry that he wasn't chosen. He did not accept Heavenly Father's plan. Instead, Lucifer caused a great war in heaven. It was not a war of guns and bombs, but a war of talking and trying to get people to follow him. Lucifer convinced some of our spirit brothers and sisters that his evil ideas were good, and they chose to follow him instead of Jesus.

Tell the children that Lucifer is also called Satan, or the devil.

Discussion

- Whom did you choose to follow, Jesus or Satan?

Ask the children to stand if they chose to follow Jesus. Explain that all of them chose to follow Jesus, so they should all be standing.

Explain that we know we followed Jesus because we are here on earth. The spirits who followed Satan were not allowed to be born on earth and receive physical bodies.

Tell the children how happy you are that you chose to follow Jesus. Tell them that you are proud of them because they chose to follow Jesus and not Satan. Praise the children for choosing the right.

We Want to Continue to Follow Jesus Christ

Teacher presentation

Emphasize to the children that they were not forced to follow Jesus. They had a choice. They could have followed Satan. But they chose the right way.

Tell the children that they have the same choice in this life on earth. Satan is still trying to get us to follow him. Heavenly Father wants us to follow Jesus because that will make us happy and enable us to live with Heavenly Father and Jesus again. But we are not forced to follow Jesus. We can choose whether we do the good things Jesus wants us to do or the bad things Satan wants us to do.

CTR chart

Show the CTR chart. Ask the children who is in the picture on the chart. Read the words on the chart as you point to them. Then have the children say with you, "I will choose the right."

Discussion

Let the children respond to the following questions (or some you have created) about what they would do to follow Jesus:

- If you choose to follow Jesus, what could you do if you accidentally hurt someone?
- If you choose to follow Jesus, how will you act in this class? (Have the children demonstrate actions such as sitting quietly, listening, participating appropriately, and not disturbing other children.)

- If you choose to follow Jesus, what could you do or say if someone gives you a gift or does something for you?
- If you choose to follow Jesus, how will you treat someone who has been unkind to you?

Refer again to the CTR chart and have the children repeat the words on it.

Summary

Testimony

Bear testimony that before we came to earth, each of us made a choice. We chose to follow Jesus Christ, and we will again live with him and Heavenly Father if we do what Jesus has taught us to do.

Explain that each week in Primary the children will learn about things Jesus wants us to do.

Encourage the children to thank Heavenly Father in their prayers for sending Jesus to earth to be our Savior. Suggest that they ask Heavenly Father to help them make right choices so they can live with him and Jesus again someday.

Invite a child to give the closing prayer.

Enrichment Activities

Choose from the following activities those that will work best for the children in your class. You can use them in the lesson itself or as a review or summary. For additional guidance, see “Class Time” in “Helps for the Teacher.”

1. Have the children look at their CTR rings. If the children are not wearing CTR rings, you may wish to tie a piece of string around each child’s finger like a ring. Tell the children that their rings will remind them that they chose to follow Jesus and that they should continue to make right choices.
2. Sing or say the words to the first verse of “I Lived in Heaven” (*Children’s Songbook*, p. 4):

I lived in heaven a long time ago, it is true;
Lived there and loved there with people I know. So did you.
Then Heav’nly Father presented a beautiful plan,
All about earth and eternal salvation for man.

After you sing, ask questions such as the following about what the song says (repeat the lines of the song as necessary to help the children with the answers):

- Where does the song say you lived? When did you live there?
- Whom did you live with there?
- What did Heavenly Father do while we were in heaven with him?
- What was the plan about?

Sing the second verse of the song and ask similar questions:

Father said he needed someone who had enough love
To give his life so we all could return there above.
There was another who sought for the honor divine.
Jesus said, “Father, send me, and the glory be thine.”
(© 1987 by Janeen Jacobs Brady. Used by permission.)

3. Have the children draw pictures of what they think heaven is like.
4. Sing or say the words to "He Sent His Son" (*Children's Songbook*, p. 34) or "I Will Follow God's Plan" (*Children's Songbook*, p. 164). The words to "He Sent His Son" are included at the back of the manual.

I Will Follow God's Plan

My life is a gift; my life has a plan.
My life has a purpose; in heav'n it began.
My choice was to come to this lovely home on earth
And seek for God's light to direct me from birth.
I will follow God's plan for me,
Holding fast to his word and his love.
I will work, and I will pray;
I will always walk in his way.
Then I will be happy on earth
And in my home above.

I Can Make Right Choices

Lesson

5

Purpose To help each child understand that we can choose the right because Heavenly Father gave us agency.

Preparation

1. Prayerfully study Matthew 21:14–16 and Doctrine and Covenants 37:4. See also *Gospel Principles* (31110), chapter 4.
2. Prepare to sing or say the words to “Choose the Right Way” (*Children’s Songbook*, p. 160). The words to this song are included at the back of the manual.
3. If you want to use enrichment activity 1 from lesson 6 next week (see page 28), prepare a note similar to the following for each child to take home to his or her parents:

Please tell [child’s name] how his [her] first name was chosen so we can talk about it next time in class. Thank you.

If you want to use enrichment activity 2 from lesson 6 next week, prepare a note asking each child’s parents to send a family photograph with their child next week (this can be the same note as above if you are using both activities).

4. Materials needed:
 - a. A Bible and a copy of the Doctrine and Covenants.
 - b. CTR chart (see lesson 1).
 - c. A bowl of small items of different colors, such as candies or shiny rocks. Have enough of each color so each child will have a choice of several colors.
 5. Make the necessary preparations for any enrichment activities you want to use.
-

Suggested

Lesson

Development

Invite a child to give the opening prayer.

Follow up with the children if you encouraged them to do something during the week.

Heavenly Father and Jesus Christ Want Us to Choose for Ourselves

Attention activity

Show the bowl of small items and let each child choose one. Tell the children that they have just made a choice. We must make many choices every day.

- What choices have you made today? (Answers might include choosing what to wear, choosing what to eat for breakfast, or choosing what to do with free time.)

Tell the children that making choices is a very important part of life on earth. Some choices are easy and some choices are hard. Our right to choose was given to us when we lived in heaven with Heavenly Father and Jesus Christ.

Teacher presentation	<p>Remind the children that before we came to earth, Heavenly Father called us to a meeting. See if the children remember from the previous lesson what happened at that meeting. If they do not, quickly review, bringing out the following ideas:</p> <p>At this meeting Heavenly Father presented a plan to help us become like him. We chose to follow the plan, so we each came to earth and received a physical body. If we choose to keep the commandments while we are on the earth, we will be able to live with Heavenly Father again. Jesus Christ offered to come to earth to show us what we must do to live with Heavenly Father again. Lucifer wanted to come to earth and force everyone to keep the commandments. He did not want to give people any choices. But Jesus wanted to follow Heavenly Father's plan. He wanted people to be able to choose how they would live.</p> <p>Explain that Heavenly Father knew it would be best for us to choose for ourselves so we could learn to make right choices. Being able to choose for ourselves is called agency. Have the children say the word <i>agency</i> aloud a couple of times.</p> <p>Explain that Lucifer (who is also called Satan) and his followers are still fighting Heavenly Father's plan. They want us to use our agency to choose to follow them instead of following Jesus and doing what is right.</p>
CTR chart	<p>Display the CTR chart.</p> <ul style="list-style-type: none"> • What did Jesus want to do to help us choose the right? (He wanted to come to earth to teach us what is right so we would be able to choose wisely.) <p>Point to the words on the CTR chart. Say the words aloud, and then have the children repeat them with you.</p>
Children Can Choose to Do Right	
Scripture story	<p>In your own words, tell the story found in Matthew 21:14–16. Explain that some of the chief priests did not believe that Jesus Christ was the Savior, the one Heavenly Father had sent to help them. They watched Jesus closely to try to find him doing something wrong so they could have him killed.</p> <p>Explain that when Jesus healed the blind and lame people in the temple, the chief priests were angry. When the children began praising Jesus, the priests were even more angry, and they wanted Jesus to stop the children. But instead he asked the priests if they had not read in the scriptures that little children would praise him.</p> <p>Point out that just like the children in this story, the children in your class can choose to follow and praise Jesus.</p>
Scripture	<p>Open the Doctrine and Covenants and read aloud part of Doctrine and Covenants 37:4: "Let every man choose for himself." Explain that in this scripture, <i>every man</i> means all people. We can all choose what we do. Have the children stand and repeat the phrase.</p>
CTR chart	<p>Point to the CTR chart and have the children repeat the words on the chart again.</p>
We Can Choose the Right	
Story	<p>Tell the children a story about a child who chose to do what Jesus would want. You may want to use the following story:</p>

Brittany woke up Sunday morning feeling grumpy. She had gone to bed too late and had to get up too early. She had to wait for her turn in the bathroom. Then she couldn't find one of her shoes. Then she stubbed her toe on a chair. Her big brother was angry with her because he thought she was going to make the whole family late.

At Primary Brittany didn't sing. She didn't smile. She didn't even listen. She wished she weren't at Primary. She sat on the back row and frowned and played with some things in her pocket.

- What choices did Brittany make?

Brittany's teacher had worked hard to prepare the lesson and knew that Brittany was not listening. After class Brittany's teacher talked to Brittany alone and asked what the problem was. Brittany started to cry. She wanted to be happy, and she wanted her teacher to be happy too.

Brittany's teacher asked if she would like to try an experiment. Brittany thought an experiment sounded like fun. Her teacher explained that choosing the right and doing what Jesus wants us to do can help us be happy. Brittany agreed to try to do what Jesus would have her do at Primary next Sunday.

The following Saturday, Brittany's teacher reminded her about the experiment. Brittany said to herself, "Tomorrow I'm going to do what Jesus wants me to do."

Sunday morning when Brittany woke up, she was excited to try the experiment. She quickly got ready for church and helped her sister get ready also. When Brittany got to Primary, she was smiling. She sang the opening song and sat reverently during the opening prayer. The boy sitting next to Brittany kept whispering to her, and soon Brittany was whispering back and not listening. Just before it was time to go to class, Brittany looked up and saw the picture of Jesus on the wall. She remembered that she wanted to do what Jesus wanted her to do. Brittany walked quietly to class and sat on the front row. She listened to the lesson and answered the questions her teacher asked her. Brittany felt happy. She was glad she chose the right. She discovered that choosing the right and doing what Jesus wanted her to do made her feel happy.

Discussion

- Why did Brittany feel happy?
- When have you felt happy because you chose the right?

Summary

Activity

Have the children each make a hand into a fist with the thumb pointing out. Tell the children that you are going to describe some choices they might make. If the choice described is something Jesus would have them do, they should point their thumbs up. If the statement describes something Satan would have them do, they should point their thumbs down. Use the following examples or create some of your own:

- You choose to come to Primary.
- You choose to sing in Primary when the leader asks everyone to sing.
- You choose to keep your eyes open during the prayer.
- You choose to bring a friend to church.
- You choose to whisper to your friend during the sacrament.

- You choose to walk quietly to your classroom.
- You choose to laugh when another child stumbles and falls.
- You choose to disturb the other children by making noises.
- You choose to help the teacher with the activity.
- You choose to make fun of someone who answered a question wrong.
- You choose to listen quietly when the teacher tells a story.

Song

Lead the children in singing or saying the words to “Choose the Right Way.”

Testimony

Tell the children how grateful you are that Heavenly Father has given us agency. Express your confidence in the children’s ability to make right choices.

Ask the children to be ready to tell the class next week about a right choice each of them made during the week.

Handout

If you have prepared notes for the children concerning next week’s lesson, give each child a note. Explain the notes to the children and tell them to give the notes to their parents.

Invite a child to give the closing prayer.

Enrichment Activities

Choose from the following activities those that will work best for the children in your class. You can use them in the lesson itself or as a review or summary. For additional guidance, see “Class Time” in “Helps for the Teacher.”

1. Have all the children stand. Choose one child to be the leader, and give him or her a coin or button. Have the leader stand in front of the class with the coin hidden in one of his or her hands. Let the other children in the class guess which hand the coin is in. When everyone has guessed, the leader reveals which hand the coin is in. The children who guessed correctly take one step toward the leader. The others remain where they are. Continue until a child reaches the leader.

- Why didn’t all of you guess correctly every time? (You didn’t have any information to help you guess.)
- Is guessing a good way to make choices?

Help the children understand that we do not have to guess about our decisions. Jesus has taught us what we should do. If we do what Heavenly Father and Jesus want us to do, we will always make right choices.

2. Give the children paper and crayons and have them draw pictures of themselves doing things Jesus Christ would have them do in Primary. Examples might be sitting quietly, singing, helping the teacher, or walking quietly.

3. Help the children sing or say the words to “Listen, Listen” (*Children’s Songbook*, p. 107), using the actions indicated:

Listen to the still small voice (*put hand to ear*)!

Listen! Listen (*put finger to lips*)!

When you have to make a choice (*hold hands out, palms up*).

He will guide you always (*fold arms*).

Repeat the song several times to help the children learn the words.

We Have Special Families

Lesson

6

Purpose To help each child understand that Heavenly Father planned for children to grow up in families.

Preparation

1. Prayerfully study Luke 1:26–38 and Matthew 1:18–25.
2. Cut the following letters out of paper. Make each letter about three or four inches high:

FAMILY

3. Prepare to sing or say the words to “A Happy Family” (*Children’s Songbook*, p. 198). The words to this song are included at the back of the manual.
4. Materials needed:
 - a. A Bible.
 - b. A picture of your family (optional).
 - c. Paper and pencils or crayons.
 - d. Picture 2-5, The Annunciation; picture 2-6, The Nativity (Gospel Art Picture Kit 201; 62495).
5. Make the necessary preparations for any enrichment activities you want to use.

Note: Be sensitive to class members’ family situations. Help the children understand that the most important thing about a family is not the number of people in the family but that the family members love and care for each other.

**Suggested
Lesson
Development**

Invite a child to give the opening prayer.

Follow up with the children if you encouraged them to do something during the week. You may want to invite each child to tell about a time during the past week when he or she chose the right.

Families Are a Part of Heavenly Father’s Plan

Attention activity

- Where did you live before you came to earth?

Review with the children that each of us chose to follow Heavenly Father’s plan and come to earth. Tell the children that when we came to earth, Heavenly Father blessed us with people to help us and love us.

Tell the children that you will give them clues to help them figure out who these people are. One at a time, have a child hold up each letter of the word *family*. Have the children state the name of the letter. Then give a clue that starts with that letter. Some possible clues are given on the next page.

1. **F**ather is a part of it.
2. **A**unts and uncles are part of it.
3. **M**other is a part of it.
4. **I** am a part of it.
5. **L**ove is a part of it.
6. **Y**ou are a part of it.

When you have given all the clues, repeat the word *family* together with the children.

Discussion

- Why do we need families?

Explain that when we were babies we needed to live with people who would take care of us. Heavenly Father planned for each of us to live with a family that would love us and take care of us. As we grow older, our families also teach us and help us make wise choices.

Heavenly Father Planned for Jesus Christ to Be Born into a Family

Scripture story and discussion

Explain that Heavenly Father planned for Jesus Christ to be born into a family. The man and woman chosen to love and care for Jesus on earth loved Heavenly Father and kept his commandments.

Show picture 2-5, The Annunciation, and tell the story of the angel Gabriel's visit to Mary, as found in Luke 1:26–38.

- Who is the woman in this picture? (See Luke 1:27.)
- Who is the man in this picture? (See Luke 1:26.)

Explain that Mary was surprised and a little worried when she saw the angel, but she was willing to do whatever Heavenly Father wanted her to do (see Luke 1:29, 38).

- What did the angel tell Mary? (See Luke 1:31–32.)
- Who would be the baby's father? (Heavenly Father.)

Show picture 2-6, The Nativity.

- Who is the man in this picture?

Tell the children that Joseph was a righteous man chosen by Heavenly Father to marry Jesus' mother and love and care for Jesus. Explain that an angel also visited Joseph before Jesus was born. Briefly tell the story found in Matthew 1:18–25. Read aloud what the angel told Joseph in Matthew 1:21.

- What did the angel tell Mary and Joseph to name the baby?

Explain that the name *Jesus* means savior. Jesus Christ would save all of us from our sins and help us return to live with Heavenly Father forever. The prophets who lived on the earth before Jesus was born foretold that our Savior's name would be Jesus Christ. The word *Christ* means "anointed one," which means chosen by Heavenly Father.

- Why did Jesus need a family?

Our Families Love Us

Teacher presentation	Explain that all families are different. Some families have two parents, and some families have only one. Some families have lots of children, and some families have only a few children or one child. Some families have children, parents, grandparents, aunts, and uncles all living together. Some children live with adults who aren't related to them but who still love them and care for them. Families do different things together and show love in different ways. The important thing about families is that the family members love and care for each other. Everyone needs to be part of a family.
Discussion	<ul style="list-style-type: none"> • What did your family do for you when you were a baby? • What does your family do for you now? • What do you do for other members of your family?
Child participation	Show the picture of your family, if you brought one. Point out the members of your family and tell why each one is important to you. Let the children talk about their families. Invite the children to tell about times they felt happy because they knew their families loved them.

Our Families Help Us

Discussion	<p>Ask the children to listen while you give a few examples of family members helping and loving one another. After you give each example, ask the children to tell how the people in the example showed love for each other. Use the following examples or create some of your own:</p> <ul style="list-style-type: none"> • Kirk's little brother Eric was afraid at night, so Kirk helped him say a prayer to feel safe. Then Kirk sang a song to help Eric go to sleep. • Kaitlin's mother had been gone overnight. Kaitlin cut a piece of paper into a heart shape and wrote a message telling her mother how much she loved her. She left the message on her mother's pillow for her mother to find when she came home. • Ian's grandmother took time every week to help Ian practice his spelling words for school. Her help and praise encouraged him to learn all the words on his list. • Tony set a goal to read the Book of Mormon before he was baptized. Every night his older sister sat with him and listened as he read. She helped Tony with the hard words. With his sister's help, Tony was able to meet his goal. • Heidi overheard some of her classmates teasing her younger brother. He was nearly in tears, so Heidi took him away and played a game with him. Later she told her classmates that they should not tease other children.
Object lesson	Hold up your hand with the fingers extended. Explain that the members of a family can work together like the fingers and thumb of a hand. Ask the children to try to pick up their scriptures or some other object with one hand, without using their thumbs. Explain that while they may be able to pick up the object with just their fingers, it is much easier when they use their thumb and fingers together. Remind the children that every member of a family is important. Family members can accomplish much when they all work together.
Art activity	Give the children paper and crayons or pencils and have them draw pictures of their families. Label each picture <i>My Family Loves Me</i> .

Summary

Song	With the children, sing or say the words to “A Happy Family.”
Testimony	<p>Bear testimony that Heavenly Father wants each of us to be loved and taken care of by a family. Remind the children that every family is different and every family is important. Testify that they can do much to help their families be happy.</p> <p>Encourage the children to show their families the pictures they drew and to tell their families how much they love them.</p> <p>Invite a child to give the closing prayer. Ask the child to thank Heavenly Father for families.</p>

Enrichment Activities

Choose from the following activities those that will work best for the children in your class. You can use them in the lesson itself or as a review or summary. For additional guidance, see “Class Time” in “Helps for the Teacher.”

1. If it would be meaningful in your culture, have each child come prepared to tell how his or her first name was chosen. This can be done by sending a note to the children’s parents at the end of lesson 5, asking the parents to tell their child how his or her name was chosen (see page 21). In class, explain that when we were born, our families chose names for us. Have each child tell the other children how his or her name was chosen. (If possible, you may want to contact each child’s parents during the week to remind them to have their child come prepared to tell how his or her first name was chosen.)
2. Arrange for each child to bring a picture of his or her family from home (collect these at the beginning of class so they will not be a distraction). One at a time, let the children show the pictures and tell one or two things they like about their families. (If you plan to use enrichment activity 1 also, you may add the request for a family picture to the note sent home at the end of lesson 5.)
3. With the children, sing or say the words to “Here We Are Together” (*Children’s Songbook*, p. 261), using the titles of family members:

Here we are together, together, together;
Oh, here we are together in our family.
There’s father and mother and sister and brother;
Oh, here we are together this bright, sunny day.

Sing additional verses using titles such as *grandma*, *grandpa*, *aunt*, and *uncle* so all family members are named.

Remind the children that Heavenly Father planned for them to live with families that would love and help them.
4. Have each child trace around his or her hand on a piece of paper. Have the children draw faces on the fingers to represent family members or put a heart in the middle to show love. Remind the children that the members of a family are like the fingers on a hand: each one is important.
5. Let the children role-play situations that demonstrate how family members can help one another. Use the situations from the lesson or create some of your own.

6. Help the children do the actions to the following verse while you say the words:

My Family

Just like the birds way up in the tree (*flap arms like wings*),
 I have my very own family (*point to self*).
 They give me food (*pretend to eat*)
 And teach me to play (*jump*),
 So I can be safe and happy all day (*smile a big smile*).

7. Sing or say the following words (they can be sung to the tune of "The Farmer in the Dell") as the children join hands and walk in a circle:

Your family loves you well;
 Your family loves you well;
 Heigh ho the family-oh!
 Your family loves you well.

Choose a child to stand in the middle of the circle as you sing the next verse:

This family has a father,
 This family has a father;
 Heigh ho the family-oh!
 This family has a father.

Repeat this verse, replacing *father* with *mother* and having another child join the first in the center of the circle. Continue, using the names of other family members, until every child is standing in the center. Sing the first verse once more when all the children are standing together.

The Birth of Jesus Christ Brought Joy to the Earth

Purpose To help each child feel the joy that Jesus Christ's birth brought to the earth.

Preparation

1. Prayerfully study Luke 2:1–20.
2. Bring a twelve-month calendar or make a time line for the birthday activity. To make a time line, divide a long strip of paper into twelve equal sections and write the names of the months, in order, one in each section.
3. Find out the birthday of each child in your class by asking the Primary secretary, the ward clerk, or the children's parents.
4. With the approval of your Primary president, invite a mother or expectant mother to briefly tell the children how she prepares for the birth of a baby. Ask her to include her feelings of excitement.
5. Prepare to sing or say the words to the first verse of "Far, Far Away on Judea's Plains" (*Hymns*, no. 212).
6. Materials needed:
 - a. A Bible.
 - b. A small piece of paper and a pencil for each child.
 - c. Tape or other adhesive.
 - d. Picture 2-6, The Nativity (Gospel Art Picture Kit 201; 62495).
7. Make the necessary preparations for any enrichment activities you want to use.

Note: As you discuss the children's births, be sensitive to the feelings of any adopted or foster children in your class. Make sure they understand that their births were also joyful events.

Suggested Lesson Development

Invite a child to give the opening prayer.

Follow up with the children if you encouraged them to do something during the week.

Birthdays Are Special

Attention activity

Tell the children that you are thinking of a special day. Explain that you will give them a clue, and ask them to listen to the clue and raise their hands when they know what day you're thinking of. Hum a birthday song such as "Happy Birthday" or give some other obvious clue.

- What special day am I thinking of?
- What do you like best about your birthday?

Calendar or time line activity	<p>Pass out the paper and pencils. Have each child write his or her name on a piece of paper. (Help the children as necessary.)</p> <p>Display the calendar or time line. Invite the children to say the names of the months with you as you read them. Read the name of each month again, one at a time, and invite any children who have birthdays in that month to tape their names on the calendar or time line.</p> <ul style="list-style-type: none"> • How do you think your family felt when you were born?
Guest speaker	<p>Introduce the mother or expectant mother, and have her express her feelings about preparing for the birth of a baby.</p>
Discussion	<p>Talk with the children about things their families might have done to prepare for their births, such as praying for them to be healthy, choosing names, obtaining baby clothes and other supplies, and planning a place for them to sleep. Help the children feel that their births were joyful and exciting events. If you are a parent, you may want to tell about what you did and the feelings you had when a baby was born into your family.</p> <p>Remind the children that being born and receiving a physical body is an important part of Heavenly Father's plan for us.</p>

Jesus Christ's Birthday Was a Wonderful Day

Teacher presentation	<p>Tell the children that they are going to learn about the birth of a baby for whom people had been waiting many years. Long ago the prophets said that one day a savior would be born. He would make it possible for people to return to live with Heavenly Father again. The people waited and waited for the birth of this baby.</p> <ul style="list-style-type: none"> • Who was this baby? (Jesus Christ.) <p>Point out that no one knew exactly when Jesus would be born. Some parents taught their children to look forward to this great event because they knew Jesus would show the right way to live and then make it possible for everyone to return to live with Heavenly Father. Without Jesus as our Savior, no one would be able to live with Heavenly Father again.</p>
Preparation for dramatization	<p>Invite the children to pretend that they lived long ago, before the birth of Jesus Christ. Tell them that they are children living near the city of Bethlehem. Their parents have taught them to look forward to the birth of the Savior. Tonight they are out in the fields, helping their fathers tend their sheep.</p> <ul style="list-style-type: none"> • What will you take with you as you go with your fathers to tend the sheep? (Answers may include something warm to wear or something to eat.) <p>Have the children close their eyes and imagine the following scene:</p> <p>Evening is coming, and the shepherds are gathering the sheep into the sheepfold, where they can sleep quietly until morning. The night is clear and the stars are starting to come out. Soon the sky is filled with bright stars. Everything is peaceful and quiet. (You may want to turn down the lights in the classroom to simulate nighttime.)</p>
Scripture story and dramatization	<p>Tell the story of the angel's appearance to the shepherds, as found in Luke 2:8–18. Read aloud a few verses from the Bible as you tell the story.</p>

Point out that the shepherds were afraid when they saw the angel, but the angel told them, “Fear not: for, behold, I bring you good tidings [news] of great joy” (Luke 2:10).

Have the children pantomime being afraid to see the angel, then happy to hear what the angel had to say.

Explain that the angel told the shepherds about the birth of Jesus (see Luke 2:11) and told them where to find the baby Jesus (see Luke 2:12). Then suddenly the shepherds heard many angels “praising God, and saying, Glory to God in the highest, and on earth peace, good will toward men” (Luke 2:13–14).

Song

Sing or say the words to the first verse of “Far, Far Away on Judea’s Plains.” Invite the children to join you if they know the words.

Far, far away on Judea’s plains,
Shepherds of old heard the joyous strains:
Glory to God, Glory to God,
Glory to God in the highest;
Peace on earth, goodwill to men;
Peace on earth, goodwill to men!

Scripture story
and dramatization
continued

Explain that when the angels had gone back into heaven, the shepherds decided to go find the baby Jesus (see Luke 2:15). Have the children pretend to go with their fathers to Bethlehem to see the baby Jesus (you may want to move to another area in the classroom).

Show picture 2-6, The Nativity.

- Who are the people in this picture?

Explain that the shepherds found the baby just as the angel had told them they would. He was wrapped in swaddling clothes and lying in a manger (you may want to explain that *swaddling clothes* means that the baby was dressed in a piece of cloth wrapped around him). The shepherds were grateful for the many things they were allowed to see and hear about Jesus, and they told other people about what they had seen and heard (see Luke 2:17–18).

Summary

Child participation

Invite each child to stand and tell about one thing that happened that night while the shepherds were tending their sheep. Emphasize that many people were very happy after waiting so long for the Savior’s birth.

Testimony

Tell the children how happy you are that Jesus Christ came to earth. Bear your testimony that Jesus is the Savior of the world, and tell the children that following Jesus’ teachings will help us return to live with Heavenly Father someday.

Encourage the children to go home and tell their families what they have learned about the birth of Jesus Christ.

Invite a child to give the closing prayer. Suggest that the child express gratitude for Jesus’ birth.

**Enrichment
Activities**

Choose from the following activities those that will work best for the children in your class. You can use them in the lesson itself or as a review or summary. For additional guidance, see “Class Time” in “Helps for the Teacher.”

1. Help the children act out the events surrounding the birth of the Savior. You may want to bring some simple props, such as scarves and a baby doll.
2. Help the children say the words and do the actions to “Once I Was a Baby” (the words can be sung to the tune of “Once There Was a Snowman,” *Children’s Songbook*, p. 249). Use crouching actions for the first verse and stretching actions for the second verse.

Once I was a baby, baby, baby.
Once I was a baby, small, small, small.

Now I’m growing bigger, bigger, bigger.
Now I’m growing bigger, tall, tall, tall.
3. Sing or say the words to “Away in a Manger” (*Children’s Songbook*, p. 42), “Mary’s Lullaby” (*Children’s Songbook*, p. 44), or “Oh, Hush Thee, My Baby” (*Children’s Songbook*, p. 48). The words to these songs are included at the back of the manual.
4. Make a tracing or copy of the illustrations of baby Jesus and the manger (found at the end of the lesson) for each child. Let each child color a manger and glue some hay, dried grass, or yarn on it to make a soft bed for the baby. Then have each child color the picture of baby Jesus. Help the children cut out their pictures of baby Jesus and glue them to the mangers.

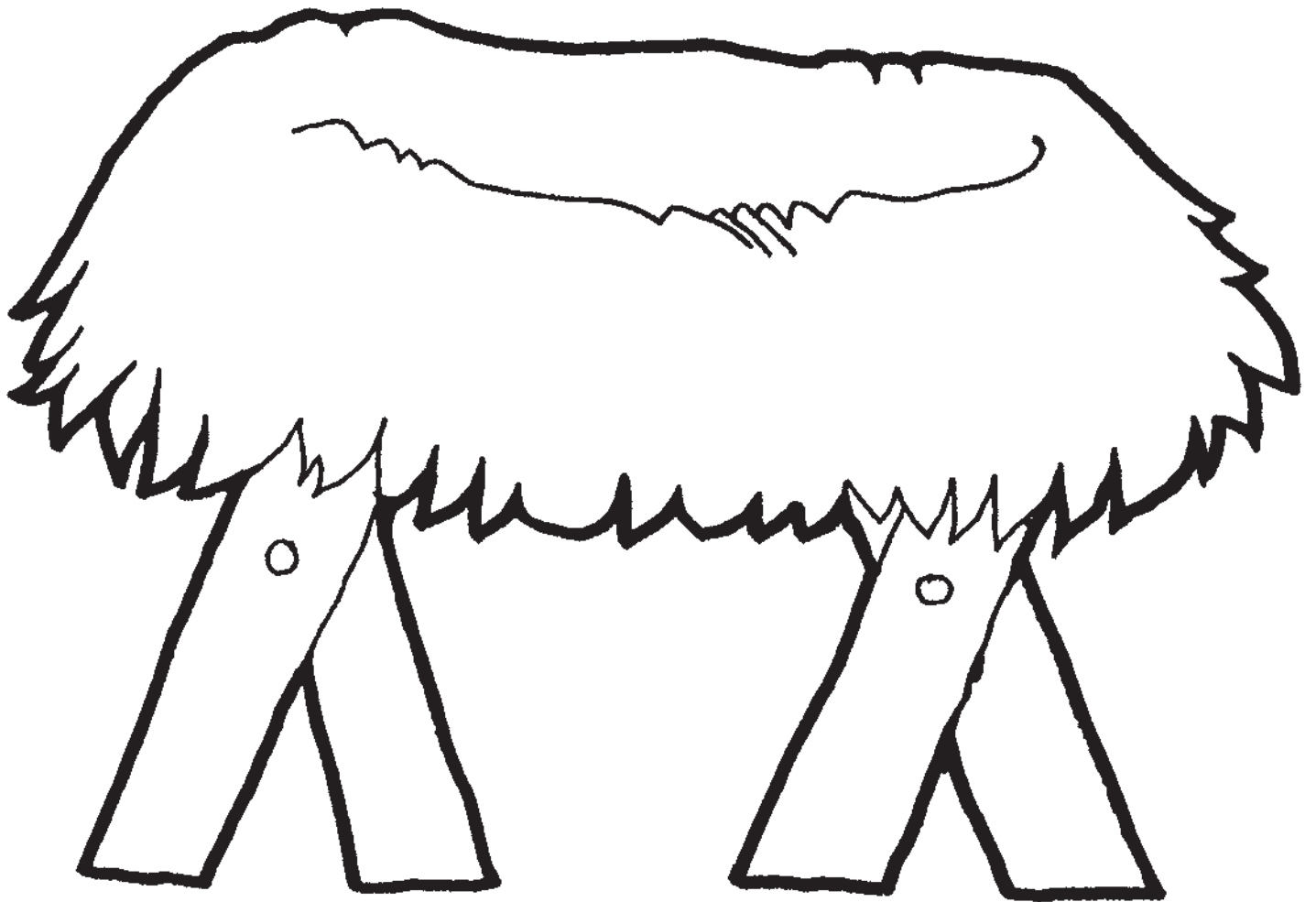
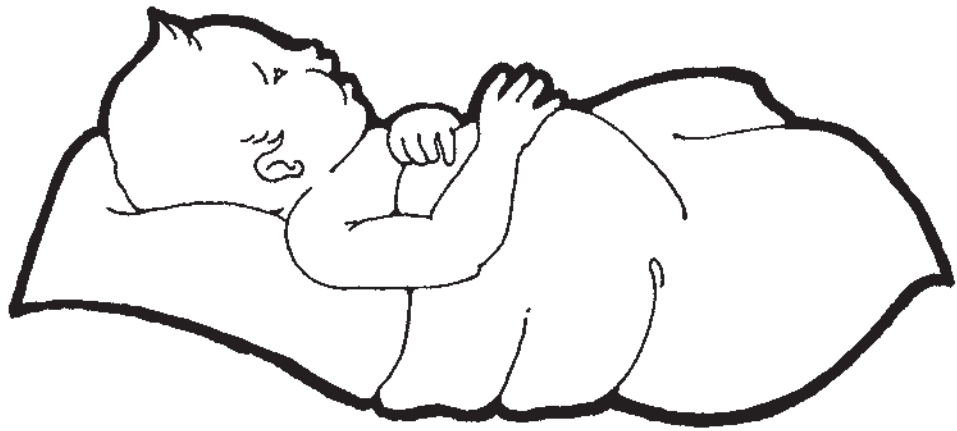

Heavenly Father Watches Over Me

Lesson

8

Purpose To strengthen each child's faith that Heavenly Father will help and bless us in time of need.

- Preparation**
1. Prayerfully study Matthew 2:1–15, 19–20.
 2. Make for each child a paper circle that is large enough for the child to draw a picture of his or her face on it. Punch a hole in the top of each circle and write *Heavenly Father Watches Over Me* around the edge of the circle.
 3. Prepare to share a personal experience when you felt that Heavenly Father was watching over and protecting you, such as when you were protected from an accident, when you had to solve a problem, or when you needed comfort. Or, with the approval of your Primary president, invite a member of your ward or branch to come to your class and share such an experience.
 4. Prepare to sing or say the words to "I Thank Thee, Dear Father" (*Children's Songbook*, p. 7). The words to this song are included at the back of the manual.
 5. Materials needed:
 - a. A Bible.
 - b. A small gift for each child, such as a flower, a pretty stone, or a short note of appreciation.
 - c. Crayons or pencils.
 - d. A long piece of yarn for each child.
 - e. Picture 2-7, The Wise Men (Gospel Art Picture Kit 203; 62120); picture 2-8, Flight into Egypt (Gospel Art Picture Kit 204; 62119); picture 2-9, David O. McKay as a Boy.
 6. Make the necessary preparations for any enrichment activities you want to use.
-

Suggested Lesson Development

Invite a child to give the opening prayer.

Follow up with the children if you encouraged them to do something during the week.

Heavenly Father Does Many Things for Us

Attention activity

Ask the children to close their eyes. Put a small gift on each child's lap and then ask the children to open their eyes. Allow them a moment to talk about the pleasant surprise.

- Who do you think put this gift on your lap?
- Why do you think I gave you a gift?
- Who else does nice things for you? (Parents, family, friends, Heavenly Father.)

- What has Heavenly Father done for you? (Answers might include planning for us to come to earth, giving us families, and sending Jesus Christ to earth to be our Savior.)

Song

With the children, sing or say the words to “I Thank Thee, Dear Father.”

Explain that one thing Heavenly Father does for us is protect and comfort us when we have problems. If we have faith in Heavenly Father, he will give us courage and help us make good decisions about how to handle our problems.

Heavenly Father Protected Baby Jesus

Scripture story

Display picture 2-7, The Wise Men. Tell the story of the Wise Men seeking the Christ child, as found in Matthew 2:1–12.

Explain that King Herod told the Wise Men that he wanted to worship, or show love for, the Christ child (you may want to explain that *the Christ child* is another name for baby Jesus). But King Herod really meant to harm Jesus. Read aloud Matthew 2:12 and explain that Heavenly Father protected Jesus by telling the Wise Men not to go back to King Herod.

Scripture story

Display picture 2-8, Flight into Egypt. Tell the story found in Matthew 2:13–15. Read aloud verse 13 and explain that to destroy means to kill.

- Why did the angel appear to Joseph? (See Matthew 2:13.)
- Why did the angel tell Joseph to go to Egypt? (So King Herod would not be able to find Jesus.)
- Why did King Herod want to kill baby Jesus? (He was afraid Jesus would grow up to take his place as king.)

Explain that Heavenly Father watched over and protected Jesus by warning Joseph to take Jesus and Mary to Egypt. Heavenly Father always watched over Jesus.

Read aloud Matthew 2:19–20.

- Why did the angel appear to Joseph again? (See Matthew 2:20.)
- Why was it safe for Joseph, Mary, and the baby Jesus to return to Israel? (King Herod had died. See Matthew 2:19–20.)

Heavenly Father Watches Over Us

Discussion

Remind the children that each of us is a child of Heavenly Father. He watches over us just as he watched over Jesus. When we obey his commandments and ask for his help, Heavenly Father will help us. (You may want to point out that Heavenly Father always helps us, but sometimes he does not help us exactly as we expect him to.)

- How can you ask for Heavenly Father’s help? (Pray.)
- How might Heavenly Father help you when you are sick? when you are lonely? when you are frightened?

Story

Show picture 2-9, David O. McKay as a Boy. Point out David O. McKay (he is sitting on his father’s lap) and tell the children that this boy grew up to become the ninth President of the Church. Tell the following story about an experience he had when he was a little boy:

“One night while his father was gone, David . . . heard noises around the house and felt sure there were burglars. He knew his mother would be frightened too if she heard [the noises], and he hoped that she would not. As he lay there wide awake, . . . he decided to do what his parents had taught him to do—pray. He had always said his prayers kneeling at his bedside, so he felt that now too he must get out of bed and kneel down to pray. Climbing out of bed was a terrible test; it took all his strength and willpower because he was so frightened. But he did it!

“As he knelt down by the side of the bed, he prayed earnestly and with real faith. Then, just as clearly as one person speaks aloud to another, he heard a voice say to him, ‘Don’t be afraid. Nothing will hurt you.’ David then climbed back into bed and fell fast asleep” (Marie F. Felt, “David: A Boy of Promise,” *Instructor*, Sept. 1969, p. 330).

Story

Tell the following story about Elder Hugh B. Brown, who became an Apostle in the Church:

“If I had a bad dream in the night when I was young, I would awaken and call out, ‘Mother, are you there?’ Since mother’s room was next to mine, she would hear me and answer quickly, ‘Yes, Son, I’m here.’

“Years later when I left for a mission to England, my mother reminded me that she wouldn’t be there to answer when I called but that our Heavenly Father would always be there.

“Many times on my mission and throughout my life I have called out: ‘Father, are you there?’ . . . Always, I have received an answer” (in Joleen Meredith, “Friend to Friend,” *Friend*, Aug. 1975, p. 7).

Explain that Heavenly Father may not talk to us out loud, but he is always watching over us. Sometimes he helps us by giving us peaceful feelings or by putting ideas into our minds.

Teacher presentation or guest speaker

Share a personal experience when you felt that Heavenly Father was watching over and protecting you, or have the invited ward or branch member share his or her experience.

Art activity

Give each child crayons or pencils and a paper circle. Have each child draw his or her face on the circle. String the yarn through the hole at the top of each circle and tie the yarn so the child can wear the circle around his or her neck. Read aloud or have the children read the words on their circles.

Summary

Testimony

Bear your testimony that just as Heavenly Father loved and watched over Jesus Christ when he was on the earth, Heavenly Father also loves and watches over each of us.

Point to a child and say, “Heavenly Father will always watch over (child’s name).” Repeat for each child.

Encourage the children to trust Heavenly Father and ask for his protecting care in their prayers tonight.

Invite a child to give the closing prayer. Ask the child to express gratitude to Heavenly Father for his love and help.

Enrichment Activities

Choose from the following activities those that will work best for the children in your class. You can use them in the lesson itself or as a review or summary. For additional guidance, see “Class Time” in “Helps for the Teacher.”

1. Prepare pieces of paper describing situations in which the children could ask for Heavenly Father’s help. Put the pieces of paper in a container and have the children take turns choosing one and telling what they would do in the situation described. You may want to use the following situations or create some of your own:
 - a. Your family is about to leave on a trip. Your parents are concerned about the safety of the family while traveling.
 - b. Your little sister is sick and in the hospital. You are worried about her.
 - c. You become lost while hiking with your family.
 - d. You have a broken leg and you are tired of the pain and the uncomfortable cast. You feel very frustrated.
 - e. This is your first day to go to Primary in a new ward or branch and you are afraid.
2. Place the chairs randomly throughout the room and tell the children that the chairs represent the problems we have in life. Blindfold one of the children and guide her or him through the room with verbal directions. Explain that although we can’t see Heavenly Father, following his commandments will help us through our lives. If the child bumps into a chair, explain that we all bump into problems and can ask Heavenly Father for comfort and help to deal with our problems. Give each child who wants to participate a turn to be blindfolded and guided through the room.
3. Sing or say the words to both verses of “God Is Watching Over All” (*Children’s Songbook*, p. 229) or “I Know My Father Lives” (*Children’s Songbook*, p. 5). The words to “I Know My Father Lives” are included at the back of the manual.

God Is Watching Over All

God has numbered in the sky
All the stars that shine on high.
Worlds so great and sparrows small;
God is watching over all.

He remembers night and day
Ev’ry child at work or play.
He will teach you what to do;
God is watching over you.

(Original title: “Loving Care.” From *Tuning Up* of THE WORLD OF MUSIC series, © 1936 by Silver Burdett & Ginn. Used by permission.)

Jesus Christ Was a Child like Me

Lesson 9

Purpose	To strengthen the children’s desire to be like Jesus Christ by increasing their knowledge of Jesus’ childhood.
----------------	--

Preparation	<ol style="list-style-type: none">1. Prayerfully study Matthew 2:19–23 and Luke 2:40–52. See also <i>Gospel Principles</i> (31110), chapter 11.2. Use paper and sticks to make a scroll as shown in picture 2-12, A Biblical School, and described in the lesson. Write on the scroll the words in Luke 2:52.3. Prepare to sing or say the words to both verses of “Jesus Once Was a Little Child” (<i>Children’s Songbook</i>, p. 55). If possible, ask the Primary music leader to help the children practice this song in singing time the week before and the week of this lesson.4. Materials needed:<ol style="list-style-type: none">a. A Bible.b. Baby items such as a bottle, blanket, and rattle.c. CTR chart (see lesson 1).d. Picture 2-10, Biblical Family Life; picture 2-11, Childhood of Jesus Christ (Gospel Art Picture Kit 206; 62124); picture 2-12, A Biblical School; picture 2-13, Boy Jesus in the Temple (Gospel Art Picture Kit 205; 62500).5. Make the necessary preparations for any enrichment activities you want to use.
--------------------	--

Suggested Lesson Development	<p>Invite a child to give the opening prayer.</p> <p>Follow up with the children if you encouraged them to do something during the week.</p> <p>Jesus Was Once a Child</p> <p>Attention activity Pass around the baby items and let the children look at and hold them. Explain what the items are used for. Point out that Jesus Christ was once a baby.</p> <ul style="list-style-type: none">• Do you think Jesus used items like these? <p>Point out that some of the things Jesus had when he was a baby were very similar to things the children used when they were babies. Some of the things were very different. Explain that in this lesson the children will learn about Jesus’ life when he was a child.</p> <p>Jesus Had a Home</p> <p>Picture discussion Display picture 2-10, Biblical Family Life. Tell the children that this is the kind of home that the people of Nazareth lived in. Nazareth is the town where Jesus grew up (see Matthew 2:23), and Jesus may have lived in a home like this one.</p>
-------------------------------------	--

Let the children study the picture, talk about it, and ask questions. If the children do not have questions, you may want to ask some like the following:

- Where do you think the family slept? (Point out the mat the woman is putting away and the closet behind her that seems to hold other rolled mats. Explain that the roofs of the houses were flat, and steps on the outside of each house led up to the roof. Perhaps the children sometimes slept on the roof.)
- Where did the baby in this home sleep? (Point out the cradle. Explain that Joseph was a carpenter and could have made a cradle like this one for the baby Jesus.)
- What do you think the big jars were used for? (Some held water. All the water the family used was carried from the well in the village because there was no running water in the homes. A well is a deep hole in the ground with clean water in it.)
- What is the woman who is sitting on the floor doing? (Grinding grain to make into bread.)
- Since there was no electricity, how could they light this home? (They used oil lamps. Point out the lamp on the stool behind the woman grinding grain. Perhaps some of the jars held oil for the lamps.)

Picture discussion Display picture 2-11, Childhood of Jesus Christ.

- Who are the people in this picture? (Jesus and Joseph.)
- What are they doing?

Explain that Jesus probably helped Joseph with his work, and Joseph may have taught Jesus to be a carpenter like himself (see Mark 6:3).

- What else do you think Jesus learned in his home?

Emphasize that in his home Jesus was told stories about the prophets, like the stories we read in the Bible. He was also taught to pray and to choose to do the right just as we are taught by our parents. Mary and Joseph believed in Heavenly Father just as we do.

Jesus Did Many Things as a Boy

Activity

Have the children hold out their hands. Mention different foods that they might eat. Tell the children to turn their palms up if they think Jesus ate that food and turn their palms down if they think he didn't eat that food. Be sure to mention any foods the children eat that Jesus may have eaten, such as bread, fish, lamb, honey, grapes, figs, dates, and milk.

Discussion

- How do you think your childhood is different from Jesus' childhood?
- How do you think your childhood is similar to Jesus' childhood?

Have the children discuss things they do that Jesus Christ may have done as a boy. For example, they may run errands, help their parents, go to school, take care of a baby, sing songs, play games, run races, or ride horses. Suggest that Jesus probably did these or similar things (for example, Jesus may never have ridden a horse, but he probably rode a donkey).

Jesus Studied the Scriptures

Picture discussion	<p>Show picture 2-12, A Biblical School. Explain that the young boys of Nazareth went to school at the synagogue, or church. The schoolteacher was head of the village synagogue. He was called a <i>rabbi</i>.</p> <p>Have the children say <i>rabbi</i> together.</p> <p>Explain that besides being taught at home, Jesus may have gone to a school like this one.</p> <ul style="list-style-type: none"> • How is this school different from your school? (Answers might include the way the boys dressed, where they sat, and the tablets they wrote on.) <p>Explain that at this time little girls did not go to school. They were taught at home by their mothers.</p>
Scroll demonstration	<p>Point out that the school does not have any books. In Jesus' time, boys learned to read from scrolls. Have the children repeat the word <i>scroll</i>.</p> <p>Show the children the scroll you have made. Explain that a scroll is a long strip of paper-like material with writing on it, fastened at each end to a stick. As one end is unrolled, the other is rolled up so a piece about the size of a page is visible. Demonstrate this with the scroll you have made. Then set the scroll aside until later in the lesson.</p>
Teacher presentation	<p>Explain that the scrolls the boys studied at school contained the teachings of the prophets who had lived before Jesus Christ was born. Show the part of the Bible that is the Old Testament. Tell the children that this part of the Bible contains some writings and stories that were on some of the scrolls.</p> <p>Have a child point out the scroll the <i>rabbi</i> in the picture is holding and the scrolls in the box at his side. Explain that the boys learned to read and write from the scrolls. This could be compared to us learning to read and write from the Bible.</p>
Scripture story	<p>Show picture 2-13, Boy Jesus in the Temple, and tell the story found in Luke 2:41–50.</p> <p>Help the children understand how worried and frightened Mary and Joseph were at the end of the first day's travel when they could not find Jesus anywhere. They hurriedly returned to Jerusalem and looked for three days before they finally found him.</p> <ul style="list-style-type: none"> • Where did Mary and Joseph find Jesus? • What was Jesus doing in the temple? (See Luke 2:46.) <p>Explain that Jesus was talking with men who had studied the scriptures a great deal. These men were surprised that Jesus knew so much. Read aloud Luke 2:47. Explain that <i>astonished</i> means surprised.</p>
Discussion	<p>We Can Become More like Jesus Christ</p> <p>Explain that Jesus returned to Nazareth with Mary and Joseph and grew up there. Pick up the scroll that you have made, and from it read Luke 2:52. Explain that <i>increased</i> means grew.</p> <ul style="list-style-type: none"> • What does this scripture mean when it says Jesus grew in wisdom?

Explain to the children that each of them is also growing in wisdom, because they are learning to choose the right. Give several examples of how they are wiser now than they were a few months ago.

- What does the last part of the verse mean when it says that Jesus increased “in favour with God”? (Heavenly Father was pleased because Jesus always did what Heavenly Father wanted him to do.)
- How can you grow in favor with Heavenly Father?

Explain that Heavenly Father is pleased when we become more like Jesus. Jesus always chose the right.

- How do you think Jesus would treat a child that others made fun of?

Have the children ask themselves, “How do I treat a child others make fun of?”

- When young Jesus was playing and his mother or Joseph asked him to do something, what do you think he did?

Have the children ask themselves, “What do I do if I am playing and my mother or father asks me to do something?”

Explain that Jesus also “grew in favour” with other people (see Luke 2:52). They liked to be around him.

- Would you have liked to have Jesus for your friend when he was a boy?

CTR chart

Display the CTR chart and have the children repeat the words on it: “I will choose the right.” Remind them that they become more like Jesus Christ when they choose the right.

Summary

Song

With the children, sing or say the words to both verses of “Jesus Once Was a Little Child.” Explain any words the children are unfamiliar with. For example, *vexed* means upset. Jesus didn’t get upset when things didn’t go his way.

Jesus once was a little child,
A little child like me;
And he was pure and meek and mild,
As a little child should be.
So, little children,
Let’s you and I
Try to be like him,
Try, try, try.

He played as little children play
The pleasant games of youth;
But he never got vexed if the game went wrong,
And he always spoke the truth.
So, little children,
Let’s you and I
Try to be like him,
Try, try, try.

Testimony

Testify that choosing the right and becoming like Jesus Christ will make us happy. Tell the children how thankful you are to have Jesus' life as an example of how we should live.

Suggest to the children that Jesus' childhood was probably in some ways much like their own. Encourage them to always choose the right, as Jesus did.

Invite a child to give the closing prayer.

Enrichment Activities

Choose from the following activities those that will work best for the children in your class. You can use them in the lesson itself or as a review or summary. For additional guidance, see "Class Time" in "Helps for the Teacher."

1. Measure the height of each child with string or yarn. Cut a piece of string or yarn to match each child's height and let the child keep it. Remind the children that as their bodies grow, they should also grow in favor with God. They can do this by making good choices, as Jesus Christ did.
2. Help the children repeat Luke 2:52 with you a few times. Discuss specific choices they can make to enable them to grow in favor with Heavenly Father.
3. Bring a food that Jesus Christ probably ate, such as figs, grapes, dates, cheese, bread, nuts, or olives, and let the children taste it. Check with the children's parents beforehand to make sure no child is allergic to the food you bring. (Do not bring food if you are teaching this lesson on fast Sunday.)
4. Discuss the things babies can do and compare them to what the children can do now. Ask questions such as the following:
 - Can a baby walk? Can you walk?
 - Can a baby talk? Can you talk?

Explain that as the children grow so does their ability to be more like the Savior by choosing the right.

5. Give each child a piece of salt dough (see recipe below) and let him or her construct a small bowl, vase, or other item that might have been used when Jesus Christ was a boy.

Salt Dough

Materials needed:

2 cups flour
 1 cup salt
 1 tablespoon oil
 water
 food coloring (optional)

Directions: Combine salt and flour. Add oil and enough water to give the mixture a claylike consistency. Add more water a little at a time until the mixture is pliable but not sticky. Knead slightly. If you wish to color dough, add food coloring to the water before adding the water to the salt and flour. Keep the dough in an airtight container.

Lesson
10

I Can Speak with Heavenly Father in Prayer

Purpose

To help the children understand that they can grow closer to Heavenly Father by praying reverently.

Preparation

1. Prayerfully study Matthew 6:9 and 3 Nephi 18:19–20. See also *Gospel Principles* (31110), chapter 8.

2. Make the following wordstrips:

You

Thee

3. Write questions such as the following on separate pieces of paper. Have at least one question for each child in your class (if your class is small you may want to have at least two questions for each child).

- a. If someone in your family had to leave home for a while, what could you ask Heavenly Father for in your prayers?
- b. If our lesson taught us to choose the right, what could we ask Heavenly Father for in our class prayer?
- c. If our lesson taught us to be kind, what could we ask Heavenly Father for in our class prayer?
- d. If your friend were sick and unable to come out and play, what might you ask in your prayers?
- e. What could we ask for in our prayers each morning and evening?
- f. What could we ask for the children in our Primary class when we pray?

4. Prepare to sing or say the words to “A Prayer Song” (*Children’s Songbook*, p. 22).

5. Materials needed:

- a. A Bible and a Book of Mormon.
- b. Picture 2-14, Class Prayer (62200); picture 2-15, Brigham Young; picture 2-16, Heber J. Grant as a Boy.

6. Make the necessary preparations for any enrichment activities you want to use.

Suggested Lesson Development**Attention activity**

Before inviting a child to give the opening prayer, display picture 2-14, Class Prayer, and reverently sing or say the words to “A Prayer Song.”

We bow our heads in prayer today,
We fold our arms together,
Then close our eyes, and while we pray
We talk to Heav’nly Father.

- While someone in the class says the prayer, what should the rest of us do?

Sing “A Prayer Song” again. Have the children get ready for the prayer by doing what the words of the song tell them to do.

Invite a child to give the opening prayer.

We Get Ready Before We Pray

Discussion

- What did the song say we do to get ready to pray?
- Why do we bow our heads when we pray?

Help the children understand that bowing our heads when we pray shows Heavenly Father that we love, honor, and respect him. Heavenly Father is greater and more powerful than a king, a president, or any person on earth, and he has done many things for us. We should show that we love and honor him.

- Why do we fold our arms when we pray?

Help the children understand that moving their hands during the prayer might keep people from listening to the prayer.

- Why do we close our eyes when we pray?

You may want to have the children close their eyes for a moment while they think of an answer.

Help the children understand that they are less likely to be distracted by things around them when they close their eyes. They can think of Heavenly Father and what they are saying to him.

We Can Feel Close to Heavenly Father When We Pray

Teacher presentation

Explain that with our heads bowed, our arms folded, and our eyes closed, we can pay attention to our prayer instead of the things around us. We can get a quiet feeling and feel close to Heavenly Father. We are ready to talk to him.

Story

Show pictures 2-15, Brigham Young, and 2-16, Heber J. Grant as a Boy, and tell in your own words the following story about a little boy who felt close to Heavenly Father during prayer:

Many years ago, Brigham Young was the prophet and President of the Church. A boy about six years old named Heber J. Grant played with one of President Young’s little boys. Often Heber would be playing in President Young’s home when it was time to call the family together for prayer. Heber would kneel down with the family, fold his arms, bow his head, close his eyes, and listen as President Young prayed. Because of the way President Young talked with Heavenly Father, it seemed to Heber that Heavenly Father was right there in the room. Sometimes Heber even opened his eyes to see if Heavenly Father was there. Of course, he saw only President Young and his family. But still he was sure that Heavenly Father was with President Young, hearing him and giving him the help and guidance he was asking for.

When Heber grew up, he became an Apostle and later President of the Church (see Heber J. Grant, *Gospel Standards*, comp. G. Homer Durham [Salt Lake City: Improvement Era, 1941], pp. 223–24.)

You may want to share a personal experience when you felt close to Heavenly Father during prayer, as Heber J. Grant did.

Remind the children that Heavenly Father is always listening to us when we pray. Bowing our heads, folding our arms, and closing our eyes while we pray can help us feel Heavenly Father near us.

We Speak Reverently When We Pray

Scripture discussion

Explain that we also show love and respect for Heavenly Father in the way we speak to him in our prayers.

- When you want to speak with someone, what is the first word you say to get their attention? (Their name.)
- When you want to talk with Heavenly Father, what is the first thing you say?

Explain that the first thing we say in a prayer is Heavenly Father's name. Tell the children that Jesus taught us to do this when he was on the earth. Read aloud Matthew 6:9, and explain that we usually shorten "Our Father which art in heaven" to "Our Father in Heaven" or "Heavenly Father."

Tell the children that Jesus also told us how to end our prayers. Read aloud 3 Nephi 18:19.

- How did Jesus tell us to end our prayers? (In his name. We end our prayers with the words *in the name of Jesus Christ, amen.*)
- When we are having a class prayer or a family prayer and the person saying the prayer says "amen," what do we do?

Explain that when we say "amen" at the end of a group prayer, it means that we agree with what the person speaking said in the prayer. We have been praying with the person who said the prayer.

Wordstrip discussion

Ask the children if they have noticed that when we talk to Heavenly Father, we don't say *you*, as in "We thank you" or "We ask you."

Display the wordstrip "You."

- What word do we use instead of *you*? (*Thee.*)

Cover the wordstrip "You" with the wordstrip "Thee." Have the children repeat reverently "We thank thee" and "We ask thee."

- Why do we say *thee* instead of *you*? (It is another way of showing Heavenly Father that we respect and honor him.)

We Pray to Thank Heavenly Father for Our Blessings

Game

Tell the children that there are two very important reasons why we pray. To help the children discover the first important reason for praying, divide them into two teams. Alternating between teams, have the children take turns naming something Heavenly Father has done for them. Each time they must name something that has not previously been mentioned. If a team cannot answer promptly, the turn goes to the other team. Play the game for a few minutes or until neither team can think of something not already mentioned.

If the children did not give the following possible answers, mention them now:

- Heavenly Father gave us our lives.
- He gave us our families.
- He gave us the earth.
- He sent Jesus Christ to the earth to help us.
- He promised to answer our prayers in the best way.

Discussion

Discuss the following questions with the children:

- When someone gives you a gift or is kind and loving to you, what should you say?
- Who has given us more gifts than anyone else? (Heavenly Father.)
- What is the first reason for praying? (To thank our Heavenly Father for the many blessings he gives us.)

Emphasize that just as we thank our parents, family members, or friends for things they do for us, we should also thank Heavenly Father for things he does for us. Heavenly Father is happy when we thank him.

We Pray to Ask for Heavenly Father's Help

Story

Tell in your own words the following story about Stephen to help the children discover the second reason we pray:

Stephen had just moved with his parents to a new town. On the first day of school he didn't know anyone in his class. Stephen began to feel terrible. He wanted to go home. He put his head down on the desk because he didn't want anyone to see him cry.

Soon the teacher noticed that Stephen had put his head down on the desk. She thought he must be sick, so she went over to talk to him. Stephen was embarrassed to be crying in school, and he tried to stop. But he felt so bad he couldn't.

Softly, so no one else could hear, he prayed, "Please, Heavenly Father, help me stop crying."

Soon Stephen was able to stop crying. He told his teacher he felt better, and he had a happy day.

Discussion

- What helped Stephen feel better?
- How have your prayers helped you?

Activity

Explain that a second reason we pray is to ask for Heavenly Father's help. To help the children understand some specific ways they can ask for help in their prayers, spread the question papers on the table or floor. Let each child select a piece of paper. Read each question and have the child who selected it give the answer.

Help the children understand that to receive Heavenly Father's help, we must try hard to choose the right. Then if we pray for help and ask for what Heavenly Father knows is best for us, he will give us what we have prayed for (see 3 Nephi 18:20).

Summary

Discussion

- What could we thank Heavenly Father for in our closing prayer today? (Answers may include the opportunity to come to Primary and learn more about prayer.)
- What could we ask Heavenly Father for in our prayer?

Testimony

Bear your testimony of how important it is to talk to Heavenly Father every day. Remind the children that we should pray in the morning, in the evening, and whenever we need special help or feel especially grateful to Heavenly Father.

Encourage the children to remember to pray in the morning and the evening every day this week.

Invite a child to give the closing prayer. Before the prayer, have the children get ready to pray by softly singing “A Prayer Song” and doing what the song tells them to do. Remind them that Heavenly Father is listening and that everyone in the room is praying even though only one person is saying the words. Remind all the children to say “amen” at the end of the prayer.

Enrichment Activities

Choose from the following activities those that will work best for the children in your class. You can use them in the lesson itself or as a review or summary. For additional guidance, see “Class Time” in “Helps for the Teacher.”

1. Give each child a copy or tracing of the handout titled “I Will Pray Reverently,” found at the end of the lesson. Give the children crayons and let them color their pictures. Encourage the children to show their pictures to their families and tell their families what they learned about prayer today.
2. Help the children sing or say the words to the first verse of “We Bow Our Heads” (*Children’s Songbook*, p. 25), doing the actions indicated:

We bow our heads (*bow heads*) and close our eyes (*close eyes*)
And say a little prayer (*fold arms*).
We thank our Father graciously
For blessings we all share (*outstretch arms*).
3. Sing or say the words to the second verse of “I Pray in Faith” (*Children’s Songbook*, p. 14) to remind the children of the things they should say when they pray.

I begin by saying “Dear Heavenly Father”;
I thank him for blessings he sends;
Then humbly I ask him for things that I need,
In the name of Jesus Christ, Amen.
(© 1987 by Janice Kapp Perry. Used by permission.)
4. Give the children paper and crayons or pencils, and let them draw pictures of themselves praying. They could draw pictures of family prayer, morning or evening personal prayer, prayer at mealtime, or any other place and time when they pray.

I Will Pray Reverently



I Can Tell Others about Jesus Christ

Purpose	To inspire each child to help others learn about Jesus Christ.
----------------	--

Preparation	<ol style="list-style-type: none"> 1. Prayerfully study Alma 17–19, 23. 2. Prepare to sing or say the words to “I Hope They Call Me on a Mission” (<i>Children’s Songbook</i>, p. 169). 3. Materials needed: <ol style="list-style-type: none"> a. A Book of Mormon. b. CTR chart (see lesson 1). c. Picture 2-17, Four Sons of Mosiah Kneeling in Prayer; picture 2-18, Ammon Teaching King Lamoni. 4. Make the necessary preparations for any enrichment activities you want to use.
--------------------	--

Suggested Lesson Development	<p>Invite a child to give the opening prayer.</p> <p>Follow up with the children if you encouraged them to do something during the week.</p>
Review	<p>Comment on the reverence of the children and on the language used in the prayer. Give a quick review of the previous lesson to emphasize the importance of prayer.</p>
	Missionaries Tell Others about Jesus Christ
Attention activity	<p>Sing or say the words to “I Hope They Call Me on a Mission” with the children.</p> <p>I hope they call me on a mission When I have grown a foot or two. I hope by then I will be ready To teach and preach and work as missionaries do.</p> <p>I hope that I can share the gospel With those who want to know the truth. I want to be a missionary And serve and help the Lord while I am in my youth.</p> <ul style="list-style-type: none"> • Do you know any missionaries? <p>Let the children talk about missionaries they know, such as family members serving missions or the missionaries in your area.</p> <ul style="list-style-type: none"> • What do missionaries do? <p>Explain that in this lesson the children will learn about ways they can be missionaries while they are young.</p>

Scripture story Show the children the Book of Mormon and tell the story of the sons of Mosiah, as found in Alma 17:6–12. Explain that any of King Mosiah’s sons could have been the next king, but they all wanted to be missionaries instead. They wanted to teach the Lamanites, who were very wicked at this time. The sons of Mosiah wanted every person to have an opportunity to hear the gospel. Explain that because the Lamanites were so wicked, it was dangerous for the sons of Mosiah to go teach them.

- How do you think the sons of Mosiah prepared themselves before they went to teach the Lamanites?

Show picture 2-17, Four Sons of Mosiah Kneeling in Prayer.

Explain that the sons of Mosiah prayed and asked Heavenly Father to help them be good missionaries. Heavenly Father told them that he would watch over them and they would be able to teach many people (see Alma 17:10–11). Read aloud Alma 17:12. Point out that praying helped give the sons of Mosiah courage to go teach the Lamanites.

Scripture story Explain that the sons of Mosiah all went to different areas to teach. Show picture 2-18, Ammon Teaching King Lamoni, and tell the story found in Alma 17:17–25. Explain that Ammon, one of the sons of Mosiah, volunteered to be a servant to the Lamanite king, King Lamoni. Ammon was assigned to tend the king’s sheep. Ammon was the best servant King Lamoni had. Ammon set such a good example that King Lamoni and his people wanted to learn about the gospel.

Explain that because of the work of Ammon and his brothers, thousands of the Lamanites joined the Church (see Alma 23:5).

- Discussion
- Why did Ammon and his brothers risk their lives to teach the gospel to the Lamanites? (The gospel had brought them happiness, and they wanted to share it with other people.)
 - What did Ammon do that helped him teach the Lamanites the gospel? (He prayed for help; he worked hard; he was a good example.)

We Can Be Missionaries

Explain that one way we can be missionaries is by telling others about Jesus Christ. It is important that everyone learn about Jesus and his church.

Story Tell a story about a child who helped others learn about Jesus Christ and his church. You may want to use the following story:

Thad sometimes had a hard time listening in stake conference because it seemed to him that most of the talks were for grown-ups. But when Thad heard the stake president say, “Children, you can be missionaries too,” Thad listened, and he started thinking of ways he could be a missionary and tell others about Jesus.

The next morning at breakfast, Thad talked with his parents about inviting Mrs. Murphy, their next-door neighbor, to learn about the Church. Thad’s parents thought it was a good idea, so Thad went over to Mrs. Murphy’s house and asked her if she would like to learn about Jesus and his church. Mrs. Murphy said she would, and soon she was learning from the missionaries.

- What would have happened if Thad hadn’t asked Mrs. Murphy if she wanted to learn about Jesus and his church?

Thad's mother and father began to follow Thad's example. They talked about the Church with their friends and other people they met. Some people didn't want to hear about the Church, but some did, and some were baptized. When Mrs. Murphy was baptized, she thanked Thad for helping her learn more about the Savior.

Discussion

Using Thad as an example, point out that children can be missionaries and tell others about Jesus Christ and his church.

- Who could you tell about Jesus?

Help the children think of people they could tell about Jesus, such as friends, neighbors, and relatives who are not members of the Church or who do not attend church.

Explain that each of us can also be a missionary by being a good example, by being kind and thoughtful to others, and by living the gospel. Remind the children that one of the ways Ammon was a good missionary was by setting a good example.

Story

In your own words, tell the following story about children who were missionaries:

One day two missionaries knocked on the door of a home. A woman named Mrs. James opened the door. The missionaries told her they were from The Church of Jesus Christ of Latter-day Saints. Mrs. James invited the missionaries in and told them she would like to learn more about the Church. This made the missionaries very happy.

Mrs. James told the missionaries that she used to live next door to a family that belonged to the Church. She said the children in that family were always very polite and kind. They played fairly with everyone and treated other people's property with respect. Mrs. James said she would like to learn about a church that taught those children to be such nice neighbors.

- How were the children who lived next to Mrs. James missionaries?
- How could you be a good example to your neighbors and friends?

Dramatization activity

Explain to the children that they are going to act out several situations in which they could be missionaries by being kind and thoughtful.

Have the children listen to a situation, and then select children to act out what they would do in that situation. Give each child a chance to participate in at least one situation. Use the following examples or create your own:

Situation 1 (three children needed)

Two of you are walking down the street. You see a small child starting to climb a very big tree. You know it is dangerous for the child to do this.

- What would you do?

Situation 2 (two children needed)

You see a neighbor with an armload of groceries. One of the grocery sacks breaks, and oranges roll all over the ground.

- What would you do?

Situation 3 (three or more children needed)

You are playing with your friends. A child who has just moved in nearby wants to join you.

- What would you do?

Situation 4 (four or more children needed)

A new family moves into your neighborhood. They are not members of the Church. You think the children might enjoy coming to the Primary activity next week.

- What would you do?

After the dramatization activity, thank the children for being good missionaries.

Summary

CTR chart

Point to the CTR chart or have the children look at their CTR rings. Tell the children that by being missionaries they are choosing the right and following Jesus Christ. Have the children repeat the words on the chart (or tell what the initials on their rings stand for).

Testimony

Compliment the children for wanting to be good missionaries. Bear testimony about the importance of teaching every person about Jesus Christ and his church. Learning about Jesus and his church makes us happy.

Help each child think of one way he or she can be a missionary in the coming week. These ideas do not have to be complicated or extensive. Remind the children that they can be missionaries by being friendly and helping others as well as by inviting people to learn about the Church.

Encourage the children to talk with their families about ways to be a missionary. Invite a child to give the closing prayer.

Enrichment Activities

Choose from the following activities those that will work best for the children in your class. You can use them in the lesson itself or as a review or summary. For additional guidance, see “Class Time” in “Helps for the Teacher.”

1. With the approval of your Primary president, invite the missionaries serving in your area or a recently returned missionary to attend the last few minutes of class and talk to the children about what they can do to be missionaries now.
2. Tell the children about a time when missionaries helped you or when you were able to help someone else learn about Jesus Christ and his church. Tell them how this experience made you feel.
3. Have the children draw pictures of themselves as missionaries. Label each picture the following way:

(Child's Name)
Missionary
The Church of Jesus Christ
of Latter-day Saints

4. Sing or say the words to the first verse of “I Want to Be a Missionary Now” (*Children’s Songbook*, p. 168), “The Things I Do” (*Children’s Songbook*, p. 170), or “We’ll Bring the World His Truth” (*Children’s Songbook*, p. 172).

I Want to Be a Missionary Now

I want to be a missionary now.
I don’t want to wait until I’m grown.
I want to share the gospel while I’m young,
For I have a testimony of my own.

The Things I Do

I’m much too young to go abroad
To teach and preach the word of God,
But I can show I know it’s true,
Quite simply, by the things I do.

We’ll Bring the World His Truth

We have been born, as Nephi of old,
To goodly parents who love the Lord.
We have been taught, and we understand,
That we must do as the Lord commands.

Chorus:

We are as the army of Helaman.
We have been taught in our youth.
And we will be the Lord’s missionaries
To bring the world his truth.

(© 1983 by Janice Kapp Perry. Used by permission.)

I Can Prepare for Baptism

Lesson
12

Purpose

To increase each child's desire to be baptized and to give the children an understanding of how to prepare for baptism.

Preparation

1. Prayerfully study Matthew 3:13–17 and Doctrine and Covenants 20:72–74. See also John 1:25–34 and *Gospel Principles* (31110), chapter 20.
2. If possible, ask the Primary music leader to have the children sing “Baptism” (*Children's Songbook*, p. 100) during opening or closing exercises.
3. Obtain a heavy piece of paper large enough to cover picture 2-19, John the Baptist Baptizing Jesus. Cut the paper into as many smaller pieces as there are children in your class. Place the pieces over the picture so it cannot be seen.
4. Make six large footprints out of heavy paper.
5. Make a copy or tracing of the page of drawings at the end of the lesson for each child.
6. Prepare to give a few details about your own baptism, such as who baptized you and where you were baptized, and talk briefly about your feelings about being baptized. If you were baptized as a child, you may want to bring a picture of yourself at that age.
7. Materials needed:
 - a. A Bible.
 - b. Tape or other adhesive.
 - c. Picture 2-19, John the Baptist Baptizing Jesus (Gospel Art Picture Kit 208; 62133); picture 2-20, Boy Being Baptized (62018).
8. Make the necessary preparations for any enrichment activities you want to use.

Note to teachers of older children: Enrichment activities 5, 6, and 7 are designed especially for older children who will soon be baptized.

Suggested**Lesson****Development**

Invite a child to give the opening prayer.

Follow up with the children if you encouraged them to do something during the week.

Jesus Christ Was Baptized

Attention activity

Display the covered picture of John the Baptist baptizing Jesus. Tell the children that the picture underneath the paper is of two important people. Ask the children to try to guess who the people are, but tell them not to say anything out loud until the whole picture can be seen. Ask each child to remove a piece of paper from the covered picture, one at a time.

When all the pieces have been removed, ask:

- Who are the people in the picture?
- What are they doing?

Scripture story

Tell the story of Jesus Christ's baptism, as found in Matthew 3:13–17. Explain that John the Baptist was surprised when Jesus asked to be baptized. John knew that Jesus had never sinned, so he didn't think Jesus would need to be baptized. But Jesus told John that being baptized was a commandment from Heavenly Father, and he wanted to obey all of Heavenly Father's commandments.

Point out the river in the picture and explain that John baptized Jesus in the Jordan River. John baptized Jesus by immersion. *Immersion* means being completely covered by water.

Read aloud Matthew 3:17 and explain that these are Heavenly Father's words. Tell the children that Heavenly Father is also pleased when we are baptized.

Game

Play the "Last Words" game with the children. Read the statements below, leaving out the underlined words. Ask a child to fill in the appropriate words. If a child does not remember the answer, go to the next child until the right answer is given (do not embarrass a child who cannot answer a question). Continue until each child has answered a question correctly, helping the children as needed. Use questions twice if necessary.

1. Jesus Christ was baptized by John the Baptist.
2. Jesus was baptized in the river Jordan.
3. Jesus was baptized to obey Heavenly Father's commandment (teaching).
4. When Jesus was baptized, he was completely covered by water.
5. After Jesus was baptized, he and John heard the voice of Heavenly Father.
6. When we are eight years old, we can follow the example of Jesus and be baptized.

We Can Follow Jesus Christ's Example by Being Baptized

Teacher presentation

Tell the children that when they are eight years old, they can be baptized. Right now, they should be getting ready for when they turn eight years old and can be baptized.

Explain that when we are baptized we make covenants (promises) with Heavenly Father. We promise to obey his commandments, forgive others, and follow Jesus Christ. In return, he accepts us into the Church and promises to guide and help us.

Tell the class about your baptism. You may want to mention where you were baptized (such as a font or river), who baptized you, and who was there to see you be baptized. If you were baptized as a child, show the children a picture of yourself at that age. Share with them the feelings you had about being baptized, such as excitement or a desire to be a member of the Church.

Tell the children that someday they can also be baptized as Jesus Christ was and as you were.

Story

Tell a story about a child being baptized. You may want to use the following story:

Marco's family joined the Church when he was seven years old. Everyone in the family was baptized except Marco. He was not old enough yet. Marco was very disappointed that he could not be baptized with his family, but his mother told him that soon he would be old enough to be baptized, and he should use the time while he was waiting to prepare.

- How could Marco prepare to be baptized?

During the next year Marco tried hard to choose the right and do what Jesus would want him to do. Finally Marco turned eight years old. He dressed all in white, and his father baptized him. As Marco's father brought him out of the water, Marco was very glad he could be baptized by immersion, as Jesus was. He was happy to be a member of Jesus' church.

We Can Prepare Now for Baptism

Footprint activity

Show picture 2-20, Boy Being Baptized, and, if possible, attach the picture to the classroom door.

- How is this child following Jesus' example?

Remind the children that right now they can prepare for baptism. Show the paper footprints and one copy of the six drawings from the end of the lesson. Tell the children that the drawings represent steps that will lead them to baptism. Discuss each step illustrated, asking questions such as those listed below. After you discuss each step, have a child place a footprint on the floor, forming a path to the baptism picture.

1. Believe in and learn about Jesus Christ and Heavenly Father.
 - Why should we learn about Jesus Christ and Heavenly Father?
 - Where can we learn about them?
2. Pray to Heavenly Father.
 - How can praying help us be ready for baptism?
3. Be forgiving and love others.
 - What happens when we forgive?
 - How can we show our love for others?
4. Choose the right every day.
 - What are some ways we can choose the right?
5. Read or listen to scripture stories.
 - How has studying the scriptures helped you?
6. Be eight years old.
 - What can you do before you are eight years old to prepare for baptism?

After all the footprints have been placed on the floor, let the children, one at a time, cross the room to the baptism picture by stepping on the footprints. Help the children explain, as they step on each footprint, how they can prepare for baptism.

Summary

Handout	Give each child a copy of the set of six drawings to take home. Print or have the children print their names on their papers.
Testimony	<p>Bear testimony to the children of the importance of baptism. Remind the children that Heavenly Father is pleased when we are baptized.</p> <p>Suggest that the children use the page of drawings to teach their families what they learned about baptism. Encourage each child to prepare to be baptized by following the six steps illustrated by the drawings.</p> <p>Invite a child to give the closing prayer.</p> <p>When the children are ready to leave class, have them walk on the footprints again on their way out of the room.</p>

Enrichment Activities

Choose from the following activities those that will work best for the children in your class. You can use them in the lesson itself or as a review or summary. For additional guidance, see “Class Time” in “Helps for the Teacher.”

1. Draw a footprint on a piece of paper for each child. Write *I will follow Jesus Christ* on each footprint. Let the children color or decorate the footprints.
2. If there is a baptismal font in the building where you meet, arrange to take the children to see it.
3. Sing or say the words to the first two verses of “I Like My Birthdays” (*Children’s Songbook*, p. 104). The words to this song are included at the back of the manual.
4. Sing or say the words to “Baptism” (*Children’s Songbook*, p. 100) or “When Jesus Christ Was Baptized” (*Children’s Songbook*, p. 102). The words to “Baptism” are included at the back of the manual.

When Jesus Christ Was Baptized

When Jesus Christ was baptized
Down in the River Jordan,
Three members of the Godhead
Were present there in love.
The Father spoke from heaven
When Jesus Christ was baptized;
The Holy Ghost descended
As gently as a dove.

And now when I am baptized,
I’ll follow his example—
Be baptized by immersion
Through sacred priesthood pow’r.
Then I will be a member
Of Heav’nly Father’s kingdom
And have the Holy Spirit
To guide me ev’ry hour.

5. Display picture 2-20, Boy Being Baptized, next to picture 2-19, John the Baptist Baptizing Jesus. Review with the children what they know about being baptized. Help them understand that baptism is a special experience to look forward to. It is one of the most important things they will ever do. Discuss the following points:
 - a. When we are baptized, we become members of The Church of Jesus Christ of Latter-day Saints. (If younger children are concerned that they are not members of the Church, assure them that children under eight can be considered members. Once they are eight years old, however, they must be baptized to be official members of the Church.)
 - b. We must be at least eight years old to be baptized.
 - c. The bishop or branch president meets with us to talk about our baptism.
 - d. We wear white clothing when we are baptized (refer to picture 2-20).
 - e. We are baptized by immersion, being completely covered by water. (Be sure that the children understand that they are under water for only a second or two, that the water is not very deep, and that the person baptizing them holds them securely.)
 - f. The person baptizing us must be a priest or hold the Melchizedek Priesthood.
 - g. We are baptized the same way Jesus Christ was baptized. He set the example for us.
6. With the approval of your Primary president, invite a priesthood holder to talk with the children about what will happen when they are baptized. Have him explain how the child and the person performing the baptism will stand and how they will hold their arms. Have him explain that the person performing the baptism will gently put the child under the water and quickly bring him or her up again. Remind the children that when they are baptized this way, they will have been baptized as Jesus was.

With the approval of your bishop or branch president, the priesthood holder can demonstrate in the classroom how a baptism is performed. (The priesthood holder should *not* say the baptismal prayer during a demonstration.)
7. Explain that the baptismal prayer is one of the few prayers that must be said exactly the same way every time. Jesus Christ revealed the words of this prayer in the scriptures. Read aloud the prayer in Doctrine and Covenants 20:73 (from *Having been commissioned*).

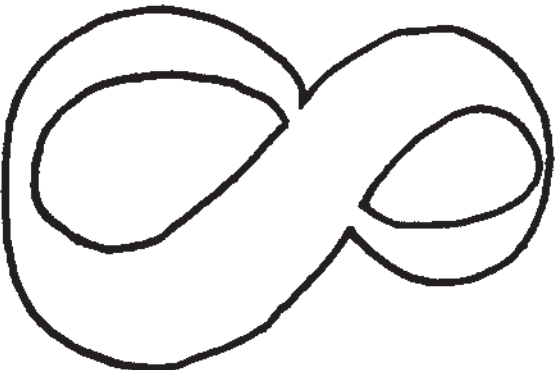
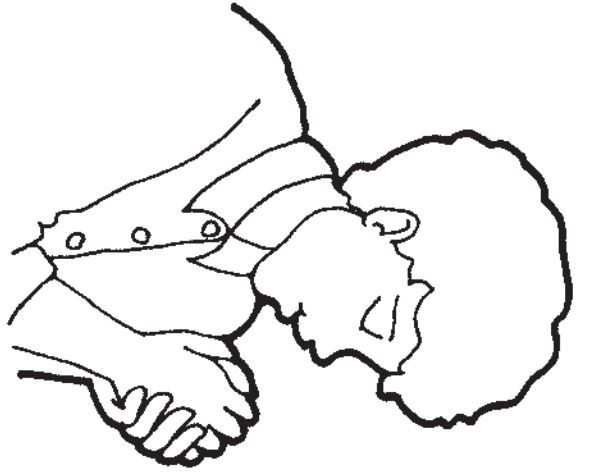
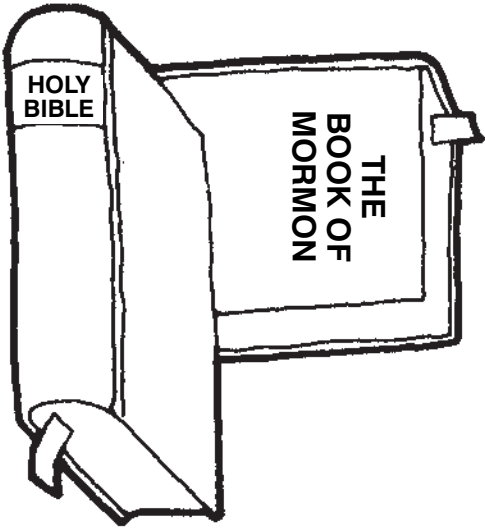
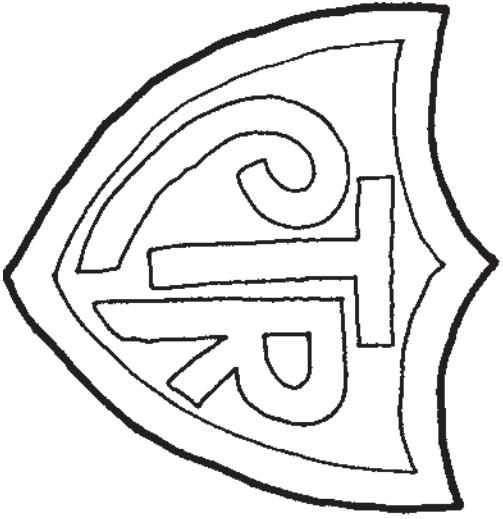

The Gift of the Holy Ghost Can Help Me

Lesson 13

Purpose To help the children understand that after they are baptized they will receive the gift of the Holy Ghost to help them.

Preparation

1. Prayerfully study Doctrine and Covenants 49:13–14, 130:22, and Articles of Faith 1:1, 4. See also Moroni 10:5; Doctrine and Covenants 9:8–9; 85:6; and *Gospel Principles* (31110), chapter 21.
2. Prepare the following “question flowers” out of heavy paper:

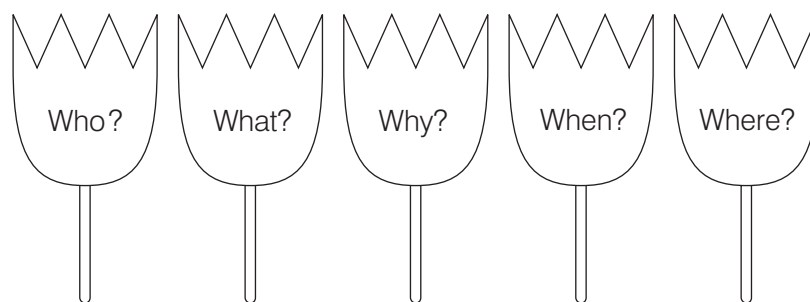

Attach the flowers to small sticks about four to six inches long and put them in a vase or jar.

3. Prepare to sing or say the words to “I Know My Father Lives” (*Children’s Songbook*, p. 5). The words to this song are included at the back of the manual.
 4. Materials needed:
 - a. A copy of the Doctrine and Covenants.
 - b. Picture 2-19, John the Baptist Baptizing Jesus (Gospel Art Picture Kit 208; 62133).
 5. Make the necessary preparations for any enrichment activities you want to use.
-

**Suggested
Lesson
Development**

Invite a child to give the opening prayer.

Follow up with the children if you encouraged them to do something during the week.

We Can Receive the Gift of the Holy Ghost

Attention activity

Display picture 2-19, John the Baptist Baptizing Jesus. Review last week’s lesson by having each child choose a question flower. Ask a question about Jesus Christ’s baptism that starts with the word on the flower. If the child who chose the flower cannot answer the question, let the rest of the class help (be careful not to embarrass a child who doesn’t know an answer).

Possible questions:

- *Who* baptized Jesus Christ? (John the Baptist.)
- *Where* was Jesus baptized? (In the river Jordan.)
- *What* is immersion? (Being completely covered by water.)
- *Why* was Jesus baptized? (To obey Heavenly Father's commandment and to set an example for us.)
- *When* can we be baptized? (When we are eight years old.)

Teacher presentation

Have the children tell you who the two people in picture 2-19 are.

- Whose voice did Jesus Christ and John the Baptist hear after Jesus was baptized?

Remind the children that Heavenly Father was watching Jesus' baptism and was pleased that Jesus was baptized. Tell the children that there was another special person at Jesus' baptism. This person helps Heavenly Father and Jesus. He is called the Holy Ghost or the Holy Spirit.

Article of faith

Have the children stand and repeat with you the first article of faith.

Scripture

Explain that the Holy Ghost is like Heavenly Father and Jesus Christ because he loves us and wants to help us. But the Holy Ghost does not have a body of flesh and bones like Heavenly Father and Jesus do. Read aloud Doctrine and Covenants 130:22, through *personage of Spirit*. Explain that we cannot see the Holy Ghost, but he can help us do what is right. He gives us a warm, happy feeling inside when we choose the right.

Scripture

Tell the children that after they are baptized, men who hold the Melchizedek Priesthood will give them two great blessings. Read aloud Doctrine and Covenants 49:14 and tell the children that this scripture tells us what one of these blessings is. Explain that *whoso doeth this* refers to any person who is baptized.

Article of faith

Help the children memorize part of the fourth article of faith: "We believe . . . [in the] laying on of hands for the gift of the Holy Ghost." Tell the children that the gift of the Holy Ghost is one of the great blessings we can receive after baptism.

Teacher presentation

Explain that when we have the gift of the Holy Ghost, the Holy Ghost will help us know what things are true and right. The Holy Ghost can help us even before we are baptized and confirmed, but after we receive this gift we may have the Holy Ghost as a constant companion. This means that as long as we try to do what is right, his influence can be with us always.

We Can Be Confirmed Members of the Church

Teacher presentation

Explain that the other blessing we receive after baptism is being confirmed a member of The Church of Jesus Christ of Latter-day Saints. This is called confirmation. Have the children say *confirmation* a few times.

Picture story

Tell the story of "Roberta's Confirmation," found at the end of the lesson. Have the children gather around you so they can see the pictures as you tell the story.

- Discussion After you tell the story, ask the following questions:
- What was Roberta given? (The gift of the Holy Ghost.)
 - Who said the prayer to give it to her? (Her father.)
 - What authority does Roberta's father have? (The Melchizedek Priesthood.)
 - What do you think Roberta's warm feeling was? (The influence of the Holy Ghost.)
- Let the children retell the story. Invite a different child to tell about each picture.

The Holy Ghost Will Help Us Know What Is True

Teacher presentation

Explain that the Holy Ghost can help us know that the Church is true. Sometimes we are so happy and grateful we want to tell others how we feel. This often happens when we bear our testimonies in fast and testimony meeting.

- Have you ever borne your testimony in fast and testimony meeting?

If any of the children have borne their testimonies, let them tell how they felt.

Explain that when some people are filled with the Holy Ghost they even cry a little. These are not sad tears; they are happy tears. Tell the children that sometimes they may get a warm, peaceful feeling during testimony meeting or as they pray, read the scriptures, or listen in church. This peaceful feeling is the whispering of the Holy Ghost letting them know that these things are true and right.

Song

With the children, sing or say the words to "I Know My Father Lives."

Explain that the "Spirit" referred to in this song is the Holy Ghost. The Holy Ghost helps us know that Heavenly Father is real and that he loves us.

The Holy Ghost Can Guide and Warn Us

Story and discussion

In your own words, tell the story of Sara Jane Jenne Cannon. Ask the children to listen for what the Holy Ghost whispered to her.

Sara Jane was a pioneer girl who walked across the wilderness in America long ago to find a new home. After she arrived in Utah, she lived with her aunt in an unfinished house. Stretched across the top of the walls was a canvas roof held in place by a large rock at each corner.

Sara Jane was at home sewing one day when she heard a voice say, "Move away quickly." There was no other person around, but Sara Jane moved to the other side of the room. Just after she moved, one of the rocks holding down the roof fell into the room. If Sara Jane had not moved, the rock would have hit her. (See "Move Away Quickly," in *Remarkable Stories from the Lives of Latter-day Saint Women*, comp. Leon R. Hartshorn, 2 vols. [Salt Lake City: Deseret Book Co., 1973–75], 2:34.)

- Who spoke to Sara Jane?
- What did the Holy Ghost say to her?
- What did Sara Jane do?
- What would have happened if Sara Jane had not listened?

Remind the children that the Holy Ghost does not always speak in a voice we can hear. Many times he gives us feelings about what we should do.

Summary

Review activity

Ask the children to tell what they know about the Holy Ghost. You may want to use the question flowers again as a review. You can use questions such as these:

- *What* valuable gift can you receive after you are baptized? (The gift of the Holy Ghost.)
- *Who* is the Holy Ghost? (A being who helps Jesus and Heavenly Father; a spirit; someone who can comfort and help us.)
- *When* are we given the gift of the Holy Ghost? (After we are baptized; when we are confirmed members of the Church.)
- *Where* can we feel the promptings of the Holy Ghost? (In our hearts and minds. Answers such as “at home,” “at church,” or “wherever we are when we choose the right” are also acceptable.)
- *Why* did Heavenly Father send the Holy Ghost to be with us? (To help and comfort us; to guide and warn us; to tell us what is true; to give us feelings of love and peace.)

Testimony

Share with the children your feelings about the Holy Ghost and how he helps and guides us. You may want to relate a personal experience when the Holy Ghost bore witness to you or helped you.

Encourage the children to choose the right so they can always have the Holy Ghost with them.

Invite a child to give the closing prayer.

Enrichment Activities

Choose from the following activities those that will work best for the children in your class. You can use them in the lesson itself or as a review or summary. For additional guidance, see “Class Time” in “Helps for the Teacher.”

1. Bring something that you received as a gift but that is no longer useful because it is broken, worn out, or used up, such as a cracked dish, an old article of clothing, or an empty food box.

Show the children the gift that is no longer useful. Tell them any interesting information about the gift, such as who gave it to you and when or why they gave it to you. Help the children understand that even though this gift was once important to you, it is no longer useful because it is broken, worn out, or used up.

Explain that when you were baptized and confirmed, you received a different kind of gift. This is a very valuable gift, one that cannot wear out or be used up. This priceless gift becomes more valuable as it is used.

- What is this gift?

When the children have guessed (or you have told them) that this gift is the gift of the Holy Ghost, tell them that they will receive many gifts throughout their lives, but the gift of the Holy Ghost is the most valuable gift they will receive while they are here on the earth.

2. Sing or say the words to “The Still Small Voice” (*Children’s Songbook*, p. 106).

Through a still small voice, the Spirit speaks to me
 To guide me, to save me from the evil I may see.
 If I try to do what’s right, he will lead me through the night,
 Direct me, protect me, and give my soul his light.

Use the actions indicated below as you sing or say the last part of the song:

Listen, listen (*cup hand to ear*).
 The Holy Ghost will whisper (*place index finger to lips*).
 Listen, listen (*cup hand to ear*)
 To the still small voice (*hand over heart*).

3. Play the following quiet game with the children to show that they may be guided by a still, small voice:

Show the children a small item you will hide for this game. Have one child leave the group for a moment while you hide the item. When the child returns, explain that he or she must listen carefully to find the object. Use a quiet noise, such as lightly tapping a pencil, gently clapping your hands, or humming a song, to show the child which way to turn to look for the hidden object. Gently tap when the child looks in the correct direction. Tap more quickly (or hum louder) as the child moves closer to the hiding place, until the item is found. Repeat the activity, giving another child an opportunity to look for the object, as often as desired.

Explain to the children that they may be guided in their lives by listening to the still, small voice of the Holy Ghost. Remind them that the Holy Ghost does not always speak out loud. Sometimes he gives us ideas or feelings, such as a warm feeling when we do something right or a bad feeling when we do (or want to do) something wrong. We must pay careful attention to know what the Holy Ghost is telling us to do.

4. Help the children trace each of their hands on a piece of paper with different colors of crayon. Have the hands overlap, representing the laying on of hands to receive the gift of the Holy Ghost. Label each picture with the child’s name.
5. Sing or say the words to “The Holy Ghost” (*Children’s Songbook*, p. 105) or the third verse of “I Like My Birthdays” (*Children’s Songbook*, p. 104). The words to these songs are included at the back of the manual.

Roberta's Confirmation



This is a special day for Roberta. She has just been baptized. Now she will be confirmed a member of The Church of Jesus Christ of Latter-day Saints, and she will be given the gift of the Holy Ghost. (You may want to explain to the children that while Roberta is baptized and confirmed by her father, any worthy Melchizedek Priesthood holder may perform these ordinances.)



After Roberta's father helps her out of the water, her mother meets her with dry clothing. Her wet hair is soon combed neatly, and she is smiling and happy!



When Roberta is ready, she returns to her family and friends, who have been waiting. She goes to a chair at the front of the room with her father.

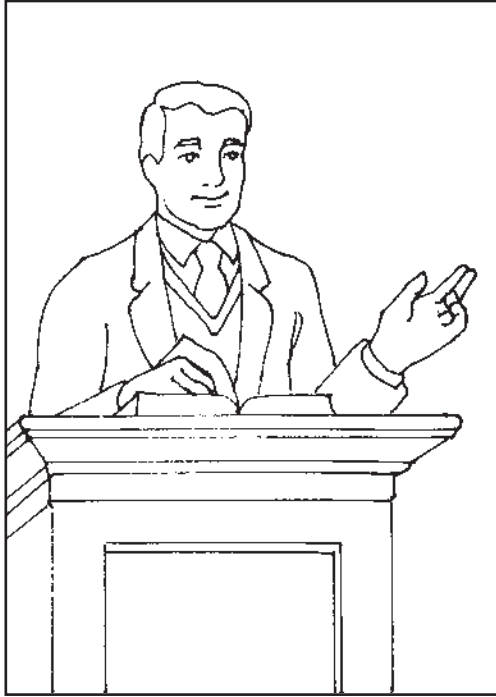

The bishop [branch president] asks the men that Roberta has chosen to come and stand in the circle. Roberta has asked her father, her grandfather, her uncle, and her home teachers. All these men hold the Melchizedek Priesthood.



Roberta bows her head and closes her eyes. The men place their hands upon her head while her father calls her by name, confirms her a member of the Church, and gives her the gift of the Holy Ghost.

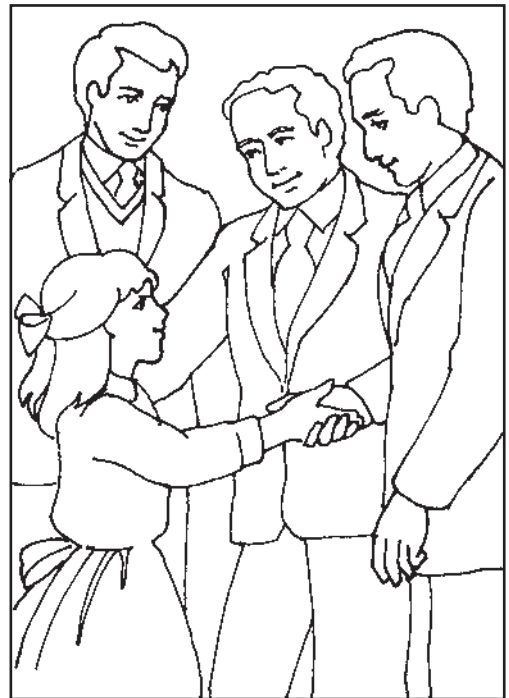

After the confirmation is finished, Roberta shakes hands with the men in the circle, and they congratulate her. Roberta has a wonderful warm feeling inside, and she knows she has chosen the right.

Lesson
14

Dare to Choose the Right

Purpose

To help the children understand that they can choose the right as Jesus Christ did when Satan tried to tempt him.

Preparation

1. Prayerfully study Matthew 4:1–11.
2. Make a simple crown out of construction paper or similar material, as shown:

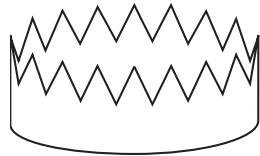

3. Trace or copy a “Choose the Right” game board (shown at the end of the lesson) onto stiff paper or cardboard.
 4. Write the questions for the game (pages 71–72) on separate pieces of paper, and put them in a small sack or other container.
 5. Prepare to sing or say the words to the first verse of “Dare to Do Right” (*Children’s Songbook*, p. 158). The words to this song are included at the back of the manual.
 6. Optional: Copy Elder Pinegar’s letter and put it in an envelope.
 7. Materials needed:
 - a. A Bible.
 - b. A few stones.
 - c. Two buttons or other small objects of different shapes or colors to be used as markers in the “Choose the Right” review game.
 - d. CTR chart (see lesson 1).
 - e. Picture 2-21, Elder Rex D. Pinegar; picture 2-22, Temple Used Anciently (Gospel Art Picture Kit 118; 62300).
 8. Make the necessary preparations for any enrichment activities you want to use.
-

**Suggested
Lesson
Development**

Invite a child to give the opening prayer.

Follow up with the children if you encouraged them to do something during the week.

We Can Make Choices for Ourselves

Attention activity

Show the “Choose the Right” game board and ask the children to listen closely to the lesson so they will be able to answer the questions that go with the game.

Discussion

- Has anyone ever dared you to do something?

Let the children tell about times when someone dared them to do something.

Letter

Tell the children that you have a letter for them from Elder Rex D. Pinegar, a General Authority of the Church. Explain that he tells about an experience he had with a dare when he was seven years old. Show picture 2-21, Elder Rex D. Pinegar, and read or tell about the letter. (If you made a copy of the letter and put it in an envelope, read from that letter instead of from the manual.)

“My dear friends,

“‘I dare you!’ are words boys and girls often hear from friends who want you to prove to them that you are brave or strong or daring. They may ask you to do something that your parents or teachers have told you not to do—something that you know is wrong to do. I have learned that when we do something we know is wrong, we show weakness rather than strength. A person shows true bravery and strength only when he has the courage to do right.

“Once, when I was about seven years old, I had a pal whom I liked very much. We often walked home from school together. . . . We talked of being brave and of being able to do many things.

“Sometimes we would dare each other to jump across a ditch or to climb a tree just to prove that we were brave or that we could do things we had seen older boys and girls do.

“As we came to my home one day we stood out by the road and talked about who was the fastest runner in the school. . . . When I strongly insisted that I could run faster than my friend, he turned to me and said, ‘If you’re so fast, I dare you to run across the road before that car gets here!’

“I looked up the road and saw a car a short distance away. Without another word I dashed into the road to prove that I was fast and brave. A moment later the car’s brakes squealed! Its bumper hit me, and I landed in an unconscious heap.

“When I opened my eyes, my aching body, a hurt pride, and my mother’s anxious face made me realize that I had been neither fast nor brave. I had only been foolish. I had brought sadness to myself and to others. . . .

“The lesson I learned . . . has been valuable to me throughout my life. I learned that the only dare a person should ever accept is the DARE TO DO RIGHT.

“If you accept a dare to do something that is not right, something that Heavenly Father or your parents would not want you to do, you will be left with a sad and disappointed feeling. When you dare to do right you will have a good feeling about yourself.

“As one friend to another I encourage you to be obedient to your parents and to the teachings of the Lord. . . . By daring to do right you will become a friend of Jesus Christ and you will enjoy His greatest blessings.

“May you always DARE TO DO RIGHT.

“With love, your friend, Rex D. Pinegar” (“Friend to Friend,” *Friend*, Oct. 1974, pp. 10–11).

Discussion

- What choice did young Rex Pinegar make? (He chose to run in front of the car.)
- Did he choose the right?
- What should he have done?

- What do you think he learned from this accident?
- When someone dares you to do something, do you have to do it?

Remind the children that Elder Pinegar told them to “dare to do right.”

- What does it mean to dare to do right?

Explain that it is not always easy to choose the right, especially when someone dares us to do something wrong. We all want our friends to think we are strong and brave, and we do not want them to call us names. Explain that daring to do right means doing the right thing even when it is difficult.

Song

Have the children stand and sing or say the words to the first verse of “Dare to Do Right.” If the children are not familiar with the song, sing or say it to them a few times to help them learn the words. Suggest to the children that the next time someone dares them to do something foolish, they can think of the words to this song. The words to the song will remind them to choose the right and will help them have the courage to do so.

CTR ring

Ask the children to look at their CTR rings if they are wearing them. Point out that their rings can also help them remember to choose the right.

Teacher presentation

Tell the children that a dare to do something wrong is called a temptation. Have the children repeat the word *temptation* a few times. Explain that Satan tries to tempt people to make wrong choices. Heavenly Father and Jesus Christ want everyone to make right choices because they know the only way to be happy is to always try to choose the right. Satan does not want us to be happy, and he knows that wrong choices will make us unhappy.

Satan Wanted Jesus Christ to Make Wrong Choices

Scripture story

Tell the story of Jesus Christ being tempted in the wilderness, as found in Matthew 4:1–11. Explain that after Jesus was baptized, he wanted to be alone to fast and pray so he could feel closer to Heavenly Father. He fasted for forty days and forty nights. That means that he didn’t eat anything for forty days.

- How do you feel when you have not eaten anything for a long time?
- How do you think Jesus felt after fasting for forty days?

Explain that Satan thought this would be a good time to tempt Jesus because he would be very hungry and weak from not eating. Satan wanted to tempt Jesus to use his power in the wrong way.

Bring out the stones, the paper crown, and picture 2-22, Temple Used Anciently. Ask the children to listen carefully to see what these things have to do with the temptations Satan offered Jesus.

Hold up the stones. Read aloud Matthew 4:3. Explain that Satan first tried to get the Savior to turn the stones into bread. Jesus knew that it was not right to use his power to do this even though he was hungry. Instead he told Satan that food is not as important as doing what is right (see Matthew 4:4).

Hold up picture 2-22, Temple Used Anciently. Explain that Satan next tried to get the Savior to prove he was the Son of God by jumping off the temple. Satan told Jesus that if he jumped and angels saved him from getting hurt, that would prove he was the Son of God (see Matthew 4:6). Jesus refused to do what Satan dared him to do. He knew that it was not right to do foolish things and expect Heavenly Father to protect him (see Matthew 4:7).

Hold up the crown. Explain that Satan tried one more temptation. Satan said Jesus could have all the rich and powerful kingdoms of the world if he would fall down and worship Satan (see Matthew 4:8–9). Jesus knew that he should worship only Heavenly Father. He commanded Satan to leave.

Scripture

Read aloud from Matthew 4:10 what Jesus said to Satan: “Get thee hence, Satan.” Have the children stand and repeat these words.

Explain that Jesus always chose the right because he loved the right and had promised to obey all of Heavenly Father’s commandments.

We Can Choose the Right As Jesus Did

CTR chart

Display the CTR chart and have the children repeat the words on the chart. Explain that we become more like Jesus by always trying to make right choices. Heavenly Father will help us if we try to choose the right.

Review game

Help the children play the “Choose the Right” game. Tell the children the game will help them remember how Jesus Christ always chose the right and how they can also choose the right.

Divide the class into two teams and give each team a button or other small object as a marker. Have each team place its marker on the space on the game board labeled “Go.” Have the children on each team take turns choosing questions from the papers you have prepared (the questions may be used more than once). Read each question and let the team members answer it together. If they answer correctly, they move their marker the number of spaces indicated after the question. If they answer a question incorrectly, they must leave their marker on the same square.

If a team lands on a “CTR” square, they climb up the ladder to the square above. If they land on a “WC” (wrong choice) square, they slide down to the square below.

Questions for the Game

1. Why did young Rex Pinegar run in front of a car? *(Move ahead two spaces.)*
2. Was Elder Pinegar glad or sad that he took the dare? *(Move ahead one space.)*
3. How many days did Jesus Christ fast and pray in the wilderness? *(Move ahead two spaces.)*
4. Who tried to tempt Jesus? *(Move ahead three spaces.)*
5. What does it mean to fast? *(Move ahead five spaces.)*
6. How many different ways did Satan try to tempt Jesus? *(Move ahead two spaces.)*
7. What did Satan want Jesus to do with the stones? *(Move ahead four spaces.)*
8. What did Satan want Jesus to do from the top of the temple? *(Move ahead three spaces.)*
9. What did Satan promise Jesus if he would fall down and worship him? *(Move ahead five spaces.)*
10. Did Jesus do what Satan wanted him to do? *(Move ahead three spaces.)*

11. What do Heavenly Father and Jesus Christ want us to do when someone dares us to do something wrong or foolish? (*Move ahead five spaces.*)
12. What should we do when we have a choice to make? (*Move ahead six spaces.*)
13. What is a temptation? (*Move ahead six spaces.*)
14. Will we be happy or unhappy if we make wrong choices? (*Move ahead one space.*)
15. When someone dares you to do something, do you have to do it? (*Move ahead two spaces.*)

Answers to Questions

1. He accepted his friend's dare to do it.
2. Sad.
3. Forty.
4. Satan.
5. Not eat or drink anything.
6. Three.
7. Change them to bread.
8. Jump off to prove he was the Son of Heavenly Father.
9. All the kingdoms of the world and their power.
10. No.
11. Choose the right.
12. Choose the right.
13. A dare to do something wrong.
14. Unhappy.
15. No.

Summary

Teacher presentation

Explain that even though Jesus Christ was tempted, he always chose the right. Remind the children that when they need to make choices they can ask themselves, "What would Heavenly Father and Jesus want me to do?" They can also sing "Dare to Do Right" (or "Choose the Right") and look at their CTR rings. These things will remind them to choose the right.

CTR chart

Have the children again say the words on the CTR chart.

Testimony

Testify to the children that choosing the right will make them happy. You may want to tell about a time when someone dared you to make a foolish choice. Explain the choice you made and how you felt about it afterward.

Encourage the children to choose the right when someone dares them to do something foolish.

Invite a child to give the closing prayer.

Enrichment Activities

Choose from the following activities those that will work best for the children in your class. You can use them in the lesson itself or as a review or summary. For additional guidance, see “Class Time” in “Helps for the Teacher.”

1. Help the children say the following words or sing them to the tune of “If You’re Happy” (*Children’s Songbook*, p. 266), using the actions indicated:
 - To show I choose the right I tell the truth (*pat lips [or clap hands] and turn around*).
 - To show I choose the right I tell the truth (*pat lips and turn around*).
 - I know the Savior’s way and it shows in what I say;
 - To show I choose the right, I tell the truth (*pat lips and turn around*).

You may want to sing or say the song several more times, replacing “I tell the truth” with other phrases such as “I will be kind” or “I say my prayers.”
2. Help the children act out how they would dare to do right in situations where they have a choice to make. Use the situations below or create some of your own:
 - a. A friend dares you to steal some candy from the store.
 - b. Other children in your Primary class are teasing a new boy about the way he is dressed.
 - c. Your little sister breaks your favorite toy.
 - d. Your mother has just asked you to do several chores for her when your friend comes to the door and asks you to come outside and play.
 - e. Your friends dare you to run into the busy street to get the ball they were playing with.
 - f. A stranger offers you candy.
3. Show picture 2-38, The First Vision, and briefly tell the story of the First Vision, as found in Joseph Smith—History 1:14–20. Explain that when Joseph Smith told other people that he had seen Heavenly Father and Jesus Christ, many people didn’t believe him. They made fun of him and called him names. They wanted him to say the vision wasn’t real (see JS—H 1:21–26). But Joseph Smith dared to do right—he did the things that Heavenly Father and Jesus Christ wanted him to do.
4. Give each child a copy of the CTR shield (found at the front of the manual) and crayons or pencils. Let the children color their shields. Explain to the children that daring to do right can be like a shield and protect them from the consequences of foolish choices. Ask the children to put their shields somewhere in their homes where they will remind the children to choose the right.

Choose
the
Right

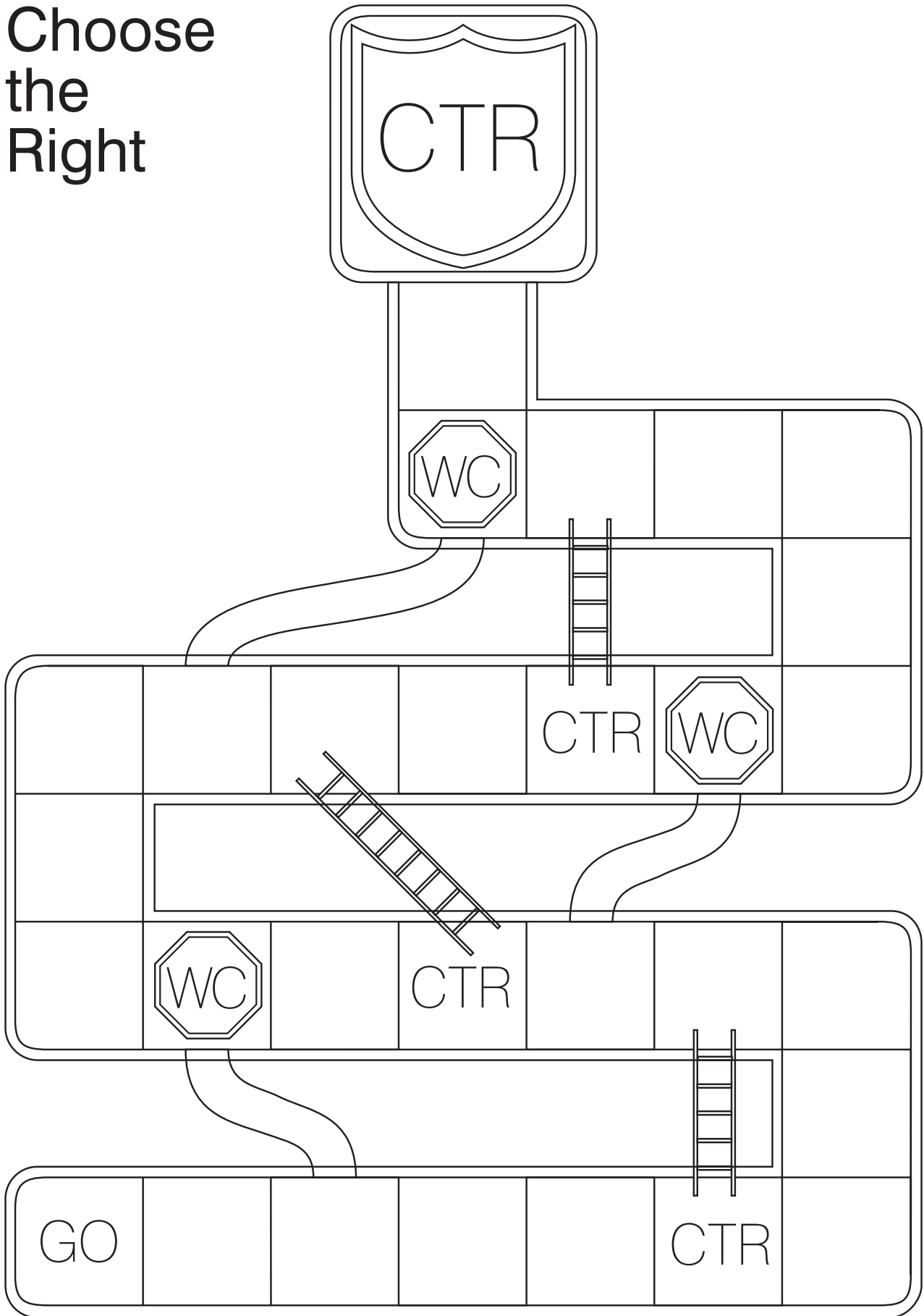

Purpose To strengthen each child's desire to follow Jesus Christ.

Preparation

1. Prayerfully study Matthew 4:18–22, Luke 5:1–11, and John 14:15, 15:17.
2. Cut out three sets of large paper footprints. Write the following on the footprints:
 - a. Come / Follow Me
 - b. Keep / My Commandments
 - c. Love / One Another

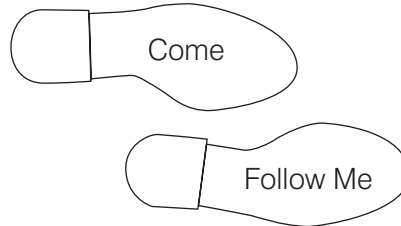

3. Prepare to sing or say the words to the first verse of “Come, Follow Me” (*Hymns*, no. 116).
 4. Materials needed:
 - a. A Bible.
 - b. CTR chart (see lesson 1).
 - c. Two pieces of paper and a pencil for each child.
 - d. Picture 2-23, Child Following in His Father's Footsteps; picture 2-24, Calling of the Fishermen (Gospel Art Picture Kit 209; 62496).
 5. Make the necessary preparations for any enrichment activities you want to use.
-

**Suggested
Lesson
Development**

Invite a child to give the opening prayer.

Follow up with the children if you encouraged them to do something during the week.

Jesus Christ Wants Us to Follow Him

Attention activity

Let the children play “Follow the Leader.” Have the children stand in a line at one side of the room. The first child in line runs, hops, skips, or does some other action to the other side of the room. The other children follow the first child, doing what he or she did. Then the first child goes to the end of the line and the second child becomes the leader. Continue until each child has had a turn to be the leader.

Tell the children that in today's lesson they will learn about following Jesus Christ.

Story

Display picture 2-23, Child Following in His Father's Footsteps, and tell the following story in your own words (if the children in your class are unfamiliar with snow, you may want to adapt the story to fit your own climate and environment):

Sam went out to help his father gather wood for the fire. It was winter and the snow was very deep. Sam and his father each took an armload of wood and started back toward their home. It was hard for Sam to walk in the deep snow with his heavy load. Sam's father told Sam to walk in the footprints that he left in the snow. It was much easier for Sam to walk when he followed his father's footsteps.

- Why did Sam follow his father's footsteps?
- Why do you think it was easier for Sam to walk in the snow when he followed his father's footsteps?

Scripture story

Display picture 2-24, Calling of the Fishermen. Tell the story found in Matthew 4:18–22 and Luke 5:1–11. Explain that when Jesus Christ was on the earth he called men to be his disciples, or helpers.

As you tell the story, read aloud Matthew 4:19 at an appropriate time. Explain that "I will make you fishers of men" meant that Jesus wanted these men to help him teach the people.

- Why did these fishermen follow Jesus?
- What would you do if Jesus asked you to follow him and be his disciple?

Discussion

Compare the story of Jesus Christ calling his disciples with the story about Sam and his father. Just as Sam's father asked Sam to follow him, Jesus asks all of us to follow him. Sam's father knew that it would be easier for Sam to walk if he followed his father's footsteps. The Savior knows that our lives will be easier and we will be happier if we follow him.

- What does it mean to follow Jesus?
- Why is life easier for us when we follow Jesus?

Song

Sing or say the words to the first verse of "Come, Follow Me," explaining any words that are unfamiliar to the children (such as *tread*).

"Come, follow me," the Savior said.
Then let us in his footsteps tread,
For thus alone can we be one
With God's own loved, begotten Son.

Explain that we can follow Jesus by trying to be like him and by obeying his commandments. When we learn his ways and do what he asks us to do, we are following his footsteps.

Footprint activity

Show the two footprints with "Come" and "Follow Me" printed on them. Read the words with the children. Have the children repeat the phrase a few times.

Display the CTR chart at the front of the room. Have a child place the footprints on the floor on the other side of the room. (As the lesson progresses and each set of footprints is placed on the floor, they should form a path on which a child can walk toward the picture of the Savior on the CTR chart.)

Jesus Wants Us to Keep the Commandments

Scripture discussion

Explain that following Jesus Christ means being willing to do what he has asked us to do. Ask the children to listen while you read about one of the things Jesus has asked us to do.

Read aloud John 14:15. Explain that these are Jesus' words. Have the children repeat the scripture with you.

- What did Jesus say we must do?
- What does it mean to keep Jesus' commandments?

Footprint activity

Show the footprints labeled "Keep" and "My Commandments" and have the children repeat the phrase. Ask a child to place these footprints a short distance in front of the first set of footprints. (The footprints should be close enough that a child can step from one to the next.)

Discussion

Describe for the children some situations in which they could follow Jesus. Have the children take turns explaining what they would do in each situation. Use the examples below or create some situations that are more appropriate for your class:

1. You are playing at school and find a purse with money in it.
 - How will you follow Jesus?
2. You are ready for bed and are so tired that you want to go to sleep right away.
 - How will you follow Jesus before climbing into bed?
3. Your mother has asked you to watch your little sister so she won't run into the street. Some friends come by and invite you to go play with them.
 - How will you follow Jesus?
4. A new boy has started attending your school, and some of the children make fun of him.
 - How will you follow Jesus?
5. Some friends have invited you to go with them to visit relatives, but they won't be back in time for you to go to church.
 - How will you follow Jesus?

Invite the children to describe other situations in which they could choose to follow Jesus. Point out that when we follow Jesus by doing what he wants us to do, we are choosing the right.

Jesus Wants Us to Love One Another

Scripture

To help the children discover another way they can follow the footsteps of Jesus, read aloud John 15:17. Explain that these are Jesus' words. Have the children repeat the scripture with you.

- Whom does Jesus want us to love?

Footprint activity

Show the footprints labeled "Love" and "One Another." Read these words with the children and have them repeat the phrase. Ask a child to place the footprints in the same manner as before.

Story

Tell or read the following story about how a young boy named Heber followed Jesus Christ:

Heber shivered in the cold and wrapped his thin coat around him. It would soon be his birthday, and all he wanted was a warm coat. But he knew his mother would be sad if he asked for one, because she could not afford to buy him one. Heber's father had died when Heber was a baby, and Heber's mother worked very hard to earn the money they needed. She would often sew until late at night, making clothes for other people.

On the day of Heber's birthday, his mother wished him a happy birthday and handed him a beautiful coat she had sewn for him. Heber could hardly wait to wear it outside and feel how warm it would keep him.

A few weeks later while on an errand, Heber saw a boy who was wearing only a sweater. Heber knew how cold he must feel. Almost without thinking, Heber took his coat off and gave it to the boy.

When Heber's mother saw him wearing his old coat, she asked him what had happened to his new coat.

Heber explained, "I saw a boy and he needed it lots worse than I did so I just gave it to him."

His mother asked, "Couldn't you have given him your old one?"

Heber looked up at his mother, hoping she would understand, and saw her eyes fill up with tears. She hugged him tightly as she said, "Of course you couldn't, Heber." (See Lucile C. Reading, "The Coat," *Children's Friend*, Nov. 1966, p. 5.)

- How did Heber follow Jesus Christ?

Tell the children that the boy in this story was Heber J. Grant, who grew up to become the seventh President of the Church.

Discussion

Have the children think of ways they can show love for others. You may want to use questions such as the following to help them think of ideas:

- If you saw someone fall and get hurt, what could you do to show love?
- If someone at school didn't have a lunch, what could you do to show love?

Explain that loving others is more than feelings or words. We show our love by what we do. Invite the children to tell about how they have shown love for other people during the past week.

We Will Choose the Right and Follow Jesus Christ

Footprint activity

Give each child the opportunity to step from footprint to footprint and then stand by the picture of Jesus on the CTR chart. Have each child tell one thing he or she will do this week to follow Jesus.

Remind the children that we follow Jesus Christ when we choose the right. Point to the CTR chart and have the children repeat "I will choose the right."

Summary

Activity

Give each child two pieces of paper and a pencil. Let the children make sets of footprints by tracing their own shoes. Write or have them write *I will follow Jesus Christ* at the top of their papers. Let the children take their footprints home to help them remember their commitment to follow Jesus.

Testimony

Tell the children how following Jesus Christ has made you happy. Testify that if we follow him, Jesus will lead us back to live with our Heavenly Father again.

Encourage the children to always try to follow the footsteps of Jesus. Suggest that they discuss their paper footprints with their parents.

Invite a child to give the closing prayer. Suggest that the child ask Heavenly Father to help the children follow Jesus Christ and choose the right.

**Enrichment
Activities**

Choose from the following activities those that will work best for the children in your class. You can use them in the lesson itself or as a review or summary. For additional guidance, see “Class Time” in “Helps for the Teacher.”

1. Explain to the children that you are going to do an action (such as clapping, nodding, or marching). Ask them to repeat your action. Do this once; then add another action and have the children repeat both actions. Continue adding new actions, one at a time. See how many the children can remember and repeat in the right order.

Liken this to following the Savior. We must try to follow his example not just in one thing but in everything we do.

2. Prepare a chain of paper dolls for each class member. (Older children may enjoy making their own chains.) Fold a piece of paper accordion-style. Draw a doll onto the folded paper (see illustration below) and cut out the doll. Make a chain for each child, and write *Love One Another* across the bottom of each chain. Explain that loving each other is one of the most important things Jesus has asked us to do.

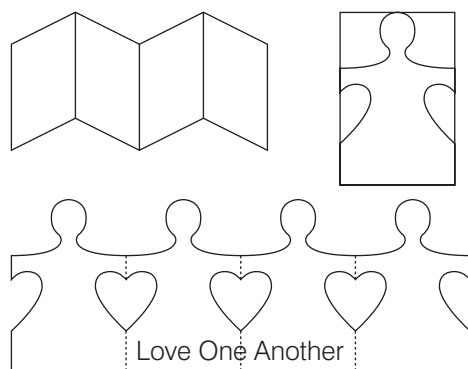

3. Sing or say the words to the first verse of “I’m Trying to Be like Jesus” (*Children’s Songbook*, p. 78), “Love One Another” (*Children’s Songbook*, p. 136), or “Keep the Commandments” (*Children’s Songbook*, p. 146). The words to “I’m Trying to Be like Jesus” and “Love One Another” are included at the back of the manual. The words to “Keep the Commandments” are on the next page.

Keep the Commandments

Keep the commandments;
Keep the commandments!
In this there is safety;
In this there is peace.
He will send blessings;
He will send blessings.
Words of a prophet:
Keep the commandments.
In this there is safety and peace.

Jesus Christ Has the Power to Heal

Lesson 16

Purpose To help each child understand that Jesus Christ has the power to heal and that priesthood blessings can help heal the sick.

Preparation

1. Prayerfully study Matthew 9:18–19, 23–26; Mark 5:22–24, 35–43; Luke 8:41–42, 49–56; James 5:14–15; and Doctrine and Covenants 42:48.
2. Copy or trace the drawings found at the end of the lesson and cut them apart. These drawings will be used in the “What Am I?” activity.
3. Materials needed:
 - a. A Bible and a Doctrine and Covenants.
 - b. A first aid kit or sack containing a few items that help people heal when they are sick or injured, such as salve, bandages, and cough syrup.
 - c. A small bottle of consecrated oil.
 - d. Picture 2-25, Jesus Blessing Jairus’s Daughter (Gospel Art Picture Kit 215; 62231); picture 2-26, Jesus Healing the Sick; picture 2-27, Administering to the Sick (62342).
4. Make the necessary preparations for any enrichment activities you want to use.

**Suggested
Lesson
Development**

Invite a child to give the opening prayer.

Follow up with the children if you encouraged them to do something during the week.

We Sometimes Get Sick

Attention activity

Show the children the first aid kit or sack and explain that inside it are some things that help us heal when we are sick or injured. Give the children clues about each item to help them guess what it is (for example, “It helps keep germs and dirt out of sores and cuts”).

When the children guess each item, show it to them and talk briefly about how it is used to help people heal. Remind the children not to use these items without their parents’ help.

Teacher presentation

Explain that almost everyone gets sick or hurt. Sometimes hurts or sicknesses last just a little while and our parents can easily take care of us, but other times our illnesses are serious and our parents need to take us to a doctor for help.

Explain that there is another way we can be helped when we are sick. When Jesus Christ lived on the earth he blessed many people and made them well. He used the power of the priesthood to heal them.

Jesus Christ Healed the Sick

Scripture story

Show picture 2-25, Jesus Blessing Jairus's Daughter, and tell the story of Jesus raising Jairus's daughter, as found in Luke 8:41–42, 49–56 (see also Matthew 9:18–19, 23–26 and Mark 5:22–24, 35–43).

Explain that Jairus had great faith. He believed that if Jesus came and blessed his sick daughter, she would get well. As Jesus went to Jairus's home, many other people crowded around him, asking for his help. While Jesus was helping another sick woman, a man came with a message for Jairus.

Read aloud Luke 8:49–50.

- What did the messenger tell Jairus? (See Luke 8:49.)
- What did Jesus tell Jairus? (See Luke 8:50.)

Explain that when Jesus arrived at Jairus's home, he told the people not to cry, because the girl was not dead. But the people laughed at Jesus and made fun of him because they thought she was dead (see Luke 8:52–53).

Jesus sent all the people away except his disciples Peter, James, and John and Jairus and Jairus's wife. Then Jesus took the girl by the hand and told her to arise. The girl got up from her bed, completely well again.

- Why do you think Jesus sent everyone out of the house except Peter, James, John, and the girl's parents? (Perhaps because the other people were laughing at him and did not believe he could heal the girl. They did not have faith.)
- Why was Jesus able to heal Jairus's daughter? (He had the priesthood; the girl's parents had faith.)

Teacher presentation

Show picture 2-26, Jesus Healing the Sick, and ask the children to imagine how it would feel to have Jesus come to bless them when they were sick. Emphasize that Jesus loves each of them as much as he loved the children who lived on the earth when he did. Although he isn't here on the earth now, he has given righteous men the priesthood and the power to act for him. They can give us blessings to heal us just as Jesus would if he were here.

Men Who Hold the Priesthood Can Administer to Us

Discussion

Display picture 2-27, Administering to the Sick.

- What is happening in this picture?

Explain that when men who hold the Melchizedek Priesthood give a blessing to someone who is sick, we call this administering to the sick. Have the children repeat the word *administer* several times.

Show the children the bottle of consecrated oil. Explain that this oil has been specially blessed by men who hold the priesthood. When someone is sick and needs help to get well, two men who hold the Melchizedek Priesthood use the oil and give a blessing to the sick person (see James 5:14–15).

- Have you ever been administered to?

Let the children tell about any priesthood blessings they have had or have seen in their families. You may want to tell the children about a time when priesthood holders administered to you or a family member.

Story	<p>Tell a story about someone who was healed through a priesthood blessing. A true story about you or someone else the children know, such as a ward or branch member, will be most effective. If you do not know of such a story, you may want to use the following story:</p> <p>When Jessica arrived home from school, her father met her at the door and told her that her new baby brother had been born that morning. The baby had come sooner than expected and was very tiny and weak. The doctor said the baby might not live more than a few hours.</p> <p>Jessica could see how worried her father was. She was sad because she wanted the baby to live.</p> <p>Jessica's father called one of their home teachers to come and help him give the baby a blessing. When the home teacher arrived, they all went to the bedroom where Jessica's mother and new brother were. Jessica's father and the home teacher gently placed their hands on the new baby's tiny head, and Jessica's father blessed him to live to fulfill his mission on earth. Warm comfort and peace filled Jessica. She knew that because of the power of the priesthood, her little brother would grow and become strong. (Adapted from "Moments to Remember," <i>Children's Friend</i>, Feb. 1963, p. 41.)</p>
Teacher presentation	<p>Explain that Heavenly Father and Jesus love every person who asks to be healed, but sometimes people are not healed even when they are administered to. Some are not healed because Heavenly Father knows they can become stronger people by learning to live with their sickness or disability. Others are not healed because it is the right time for them to die and go back to Heavenly Father (see D&C 42:48). We must have faith that Heavenly Father knows the best answer to each prayer.</p>
Activity	<p>Have several children come to the front of the class and hold the drawings for the "What Am I?" activity. Have the children tell what the drawings represent.</p> <p>Explain that you are going to read some descriptions of things and people involved in administering to the sick. Have the children decide which drawing fits each description.</p> <ol style="list-style-type: none"> 1. I am used when a sick person is given a blessing. The priesthood holder puts a few drops of me on the sick person's head. What am I? (Consecrated oil.) 2. I showed people how to live. Faith in me can help people overcome illness. Who am I? (Jesus Christ.) 3. I need a special blessing. I have a fever. I asked my father to give me a blessing to help me feel better. Who am I? (A sick child.) 4. I have been given a special power called the priesthood. I can use that power to give people blessings. Who am I? (A man who holds the Melchizedek Priesthood.) 5. When a sick person asks for a blessing, men who hold the Melchizedek Priesthood are called in. Usually a certain number of men participate. I am that number. What am I? (The number 2.) 6. When men who hold the priesthood bless the sick, they put me on the sick person's head. What am I? (Hands.)

Summary

- Review discussion Show the first aid kit or sack again.
- What do we use these items for?
 - What else can help us heal when we are sick or injured?
- Testimony Bear testimony about the greatness of Jesus Christ and his power to heal. Tell the children how thankful you are that Jesus has given righteous men the Melchizedek Priesthood so they can bless us when we are sick.
- Ask the children to think about how they can share what they have learned with their families. Encourage the children to tell their families the story of how the Savior healed Jairus's daughter.
- Invite a child to give the closing prayer.

Enrichment Activities

Choose from the following activities those that will work best for the children in your class. You can use them in the lesson itself or as a review or summary. For additional guidance, see “Class Time” in “Helps for the Teacher.”

1. Print *We believe in the gift of healing* on the chalkboard and explain that Joseph Smith gave us this great truth as part of the seventh article of faith. Have the children stand and repeat the sentence. Help them memorize it by erasing one or two words at a time. Have the children continue to repeat the sentence until it has been completely erased and memorized.
2. Sing or say the words to the first verse of “Faith” (*Children’s Songbook*, p. 96), using the actions indicated below. Remind the children that faith is important to healing.

Faith is knowing the sun will rise (*form a circle over the head with arms*),
lighting each new day (*slowly drop arms to shoulder level*).

Faith is knowing the Lord will hear (*cup hand behind ear*) my prayers each time I pray (*bring hands together as if in prayer*).

Faith is like a little seed (*form a cup with left hand and imitate planting a seed with right hand*):

If planted, it will grow (*use right hand to imitate a plant growing from the cupped left hand*).

Faith is a swelling within my heart (*place hands over heart*).

When I do right (*point upward with right index finger*), I know (*touch head with right index finger*).
3. Tell the story of Jesus Christ healing the Nephites, as found in 3 Nephi 17:5–9. If possible, use picture 317 in the Gospel Art Picture Kit (or 62541 in the meetinghouse library) to illustrate the story. Have the children touch on their own bodies some of the things that Jesus healed, such as eyes, ears, and legs. Talk with the children about how wonderful the Nephites must have felt when Jesus healed them. Read aloud the last part of verse 8 (from *for I see*) and remind the children that it is important to have faith in Jesus Christ.
4. Make each child a copy or tracing of the pictures at the end of the lesson. Give the children crayons and let them color the pictures. Encourage them to use the pictures to tell their families how sick people can be blessed through priesthood blessings.

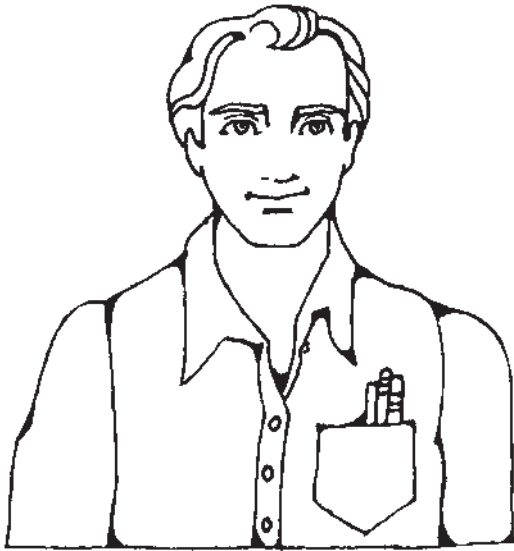
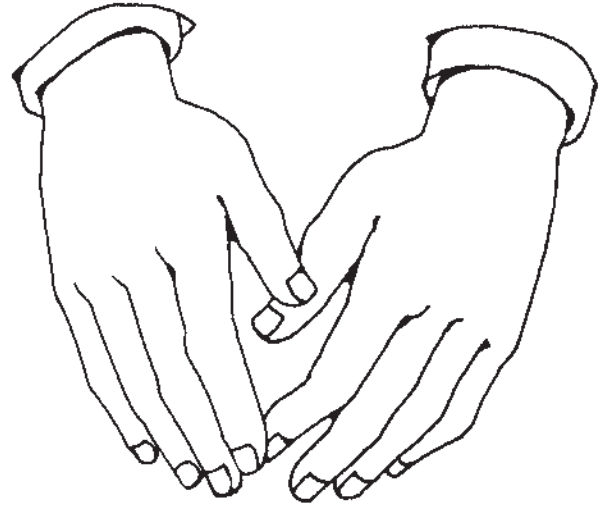
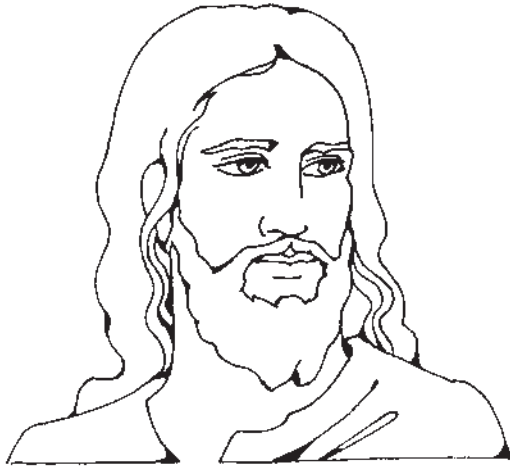

2



Purpose	To help each child understand how the priesthood can help us.
Preparation	<ol style="list-style-type: none"> 1. Prayerfully study Mark 4:35–41. See also <i>Gospel Principles</i> (31110), chapter 13. 2. Prepare to sing or say the words to the first verse and chorus of “Master, the Tempest Is Raging” (<i>Hymns</i>, no. 105). Also prepare to explain the meaning of some of the more difficult words to the children. 3. Materials needed: <ol style="list-style-type: none"> a. A Bible. b. A flashlight or small lamp. If it is not possible to bring one, use the light in your classroom. c. Picture 2-20, Boy Being Baptized (62018); picture 2-27, Administering to the Sick (62342); picture 2-28, Stilling the Storm (Gospel Art Picture Kit 214; 62139); picture 2-29, Passing the Sacrament (62021); picture 2-30, Girl Being Confirmed (62020); picture 2-31, Blessing a Baby; picture 2-32, Newly Married Couple in Front of the Temple; picture 2-33, A Father Blessing His Daughter. 4. Make the necessary preparations for any enrichment activities you want to use. <p><i>Note:</i> Be sensitive to the feelings of children in your class who do not have fathers in their homes or whose fathers do not hold the priesthood.</p>

Suggested Lesson Development

Invite a child to give the opening prayer.

Follow up with the children if you encouraged them to do something during the week.

The Priesthood Is the Greatest Power

Attention activity	<p>Use a flashlight, a small lamp, or the light fixture in your classroom to help illustrate the meaning of the word <i>power</i>. Begin the discussion with the light off. Point out that although all the parts seem to be properly in place, the flashlight or lamp is not giving off light.</p> <ul style="list-style-type: none"> • What must happen before the light will work? <p>Let a child show what happens when the light is switched on. Explain that the flashlight or lamp must have electrical power before it will give off light.</p>
Scripture story	<p>Tell the children that this lesson is about another kind of power—a power even greater than electricity. Invite the children to listen to the following story and to think about what kind of power is being used. Tell the story found in Mark 4:35–41.</p> <ul style="list-style-type: none"> • How would you feel if you were on a boat during a bad storm?

Explain that the disciples woke Jesus Christ because they were frightened of the storm. Read aloud what the disciples asked Jesus in the last part of Mark 4:38 (from *Master*). The disciples were afraid that the storm would sink the boat and they would all die.

Show picture 2-28, *Stilling the Storm*, and read aloud Mark 4:39 to see what Jesus did. Have the children repeat Jesus' words: "Peace, be still."

Explain that the disciples were amazed that the storm was calmed so quickly. Read aloud from Mark 4:41 what they asked each other: "What manner of man is this, that even the wind and the sea obey him?" Jesus' disciples were surprised that he had the power to control the wind and the waves.

Song

Sing or say the words to the first verse and chorus of "Master, the Tempest Is Raging." Before you begin, tell the children that this is a song about the story they have just heard. Ask them to listen for Jesus' words ("Peace, be still") in the chorus. (The words to this song may be difficult for young children to understand, but the Spirit can help them understand the meaning of the song. You may want to explain some of the more difficult words to the children.)

You may want to help the children pantomime various actions as you sing or say the words. They could move back and forth as if in a rocking boat, make wave-like movements with their hands, show the fear on the disciples' faces, and so on.

Master, the tempest is raging!
The billows are tossing high!
The sky is o'ershadowed with blackness.
No shelter or help is nigh.
Carest thou not that we perish?
How canst thou lie asleep
When each moment so madly is threat'ning
A grave in the angry deep?

Chorus:

The winds and the waves shall obey thy will:
Peace, be still.
Whether the wrath of the storm-tossed sea
Or demons or men or whatever it be,
No waters can swallow the ship where lies
The Master of ocean and earth and skies.
They all shall sweetly obey thy will:
Peace, be still; peace, be still.
They all shall sweetly obey thy will:
Peace, peace, be still.

- What great power did Jesus Christ have that enabled him to stop the storm? (The power of the priesthood, which is the power to act in Heavenly Father's name.)

Have the children say *priesthood* aloud.

We Can Be Blessed by the Priesthood

Teacher
presentation

Explain that many men in the Church have this same power. Heavenly Father and Jesus Christ give the priesthood to worthy men in the Church. When these

men are directed by Heavenly Father, they can use the priesthood to help us and bless us.

- Whom do you know who holds the priesthood?

Picture discussion

Show the pictures of priesthood ordinances, one at a time. Let the children hold or point to the pictures and help tell what is taking place in each one. Emphasize that all these things are done by men who hold the priesthood. Let the children talk about any experiences they have had with these ordinances.

Show picture 2-27, Administering to the Sick. Remind the children of the things they learned in lesson 16 about administering to the sick. Help the children remember that men who hold the priesthood can give blessings to people who are sick to help them get well.

- Have you ever been administered to because you were sick?

Show picture 2-29, Passing the Sacrament. Explain that priests in the Aaronic Priesthood or men who hold the Melchizedek Priesthood bless the sacrament, and deacons in the Aaronic Priesthood pass the sacrament. Let the children tell about their older family members or friends who help with the sacrament.

Show picture 2-20, Boy Being Baptized. Remind the children that we are each baptized by a man who holds the priesthood, just as Jesus Christ was. John the Baptist held the priesthood, so he was able to baptize Jesus.

- Have any of you ever been to a baptism? (If any of the children have already been baptized, you may want to ask them to tell about their baptisms.)

Show picture 2-30, Girl Being Confirmed. Remind the children that after they are baptized, men who hold the Melchizedek Priesthood will confirm each of them a member of The Church of Jesus Christ of Latter-day Saints. At this time they are also given the gift of the Holy Ghost through the power of the priesthood.

Show picture 2-31, Blessing a Baby. Tell the children that babies in the Church can have a priesthood blessing when they are named. Have the children tell you of a baby they know who was recently blessed in this manner. (If some of the children are concerned because they were not blessed this way as babies, assure them that they will have many other opportunities to receive priesthood blessings.)

Show picture 2-32, Newly Married Couple in Front of the Temple. Explain that when the children are older, they will be able to go to the temple to be married. Men who hold the sealing powers of the priesthood marry righteous couples in the temple. Temple marriage makes it possible for a family to be together forever.

Story

Tell the children that they can receive a priesthood blessing when they have a problem. Show picture 2-33, A Father Blessing His Daughter, and tell a story about a girl who was blessed by the priesthood when she had a problem. You may want to use the following story:

Susanne was getting ready for the first day of school. She had been excited about beginning school, but now that the first day had finally come she was frightened.

Susanne was quiet all morning. Her mother had made her favorite breakfast, but Susanne did not smile when she saw it. She tried to eat, but she could not.

Susanne told her mother that she felt sick. Her mother felt her head to see if she had a fever. She looked in her throat, but it was not red. Susanne's mother asked her where she felt sick. Susanne said she just felt funny inside.

Susanne's father said she probably felt funny inside because it was the first day of school. She was a little frightened because she would be away from home all day and didn't know what to expect. Susanne's father explained that he had the same feeling when he started his new job.

Susanne's father offered to give her a blessing before she went to school. The blessing would help take away the frightened, funny feeling Susanne had. Susanne's father placed his hands on her head and gave her a special blessing.

When Susanne came home that afternoon, she was happy. She told her mother that she liked school and her teacher was nice. Susanne was glad her father gave her a special blessing to help her feel better at school.

Explain that this kind of blessing is often called a father's blessing. If our fathers are not able to give us blessings, we can ask other men who hold the Melchizedek Priesthood, such as our home teachers, other family members, or the bishop or branch president, to give us blessings when we need them.

Summary

Picture review

- When might we need or want a priesthood blessing?

Show each picture as the children mention the ordinance that it illustrates. Have the children say aloud together the name of each ordinance or blessing. Mention that these are only a few of the things the power of the priesthood can do for us.

Testimony

Bear testimony of your gratitude that we have the priesthood—the same power Jesus has—to help us in our lives.

Encourage the children to ask for a priesthood blessing from their fathers (or another Melchizedek Priesthood holder) when they need one.

Invite a child to give the closing prayer. Suggest that the child express gratitude for the blessings of the priesthood.

Enrichment Activities

Choose from the following activities those that will work best for the children in your class. You can use them in the lesson itself or as a review or summary. For additional guidance, see "Class Time" in "Helps for the Teacher."

1. With the approval of your Primary president, invite a parent of a child in your class to tell about the naming and blessing of the child. Ask the parent to tell how the parents felt, how they dressed the baby in nice clothes, and how special it was to have the home teachers and family members and other close friends watch or participate. Also ask the parent to tell how the father felt to be able to use the power of the priesthood to give the baby a name and a blessing.
2. Have the children role-play the story from Mark 4:35–41.
3. Give the children paper and crayons or pencils, and let each child draw a picture of a priesthood ordinance, such as passing the sacrament. Label each child's picture with the name of the ordinance illustrated.

4. Sing or say the words to one or more of the following songs about priesthood ordinances: "The Priesthood Is Restored" (*Children's Songbook*, p. 89), "Before I Take the Sacrament" (*Children's Songbook*, p. 73), "I Love to See the Temple" (*Children's Songbook*, p. 95), "Baptism" (*Children's Songbook*, p. 100), "The Holy Ghost" (*Children's Songbook*, p. 105). The words to "Baptism" and "The Holy Ghost" are included at the back of the manual.

The Priesthood Is Restored

The priesthood is restored,
The truth made known to man,
That God has spoken to the earth,
His pow'r is here again.

Before I Take the Sacrament

Before I take the sacrament, I sit so quietly.
I know that Jesus came to earth and died for me.

I think of all the boys and girls whom Jesus used to know,
The days he walked upon the earth, so long ago.

I take the water and the bread and try so hard to be
The kind of child that Jesus loved in Galilee.

I Love to See the Temple

I love to see the temple.
I'm going there someday
To feel the Holy Spirit,
To listen and to pray.
For the temple is a house of God,
A place of love and beauty.
I'll prepare myself while I am young;
This is my sacred duty.

I love to see the temple.
I'll go inside someday.
I'll cov'nant with my Father;
I'll promise to obey.
For the temple is a holy place
Where we are sealed together.
As a child of God, I've learned this truth:
A fam'ly is forever.

(© 1980 by Janice Kapp Perry. Used by permission.)

Prayers Are Answered in the Best Way

Lesson

18

Purpose To help each child understand that Heavenly Father always hears our prayers and answers them in the best way.

Preparation

1. Prayerfully study Luke 1:5–17. See also *Gospel Principles* (31110), chapter 8.
2. Prepare to sing or say the words to all three verses of “Quickly I’ll Obey” (*Children’s Songbook*, p. 197). The words to this song are included at the back of the manual.
3. Prepare to share a personal experience when Heavenly Father helped you in answer to a prayer.
4. Materials needed:
 - a. A Bible.
 - b. Picture 2-34, Naming of John the Baptist.
5. Make the necessary preparations for any enrichment activities you want to use.

**Suggested
Lesson
Development**

Invite a child to give the opening prayer.

Follow up with the children if you encouraged them to do something during the week.

We Can Pray for Help

Attention activity With the children, sing or say the words to all three verses of “Quickly I’ll Obey.”

- Why should we obey our parents and Heavenly Father? (Because they can help us do what is best for us.)

Story

Tell the following story:

Meredith had a bad dream one night. She dreamed she was lost and frightened. When she woke up, she began to cry.

- What would you do if you were Meredith?

Meredith called for her father, and he came in and gave her a hug. Meredith felt better and soon went back to sleep.

- Why did Meredith call for her father? (She needed help and she knew he would help her.)
- Whom do you call when you need help? (Answers may include Heavenly Father, parents, other family members, and friends.)
- How do we call Heavenly Father and ask for his help? (Pray.)

Story	<p>Tell the children the following story about John A. Widtsoe, who grew up to become a member of the Quorum of the Twelve Apostles:</p> <p>John's father died when he was young, and John's mother worked hard to support her children. John wanted to get a job to help her. It was not easy to find a job he could do after school, but he finally found one. One day the man he worked for told him he had done a good job for several weeks and paid him with a five-dollar gold piece.</p> <p>John said: "Five dollars! That was money! I was jubilant! I would give half of it to my mother; I would buy a new book, and save the remainder. Into the pocket of my trousers went the bright new gold piece, and off I ran to tell my mother of my good luck.</p> <p>"On the way home, I put my hand in the pocket to feel . . . the money. It was not there! I felt all through the pocket again. The gold piece was not there! Instead, I found a hole in the pocket through which the coin had slipped. It was terrible! I was so sorry that I sat down by the ditch bank and cried."</p> <p>John walked back along his path, looking for the gold piece. The sidewalk he had been walking on was made of planks (boards), and he searched the cracks between every plank. But he could not find the money. He finally decided the money was lost for good.</p>
Activity (optional)	<p>Have the children pretend they are John looking for the lost coin and walk around the room slowly for a few seconds as if searching for it. Then have them return to their seats.</p> <ul style="list-style-type: none"> • If you were John, what would you do next?
Story continued	<p>John said: "Then I remembered that the Lord knew where that gold piece was, and that if he would help me, and wanted me to find it, it could not be lost for long.</p> <p>"So I got down on my knees [in] back of a big tree, and told the Lord all about my trouble, and asked him, if he thought it was the best thing for me, to help me find [the gold piece]. When I got up I felt so much better. I felt sure the Lord had heard my prayer.</p> <p>"[It was getting dark]. One could not see anything on the ground very clearly, especially a small piece of gold. But I walked right on, not so slowly this time, for I knew the Lord was helping. About half way up the second block, there in the grass lay my lost five dollar gold piece. . . . I almost shouted with joy. How glad my mother would be, and how I would enjoy that book I had planned to buy. I leaned up against the fence and said, 'Thank you, O Lord, for finding my money for me.'</p> <p>"Since that time I have known that the Lord hears prayers. And, since that day, I have been careful to have no holes in my pockets" (from John A. Widtsoe, "The Lost Gold Piece," <i>Children's Friend</i>, Sept. 1947, p. 369).</p>
Discussion	<ul style="list-style-type: none"> • How many times did John pray about his coin? • What did John pray for the first time? (To ask Heavenly Father to help him find his money.) • What was the answer to John's prayer? • Why did John pray the second time? (To thank Heavenly Father for helping him.) • How has Heavenly Father helped you when you have prayed?

Teacher presentation Emphasize to the children that just like our earthly parents, Heavenly Father loves us and wants to help us. When we ask for help, Heavenly Father will hear us. Tell the children about a time when Heavenly Father helped you in answer to a prayer.

Prayers Are Answered in Different Ways

Scripture story Hold up the Bible and tell the children that the next story is from the Bible. Display picture 2-34, Naming of John the Baptist, and tell the story found in Luke 1:5–17.

Explain that Zacharias and Elisabeth were both righteous people, and they had prayed for a baby for many years. Now they were both old, and they still did not have a child.

Explain that Zacharias was surprised and a little frightened when he first saw the angel in the temple. Read aloud what the angel said to Zacharias from Luke 1:13–14. Explain that what the angel promised did happen, and Zacharias and Elisabeth had a baby boy.

Emphasize that Heavenly Father had heard all of Zacharias and Elisabeth's prayers. Until now, though, it was not time for their child to be born. The angel told Zacharias that the baby, John, would grow up to be a great prophet, John the Baptist. John was born at this time so that he could prepare many people to believe in Jesus Christ and follow him.

Teacher presentation Explain that sometimes, like Elisabeth and Zacharias, we pray for something that will be good for us later but not yet. Heavenly Father hears all our prayers and answers them in the ways and times that are best for us.

Remind the children that when John Widtsoe prayed about his lost gold coin, he remembered that Heavenly Father knew where the coin was and would help him find it "if he thought it was the best thing for me." John found the coin right away because it was best for him to find it.

Explain that sometimes we might ask our parents for something they know is not good for us, and they have to say "no." Similarly, we might pray for something that Heavenly Father knows would not be right for us, and he has to say "no."

Story Tell the following story in your own words:

While Michael was indoors with a bad cough, it snowed—the first big snowfall of the winter. Michael begged his mother to let him play outside in the snow, but she said "no." She was afraid his cough would get worse.

Michael really wanted to play in the snow, so he prayed that Heavenly Father would make his mother change her mind. When his friend Alex came and asked if he could play in the snow, Michael said that he had to eat lunch, but that he would be able to play after lunch because he had prayed that his mother would let him play in the snow.

After lunch Michael again asked his mother if he could play outside. He told her he had prayed that she would let him go outside. Michael's mother looked unhappy. She asked Michael if he thought Heavenly Father would want him to go out and play in the snow today when it might make him more sick.

- Do you think Heavenly Father heard Michael’s prayer?
- How did Heavenly Father answer the prayer?

When Alex came back, Michael said he couldn’t go outside. Alex said that Heavenly Father didn’t answer Michael’s prayer. Michael explained that Heavenly Father did answer his prayer, but the answer was “no.”

Summary

Testimony

Bear your testimony to the children that Heavenly Father knows what is best for each of us, and he always answers our prayers in the best way. Sometimes he says “yes,” sometimes “no,” and sometimes he asks us to wait awhile before we receive what we prayed for.

Review

- How did Heavenly Father answer John Widtsoe’s prayer?
- How did Heavenly Father answer Elisabeth and Zacharias’s prayers?
- How did Heavenly Father answer Michael’s prayer?

Encourage the children to accept Heavenly Father’s answers to their prayers, even when the answer is “no” or “not now.”

Invite a child to give the closing prayer.

Enrichment Activities

Choose from the following activities those that will work best for the children in your class. You can use them in the lesson itself or as a review or summary. For additional guidance, see “Class Time” in “Helps for the Teacher.”

1. Tell the children that they are going to pretend to be parents and decide what is best for their children. Ask them to answer “yes,” “no,” or “not now” to each request their children make. Describe some things that children might ask for, using the situations below or some of your own. Discuss which response is best for each situation.
 - a. It is almost dinnertime. Your child is hot and hungry and wants to eat an ice cream bar.
 - What do you say?
 - Why do you say that?
 - b. It is a cold, rainy day. Your child wants to wear a swimming suit out to play.
 - What do you say?
 - Why do you say that?
 - c. Your children have finished all their work. It is early in the afternoon. They ask if they can go play outside.
 - What do you say?
 - Why do you say that?

- d. Your child has been saving money for a toy and finally has enough. He asks to go to the store right away to buy the toy. You (the parent) are going to the store in just a few minutes.
- What do you say?
 - Why do you say that?
- e. Your child loves horses and asks to have a horse for her own. She is only five years old.
- What do you say?
 - Why do you say that?
- f. Your children are not careful with their toys or books. Rather than take care of the toys and books they have, they want to buy new ones. At the store they see one of their favorite books and ask if they can have it.
- What do you say?
 - Why do you say that?

Explain that parents want to do what is best for their children. Heavenly Father also wants to do what is best for his children. Heavenly Father always answers our prayers, and he answers them in ways that are best for us. Just as our earthly parents sometimes say “yes,” sometimes “no,” and sometimes “not now,” our Heavenly Father answers our prayers sometimes with “yes,” sometimes with “no,” and sometimes with “not now.”

2. If it is available in your area, show *Beginning Course Videocassette*, volume 1, segment 16, “The Lost Gold Piece” (53178, 3:08), instead of telling the story about John A. Widtsoe.
3. With the approval of your Primary president, invite a few guests to sing “A Child’s Prayer” (*Children’s Songbook*, p. 12) for the children.
4. Sing or say the words to “Tell Me, Dear Lord” (*Children’s Songbook*, p. 176) or “I Need My Heavenly Father” (*Children’s Songbook*, p. 18).

Tell Me, Dear Lord

Tell me, dear Lord, in thine own way I pray,
 What thou would’st have me say and do today.
 Teach me to know and love thy will, O Lord;
 Help me to understand thy loving word.

I would be guided by thy loving hand;
 Would hear thy voice, obey thy blest command.
 Each moment just to know that thou art near
 Will strength impart and banish every fear.

I Need My Heavenly Father

I need my Heav’nly Father
 To help me ev’ry day.
 He wants me to be happy
 And choose the righteous way.
 He wants me to be happy
 And choose the righteous way.

Lesson
19

Jesus Christ Loves Me

Purpose

To help each child feel that Jesus Christ loves and blesses all children.

Preparation

1. Prayerfully study Matthew 25:34–40, Mark 10:13–16, and 3 Nephi 17.
2. If possible, prepare the following materials for the review game:
 - a. Cut a circle about the size of a dinner plate out of heavy paper. Color one-third of the circle red, one-third yellow, and one-third blue.

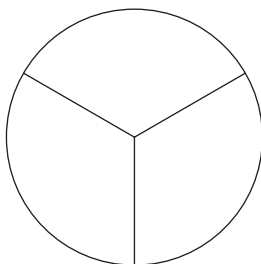

- b. Make twelve colored cards or pieces of paper: four red, four yellow, and four blue (more cards may be needed for a larger class).
 - c. Write a review question such as one of the following on each card:
 - Whom does Jesus Christ love?
 - How do you know Jesus loves you?
 - What did Jesus mean when he said, “Suffer the little children to come unto me”?
 - What did Jesus’ disciples (helpers) try to do when the parents brought their children to see Jesus?
 - How did Jesus show he loved the sick and injured people in America?
 - What did Jesus do after he blessed the children in America?
 - Whom did the parents in America see standing with their children after Jesus blessed them?
 - Why did Jesus bless the children?
 - How can we show our love for Jesus?
 - d. Place the cards in a small box or sack with a question mark drawn on the outside.
 - e. Bring a button or coin that can be dropped onto the colored circle.
 3. Prepare to sing or say the words to both verses of “I Think When I Read That Sweet Story” (*Children’s Songbook*, p. 56). The words to this song are included at the back of the manual.

4. Materials needed:
 - a. A Bible and a Book of Mormon.
 - b. Picture 2-35, Christ and the Children (Gospel Art Picture Kit 216; 62467); picture 2-36, Jesus Blessing the Nephite Children.
5. Make the necessary preparations for any enrichment activities you want to use.

**Suggested
Lesson
Development**

Invite a child to give the opening prayer.

Follow up with the children if you encouraged them to do something during the week.

Jesus Christ Loved and Blessed Little Children

Show the box or sack containing the cards for the review game. Tell the children that at the end of the lesson they will play a game. They will need to listen carefully to the lesson so they will know the answers to the questions in the game.

Attention activity

With the children, sing or say the words to both verses of “I Think When I Read That Sweet Story.” (If the children do not know the song, teach or sing it to them.) Discuss the words of the song and have the children imagine how wonderful it would be to have Jesus Christ put his arms around them or put his hands on their heads.

Scripture story

Display picture 2-35, Christ and the Children, and show the Bible. Explain that the story you are going to tell is found in the Bible. Tell the story found in Mark 10:13–16.

Explain that the disciples were afraid that the children would interrupt and disturb Jesus while he was teaching. But the Savior wanted the children to come near him. Read aloud what Jesus said from Mark 10:14 (starting with *Suffer the little children*). Explain that in this scripture *suffer* means to allow or let. Reread Jesus’ words, substituting the word *let* for *suffer* and leaving out the word *to*: “Let the little children come unto me.”

- What did Jesus do when the children came to him?

Read aloud Mark 10:16. To help the children understand what Jesus did, remind them of the things they learned about the priesthood in lesson 17. Explain that the blessings our fathers or other priesthood holders give us are similar to those that Jesus would give us.

- Why did Jesus want the children to come to him? (Because he loved them and wanted to bless them.)

Point out that even though he was busy teaching the adults, Jesus took time to hold and bless the little children because of his great love for them.

Testimony

Bear your testimony that Jesus loves children. You may want to sing “I Think When I Read That Sweet Story” again with the children.

Scripture story

Display picture 2-36, Jesus Blessing the Nephite Children. Let the children look at the picture and tell you what they see in it. Show the Book of Mormon. Explain that Jesus Christ taught the people in America as well as those in the Holy Land and that his visit to America is described in the Book of Mormon. Tell the story found in 3 Nephi 17.

Explain that when Jesus Christ had finished teaching the people in America, they did not want him to leave. Jesus loved the people very much, so he blessed and healed all the people who were sick or injured or disabled (see 3 Nephi 17:7–10).

Then Jesus asked that all the little children be brought to him. He gathered them around him and said a wonderful prayer (see 3 Nephi 17:11–15).

Tell the children that the Book of Mormon says that the words of this prayer were so great and marvelous that they could not be written down (see 3 Nephi 17:15).

Explain that Jesus then took the children one by one and blessed them and prayed to Heavenly Father for them. As the parents watched, they could see angels with their children (see 3 Nephi 17:21–24). All the people there could feel Jesus' great love for them.

Discussion

- How do you think the children felt when Jesus blessed them and prayed for them?
- How do you feel when you think about Jesus?

Jesus Christ Loves Us

Discussion

Explain that although Jesus Christ is not here in person now, he loves us just as much as he loved the children who were alive when he was on the earth.

- How do we know Jesus loves us? (Answers may include the following: He created the earth for us; he gave us commandments to live by; he gave his life for us; he directs the Church and speaks to us through his prophets; he set a good example for us.)

Child participation

Remind the children that under Heavenly Father's direction, Jesus Christ created the earth and all the plants and animals on it.

Ask each child to name a favorite animal or plant. Remind the children that when they see these things that Jesus created, they can remember that Jesus loves them.

Picture discussion

Show again pictures 2-35, Christ and the Children, and 2-36, Jesus Blessing the Nephite Children.

- Do you think these children are happy that Jesus loves them?
- Are you happy that Jesus loves you?

We Can Show Jesus Christ We Love Him

Teacher presentation

Explain that even though Jesus Christ is not on the earth, we can show him that we are thankful for his love for us and that we love him. Explain that one way we can show Jesus that we love him is by keeping his commandments.

Scripture

Read aloud Matthew 25:40 to tell the children about another way we can show Jesus we love him. (Explain that *the King* is another name for Jesus Christ.) Explain that in this scripture the Savior is telling us that if we are kind to other people, it is like being kind to him. When we treat others kindly, we show Jesus that we love him.

Review game

Play the following game to help the children remember what they have learned from the lesson today. (If it was not possible to prepare all the game materials, adapt the game as necessary, or read the questions listed in the preparation section and have the children take turns answering them.)

Remove the cards from the box or sack and place them face down on the floor or table in piles according to color. Place the colored circle near the cards.

Let a child drop the button or coin onto the circle and then choose a card the same color as the area of the circle on which the button landed. Read the question on the card aloud and have the child answer the question. Give each child a turn.

If the child who drew the card cannot answer the question, you or the other class members may give hints as needed. If time permits, play the game again without giving any hints. Compliment the children for knowing so much about Jesus and his love for them.

Summary

Testimony

Tell the children that Jesus Christ loves each of them and will always love them. Jesus loves being with children and wants to help and bless them. Bear your testimony that Jesus loves and values each child in your class.

Encourage the children to think during the week of all the things that Jesus has done for them because he loves them. You may want to have the children make a list or draw pictures of the things they think of and bring the list or pictures to Primary next week.

Remind the children that they can show Jesus that they love him by obeying the commandments and being kind to others.

Invite a child to give the closing prayer. Suggest that the child express thanks for Jesus Christ and his love.

As the children leave the class, whisper to each child, "Jesus loves you, and I love you too."

Enrichment Activities

Choose from the following activities those that will work best for the children in your class. You can use them in the lesson itself or as a review or summary. For additional guidance, see "Class Time" in "Helps for the Teacher."

1. Bring to class a small mirror attached to a stiff piece of paper. Do not let the children see the mirror. Hold up the back side of the paper and tell your class that you have a secret picture of someone Jesus Christ loves very much. Allow the children to come up one at a time to view the "picture." Ask them to keep the picture a secret until everyone has had a turn to look. Remind the children that Jesus loves each of them.
2. Sing or say the words to "Jesus Loved the Little Children" (*Children's Songbook*, p. 59) or "I Feel My Savior's Love" (*Children's Songbook*, p. 74). The words to these songs are included at the back of the manual.

3. Help the children do the following activity verse:

Jesus Loves All Children

Jesus loves all children (*hold arms outstretched*),

The little ones still small (*use hand to indicate knee-high child*),

The baby in the cradle (*form cradle with arms*),

The ones so big and tall (*raise hands high over head*).

(From *Finger Fun for Little Folk* by Thea Cannon. © 1949 by the Standard Publishing Company, Cincinnati, Ohio. Used by permission.)

Repeat as many times as you want.

4. Make a copy of the drawing of Christ with the children (found at the end of the lesson) for each child. Let the children draw in the faces of the children in the picture and then color their pictures. If you cannot make a copy for each child, make one copy and allow each child in your class to color one of the children in the picture.

Tell the children that if they had been there at the time Jesus Christ lived on earth, he would have taken them into his arms and blessed them too. Remind them that although Jesus is not on the earth right now, he still loves all the people on the earth.



Lesson
20

The Teachings of Jesus Christ Are a Great Treasure

Purpose To strengthen each child's desire to learn more about the teachings of Jesus Christ.

Preparation

1. Prayerfully study Doctrine and Covenants 19:23–24 and Joseph Smith—History 1:14–20. See also Matthew 3:13–16; 4:1–11; 6:9; Mark 10:13–16; 3 Nephi 18:19; and *Gospel Principles* (31110), chapter 10.
2. On a piece of paper, print *The teachings of Jesus Christ are a great treasure*. Fold the paper and put it in a small box or container. Hide the container in the classroom, making sure it can be found easily. (If the children in your class cannot read, hide a picture of Jesus or a copy of the Bible or Book of Mormon instead.)
3. Materials needed:
 - a. A set of scriptures.
 - b. An item of personal value to you.
 - c. A beanbag or other soft object.
 - d. Picture 2-37, Sermon on the Mount (Gospel Art Picture Kit 212; 62166); picture 2-38, The First Vision (Gospel Art Picture Kit 403; 62470); picture 2-39, The Prophet Joseph Smith (Gospel Art Picture Kit 401; 62002); picture of the living prophet (from a Church magazine or the meetinghouse library).
4. Make the necessary preparations for any enrichment activities you want to use.

**Suggested
Lesson
Development**

Invite a child to give the opening prayer.

Follow up with the children if you encouraged them to do something during the week. If you asked the children last week to make lists or pictures of things Jesus has done for them because he loves them, you may want to discuss these lists or pictures for a few minutes.

We Have Many Treasures

Attention activity Show the children the item of personal value you have brought. Tell a few details about the item, such as how it is used, where you got it, or how long you have had it. Point out why it is important to you and how sad you would feel if it were lost, stolen, or broken. Explain that this item is one of your treasures.

- What is a treasure? (Something of great worth.)

Story Tell a story about a child who had a treasured possession. You may want to use the following story:

One of Ruth's schoolmates had a locket that she wore to school every day. Ruth thought it was the most beautiful locket she had ever seen. She wished she could have one like it.

On the morning of Ruth's birthday, her mother handed her a present. It was a small box wrapped with pretty paper and ribbon. Inside Ruth found a beautiful gold locket. It was shaped like a heart, and in the center was a sparkling pink stone. Ruth could hardly believe her eyes.

Discussion

- How do you think Ruth felt about the locket?
- What are some of your treasures? (You may need to suggest some ideas, such as a pet, a favorite toy or book, or an article of clothing.)

The Words of Jesus Christ Are a Great Treasure

Treasure hunt activity

Explain that there is a treasure each of us can have that is greater than (name some of the things the children named as their treasures). This treasure is worth more than any item we can own. This treasure cannot be bought with money, and it cannot break or be stolen. This treasure is so precious that many people are willing to give up everything they own to have it. Some are even willing to give up their lives for it.

Tell the children that to find out what this great treasure is, they are going on a treasure hunt. Explain that you have hidden a treasure in the room. Ask the children to search quietly for the treasure.

When the children have found the box or container, have a child open it and read the message aloud. Then have the children repeat the words of the message with you. (If you hid the picture of Jesus or the book of scripture, explain that this item represents the teachings of Jesus Christ. Tell the children that the teachings of Jesus Christ are a great treasure to us.)

- Why are the teachings of Jesus Christ a great treasure to us?

Emphasize that the teachings of Jesus Christ are a treasure to us because they show us how to be happy by following Heavenly Father and Jesus.

Scripture

Read aloud the first part of Doctrine and Covenants 19:23 (through *words*). Explain that Jesus Christ said this. He wants us to learn about him and his teachings.

We Can Learn the Teachings of Jesus Christ from the Scriptures

Teacher presentation

Show picture 2-37, Sermon on the Mount. Let the children describe what is happening in the picture.

Explain that when the Savior was on the earth, he went from town to town teaching the people how they should live so that they could be happy and someday return to live with Heavenly Father. Many people loved to hear his teachings and followed him wherever he went. Sometimes thousands of people would gather around him to listen and learn.

- How do you think the people felt as they listened to Jesus?

Explain that sometimes Jesus' disciples (helpers) tried to send the people away because Jesus was tired and needed to rest. Jesus always told them to let the people stay to hear his teachings. He wanted all the people to hear and learn so that they could have joy and happiness that would last forever.

Show the set of scriptures. Explain that we can learn many of the teachings of Jesus from the scriptures. Turn to the title page of the New Testament. Explain

that some of the things Jesus taught while he was on the earth are written in the New Testament.

Game

Explain that when Jesus was on the earth he taught many things by example. He wants us to follow his example and do what he did. Play the game “I’m Thinking of . . .” with the children to help them remember some of the things Jesus did and taught.

To play the game, read the following descriptions of incidents in the life of Jesus Christ and ask the accompanying questions one at a time. Have the children raise their hands when they know the answer to a question. Toss a beanbag or other soft object to a child who has a hand raised and ask the child to answer the question. Give each child an opportunity to answer at least one question.

1. I’m thinking of a time when Jesus stood in the river Jordan with John the Baptist (see Matthew 3:13–15).
 - What happened to Jesus in the river Jordan?
 - How was Jesus baptized? (By immersion.)
 - How have we been taught to be baptized? (By immersion.)
2. I’m thinking of someone very special who was there when John the Baptist baptized Jesus. He could not be seen by everyone, but Jesus and John knew he was there (see Matthew 3:16).
 - Who am I thinking of? (The Holy Ghost.)
 - What have we been taught to do to receive the gift of the Holy Ghost? (Be baptized and confirmed.)
3. I’m thinking of a time when Jesus was without food for forty days and forty nights (see Matthew 4:1–11).
 - Who tried to tempt Jesus?
 - What did Jesus do? (He chose the right and commanded Satan to leave.)
 - What have we been taught to do when we are tempted? (Choose the right.)
4. I’m thinking of the time Jesus’ disciples tried to send the children away (see Mark 10:13–16).
 - What did Jesus tell his disciples? (That he wanted the children to stay because he loved them.)
 - Whom does Jesus love? (All of us.)
 - Why does Jesus teach us? (He loves us and wants us to be happy.)
5. I’m thinking of times when Jesus taught the people how to pray (see Matthew 6:9 and 3 Nephi 18:19).
 - Whom did Jesus teach us to pray to?
 - How did Jesus teach us to end our prayers?
 - When should we pray? (Accept all answers and remind the children that we can pray whenever we want to feel close to Heavenly Father, thank him, or ask for his help.)

We Can Learn the Teachings of Jesus Christ from the Living Prophet

Teacher presentation	<p>Explain that we can learn many of the teachings of Jesus Christ by reading the scriptures, but the scriptures do not contain all the teachings of Jesus. Jesus did not stop teaching when he left the earth. Now he teaches us through prophets. Jesus speaks to his prophet and tells him what we need to know. The prophet then gives Jesus' teachings to us.</p>
Scripture story	<p>Show picture 2-38, The First Vision, and have the children help you tell the story found in Joseph Smith—History 1:14–20.</p> <p>Emphasize that Joseph Smith was prepared by Heavenly Father to be a prophet and teach the truth. Heavenly Father and Jesus appeared to Joseph and told him that none of the churches on the earth at that time was true. Later, Joseph helped Jesus bring back the true church.</p> <ul style="list-style-type: none"> • What is the name of the true church of Jesus Christ today? (The Church of Jesus Christ of Latter-day Saints.) <p>Have the children repeat the name together.</p>
Picture discussion	<p>Display picture 2-39, The Prophet Joseph Smith. Explain that Joseph Smith became the first prophet of The Church of Jesus Christ of Latter-day Saints. He helped the early members of the Church know what Jesus wanted them to do.</p> <p>Display the picture of the living prophet next to the picture of Joseph Smith.</p> <ul style="list-style-type: none"> • Who is this? <p>Explain that Jesus Christ speaks to the living prophet just as he spoke to Joseph Smith. When we hear the words of the prophet, we are hearing the teachings of Jesus.</p>
Testimony	<p>Tell the children how wonderful it is to have a prophet. Testify that the current prophet is a true prophet who gives us the Savior's teachings.</p>

The Teachings of Jesus Christ Are Important to Us

Story	<p>Tell the children that sometimes we may forget how wonderful it is to be a member of the Church and have the Savior's teachings. We need to remember what a great treasure the teachings of Jesus are.</p> <p>Tell a story about someone you know who showed the importance of learning the teachings of Jesus Christ and being a member of his church. If you do not know such a story, use the following story:</p> <p>Alette had talked with the missionaries and knew that they taught the teachings of Jesus Christ. She wanted to become a member of The Church of Jesus Christ of Latter-day Saints, but her father didn't want her to be baptized. He didn't understand how much it meant to Alette to learn the teachings of Jesus and become a member of Jesus' church. He asked her to wait. Alette waited, but she continued to go to church and kept praying that one day her father would understand how much becoming a member of the Church meant to her.</p> <p>At Christmastime, Alette's father asked Alette what she wanted for Christmas. She told him that the only thing she wanted was his permission for her to be baptized. Her father decided that if baptism was that important to Alette he would give his permission. Alette was baptized on Christmas Eve. This was the only gift that she received, but it was a great treasure that brought her much joy.</p>
-------	---

- What gift did Alette want?
- Why was this gift so important?

Summary

Discussion

Discuss with the children how grateful we can be for the teachings of Jesus Christ. We can be grateful that—

- We can be baptized as the Savior was.
- We can receive the gift of the Holy Ghost after we are baptized.
- We can pray when we need help.
- We can learn how to choose the right.
- We know that Heavenly Father and Jesus Christ love us.
- We have the scriptures and a prophet to teach us.

Testimony

Bear your testimony that this is Jesus Christ’s true church, and tell the children how grateful you are to be a member and to be able to learn the teachings of Jesus.

Invite each child to stand and express his or her gratitude for the teachings of Jesus. (Do not require any child to do this.) Help the children as needed.

Point out that expressing gratitude for the Savior and his teachings is one way of bearing testimony. Tell the children that they have just shared their testimonies.

Encourage the children to share their testimonies with their families at home. Suggest that when the Spirit prompts them, they can also bear their testimonies in fast and testimony meeting and share what they know about Jesus’ teachings and the true church of Jesus Christ.

Invite a child to give the closing prayer.

Enrichment Activities

Choose from the following activities those that will work best for the children in your class. You can use them in the lesson itself or as a review or summary. For additional guidance, see “Class Time” in “Helps for the Teacher.”

1. Make a copy of the page of drawings at the end of the lesson for each child. Explain that some people keep their favorite possessions in a treasure box like the one in the center of the page of drawings.
 - What things would you put in a treasure box?

Remind the children that some of the most precious things we have are things we can’t put in a treasure box, such as the teachings of Jesus Christ. Discuss the teachings of Jesus represented by the four drawings (baptism, prayer, the sacrament, love).

Have the children draw lines from the drawings of the teachings to the treasure box, and then let them color the drawings.

2. Have the children take turns acting out things that Jesus taught us to do. Let the other children guess what teaching is being acted out. Examples could include praying, being reverent, paying tithing, helping parents, or being kind to brothers and sisters.
3. Sing or say the words to “I’m Trying to Be like Jesus” (*Children’s Songbook*, p. 78), “Jesus Loved the Little Children” (*Children’s Songbook*, p. 59), or “Jesus Wants Me for a Sunbeam” (*Children’s Songbook*, p. 60). The words to these songs are included at the back of the manual.

The Teachings of Jesus Christ Are a Great Treasure

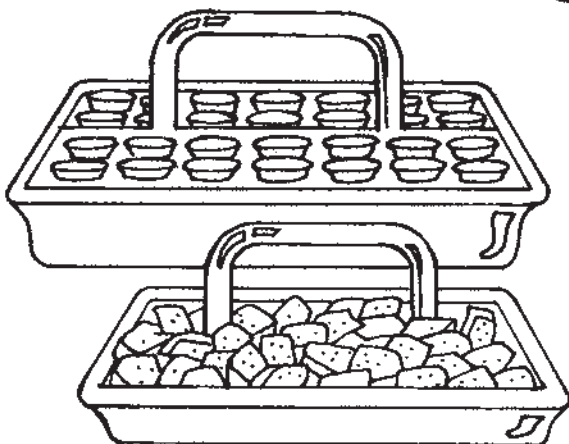
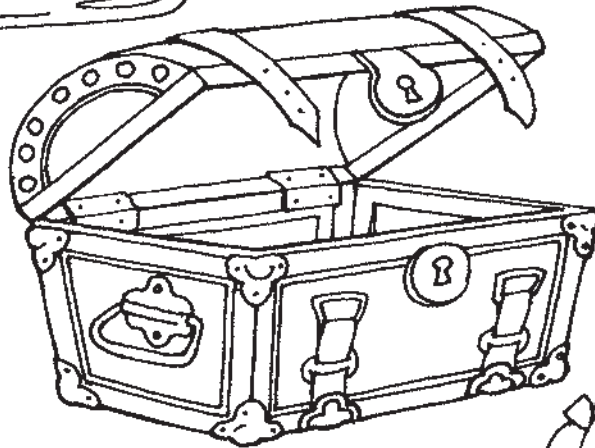

I Can Be Reverent

Lesson
21

Purpose To encourage each child to show reverence for Heavenly Father and Jesus Christ.

Preparation

1. Prayerfully study Luke 2:1–16 and 3 Nephi 17:11–12, 21–24.
2. Prepare cutouts of mouth, eyes, ears, hands and arms, and feet and legs from the pattern at the end of the lesson. Place the cutouts in a bag or other container.
3. Prepare the following wordstrip:

Reverence

4. Prepare to sing or say the words to “Reverently, Quietly” (*Children’s Songbook*, p. 26) and “I Will Try to Be Reverent” (*Children’s Songbook*, p. 28).
 5. Materials needed:
 - a. A Bible and a Book of Mormon.
 - b. Picture 2-36, Jesus Blessing the Nephite Children; picture 2-40, Reverent Child; picture 2-41, The Birth of Jesus (Gospel Art Picture Kit 200; 62116).
 6. Make the necessary preparations for any enrichment activities you want to use.
-

Suggested

Lesson

Development

Follow up with the children if you encouraged them to do something during the week.

Attention activity

Before the opening prayer, sing or say the words to “Reverently, Quietly.”

Rev’reantly, quietly, lovingly we think of thee;
Rev’reantly, quietly, softly sing our melody.
Rev’reantly, quietly, humbly now we pray,
Let thy Holy Spirit dwell in our hearts today.

Display picture 2-40, Reverent Child. Tell the children that the child in the picture is getting ready to talk with Heavenly Father in prayer.

- How do we get ready for prayer? (We fold our arms, close our eyes, and bow our heads.)
- Why do we fold our arms, close our eyes, and bow our heads to get ready for prayer?

Point out that when we do these things, it is easier for us to feel Heavenly Father near us as we pray. Explain that just as it is important to know that our earthly parents are listening when we talk with them, it is important to feel that Heavenly Father is near us when we pray.

Invite a child to give the opening prayer.

After the opening prayer, briefly express your gratitude for a loving Heavenly Father and for the privilege of talking with him in prayer.

Reverence Is a Feeling of Love and Respect

Wordstrip discussion

Display the wordstrip “Reverence” near the picture of the reverent child. Read the word on the wordstrip and have the children repeat it.

- What is reverence?

Emphasize that reverence means more than just being quiet. Reverence is a special feeling of love and respect for Heavenly Father and Jesus Christ.

Ask the children to think of the feelings they have when their parents help them pray or read stories about Jesus to them, or when they see and hear the beautiful creations of Heavenly Father and Jesus Christ. Explain that these warm, peaceful feelings are feelings of reverence. These feelings help us know that Heavenly Father’s spirit is near.

Picture discussion

Show picture 2-36, Jesus Blessing the Nephite Children. Have the children tell you about the picture (see 3 Nephi 17:11–12, 21–24).

- How do you think the Nephite children felt about Jesus Christ?

Show picture 2-41, The Birth of Jesus, and ask the children to tell the story of Jesus’ birth (see Luke 2:1–16). Have them look carefully at the people in the picture.

- How do you think the people felt when they saw baby Jesus?
- How do you think you would have felt if you had seen baby Jesus?

Explain that when we think of Heavenly Father and Jesus in a loving way we are reverent.

We Show Reverence by Our Actions

Discussion

- How do we show our feelings of reverence (love and respect) for Heavenly Father and Jesus Christ?

Explain that it is important to have feelings of reverence no matter where we are, but we should especially remember to be reverent at church. The meetinghouse is Heavenly Father’s house, and when we are reverent in Heavenly Father’s house, Heavenly Father knows that we love him.

Song

With the children, sing or say the words to “I Will Try to Be Reverent.”

I love my Heav’nly Father,
And I will try to be
Rev’rent when I’m in his house.
Then he’ll be near to me.

Activity

Show the bag or container with the cutouts in it. One at a time, invite each child to take a cutout from the bag, show the cutout to the other children, and ask, “What should you do with your (item shown in cutout) to show reverence in Heavenly Father’s house?”

Possible answers:

Mouth—Speak quietly, smile, sing songs, pray, keep closed when someone else is talking.

Eyes—Look at the teacher or speaker, close during the prayer.
 Hands and arms—Hold still, raise to answer a question, fold during prayer.
 Feet and legs—Walk quietly, hold still.
 Ears—Listen to what is being said.

Activity Help the children say the words and do the actions to the following rest activity:

I'm always reverent
 From my head (*put hands on head*)
 To my toes (*touch toes*).
 When I walk (*walk quietly in place*),
 I step quietly as I go.
 When I speak,
 Words come softly (*put finger to lips*),
 Not loud and bold (*turn head from side to side*).
 When I listen (*cup hand to ear*),
 Lips stay shut (*zip lips*)
 And my arms I fold (*fold arms*).
 When I pray,
 My head I bow (*bow head*)
 And my eyes I close (*close eyes*).
 I'm always reverent
 From my head (*put hands on head*)
 To my toes (*touch toes*).
 (Adapted from Diana Eckersell Janson, "I'm Always Reverent," *Friend*,
 Sept. 1993, p. 32.)

We Can Help Others Be Reverent

Teacher presentation Remind the children that their actions affect those around them. This is another good reason to be reverent in church.

- How does it make you feel when someone near you is noisy in Primary?

Point out that if someone around us is noisy, it is hard for us to think about Heavenly Father and Jesus Christ. Similarly, when we make noise or do other things that are not reverent, we make it hard for other people to be reverent. Encourage the children to act in ways that will help themselves and others to be reverent.

Story Tell a story about a child you know who helped a friend be more reverent, or tell the following story:

Patty was a very happy girl. She loved to smile, laugh, and sing. But most of all she loved to talk. She always had lots of things to say and would talk to anyone who would listen to her. Patty's best friend was Mary Jo, who liked to talk almost as much as Patty did.

One Sunday Patty visited Mary Jo's Primary class. During the opening exercises, Patty started to tell Mary Jo about her new shoes, but Mary Jo just shook her head and motioned for Patty to be quiet.

Since no one would listen to her, Patty stopped talking and soon became interested in the story that the teacher was telling. She learned about the Savior and enjoyed Primary.

As the girls left, their teacher thanked them for being reverent in class. After class, Mary Jo explained to Patty why she hadn't talked to her during Primary. Mary Jo said that she loved Heavenly Father and Jesus, and so she always tried to be reverent in church.

Discussion

- Why did Mary Jo want to be reverent in Primary?
- How did Mary Jo help Patty be reverent?
- How can you help others be reverent?

Summary

Testimony

Testify to the children that being reverent will help them learn more about Heavenly Father and Jesus Christ and feel love for them. You may want to share a personal experience when you felt a special reverent feeling for Heavenly Father and Jesus.

Allow the children to express their feelings of love and respect for Heavenly Father and Jesus.

Encourage the children to be reverent as they go to other meetings or as they leave the meetinghouse after Primary.

Invite a child to give the closing prayer.

Enrichment Activities

Choose from the following activities those that will work best for the children in your class. You can use them in the lesson itself or as a review or summary. For additional guidance, see "Class Time" in "Helps for the Teacher."

1. Help the children do the following finger play:

Quiet as a flake of snow (*reach arms up high and bring them down, fluttering fingers*),

Quiet as the flowers grow (*make a fist and then slowly open fingers like a budding flower*),

Quiet as a butterfly (*link thumbs and wave fingers like wings*),

Softly, softly passing by.

That's how quiet I will be (*place one hand over heart*)

When I come to Primary (*fold arms together*).

2. Toss a beanbag or other soft object to a child and ask the child to tell one way he or she can show reverence (answers may include sitting up straight, listening, thinking about Jesus, raising a hand, walking quietly, showing respect for others, and folding arms). Then have the child toss the beanbag back to you. Continue until each child has had several turns. Encourage the children to think of many ways to show reverence.

3. Help the children role-play several situations involving reverence. Use the following ideas or some of your own:

- You want to tell your Primary teacher something during the lesson. How can you do this reverently?
- You don't know the song your class is singing. What can you do to show reverence?

- Your little brother talks to you during the sacrament. What can you do to help him be reverent?
- You walk into a room while people are praying. How can you show reverence?

4. Help the children do the following finger play:

Here is the church (*clasp fingers and close hands with fingers inside*).
 Here is the steeple (*extend index fingers to make a steeple*).
 Open the door (*open hands, keeping fingers clasped*),
 And see all the people (*wiggle fingers*).
 Shut the door (*again close hands with fingers inside*)
 And hear them pray.
 Open the door (*open hands, keeping fingers clasped*),
 And they all go away (*separate hands*).

After doing this finger play, tell a story about a child who uses this finger play during sacrament meeting. When the child looks around and notices that everyone else is sitting quietly, he or she decides to make the finger people reverent also and lays them quietly in his or her lap.

5. Sing or say the words to “Reverence Is Love” (*Children’s Songbook*, p. 31) or “Father, I Will Reverent Be” (*Children’s Songbook*, p. 29).

Reverence Is Love

Rev’rence is more than just quietly sitting:
 It’s thinking of Father above,
 A feeling I get when I think of his blessings.
 I’m rev’rent, for rev’rence is love.
 When I’m rev’rent, it shows in my words and my deeds.
 The pathway to follow is clear.
 And when I am rev’rent, I know in my heart
 Heav’nly Father and Jesus are near.
 (© 1987 by Maggie Olauson. Used by permission.)

Father, I Will Reverent Be

Father, I will rev’rent be
 And in thy house walk quietly;
 Fold my arms and bow my head
 And close my eyes when prayers are said;
 Listen to the words I hear,
 For in thy house I feel thee near.
 May my thoughts more perfect be,
 That I may speak more rev’rently.
 Father, I will rev’rent be
 And in thy house walk quietly.



Blessed Are the Peacemakers

Lesson
22

Purpose To encourage each child to be a peacemaker at home.

Preparation

1. Prayerfully study Matthew 5:1–12 (or 3 Nephi 12:1–12) and 7:1–5, 12 (or 3 Nephi 14:1–5, 12).
2. Make a larger copy of the following illustration for each child in the class and for yourself (save yours to use with lesson 26).

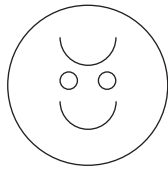

3. If possible, obtain several pictures of families doing enjoyable things together.
4. Write *Blessed Are the Peacemakers* at the top of a piece of paper for each child in the class.
5. Prepare to sing or say the words to “Smiles” (*Children’s Songbook*, p. 267). The words to this song are included at the back of the manual.
6. Materials needed:
 - a. A Bible or Book of Mormon.
 - b. Pencils or crayons.
 - c. CTR chart (see lesson 1).
 - d. Picture 2-37, Sermon on the Mount (Gospel Art Picture Kit 212; 62166); picture 2-42, Family Fun.
7. Make the necessary preparations for any enrichment activities you want to use.

**Suggested
Lesson
Development**

Invite a child to give the opening prayer.

Follow up with the children if you encouraged them to do something during the week.

Feelings in Our Homes Can Be Happy or Sad

Attention activity Give each child a paper face. Have the children sing or say the words to “Smiles” with you, turning the faces to frowns or smiles as suggested by the words.

Discussion Display picture 2-42, Family Fun, and any other pictures you obtained of family members doing enjoyable things together. Ask the children to turn their paper faces to show how they think the people in the pictures feel.

- Why do you think all these people feel happy?

Ask the children to turn the faces to show how they think family members would feel if they were arguing and fighting.

- Why does arguing and fighting make family members sad?

Activity

Have the children turn their paper faces to the sad face and each tell something that would make a family sad. Then have the children turn their paper faces to the happy face and tell things that make their families happy.

- Do you like it better when your family is happy or when your family is sad?

Collect the faces so they won't distract the children. Return them at the end of class so the children can take them home.

Jesus Christ Taught Us to Be Peacemakers

Discussion

Display picture 2-37, Sermon on the Mount, and have the children tell you what they know about the picture. Explain that Jesus Christ went up on a hillside and taught the people many important things, including some ways to make our homes happy.

Read aloud Matthew 5:9 (or 3 Nephi 12:9). Explain that Jesus taught the people to be peacemakers. Have the children repeat the word *peacemaker* with you.

- What is a peacemaker?

Explain that a peacemaker is someone who helps others to be happy instead of angry. *Peace* means calmness and happiness, so a peacemaker makes a home a calm and happy place to be.

Explain that Heavenly Father and Jesus Christ are peacemakers, and each of us can also be a peacemaker. Jesus has told us how.

Read aloud Matthew 7:12 (or 3 Nephi 14:12). Help the children understand that they should treat others the way they themselves like to be treated. Then they will be peacemakers and will help bring a happy feeling into their homes.

Dramatization activity

Describe some situations to the children and help them think of and act out the way a peacemaker would act in each situation. Help the children think of ways everyone involved in the situation can be happy. Use the situations below or create some of your own:

1. You are quietly looking at a book when your sister comes over and grabs the book out of your hands because she wants to read it.
 - How would you like to be treated?
 - What will you say or do if you are a peacemaker?
2. You go to the kitchen to get one of your favorite cookies. Your brother runs to the cookie jar, takes the last cookie, and eats it. You are angry.
 - How would you like to be treated?
 - What will you say or do if you are a peacemaker?
3. You and your friend are drawing pictures. She teases you for coloring a tree purple. Your feelings are hurt, and you think of a mean name to call her.
 - How would you like to be treated?
 - What will you say or do if you are a peacemaker?

Scripture	Read again or paraphrase Matthew 7:12 (or 3 Nephi 14:12) for the class.
CTR chart	Display the CTR chart. Tell the children that when they treat others the way they would like to be treated, they are following Jesus Christ and choosing the right. Have the children repeat the words on the chart with you.

We Can All Be Peacemakers

Story	<p>Tell the following story about peacemakers in your own words:</p> <p>A bishop asked several young people to help him. For one month he wanted the young people to be peacemakers in their homes but not tell anyone what they were doing. He told them to be kind and thoughtful and to be good examples. He asked them to help stop quarrels and find ways to show love for their family members. The young people were to come back to the bishop in one month and tell what happened.</p> <p>In one month they all met again and told what they had done. All the young people said that their homes had become happier places to live because of their efforts to be peacemakers. (See Franklin D. Richards, in Conference Report, Oct. 1974, p. 153; or <i>Ensign</i>, Nov. 1974, p. 106.)</p>
Discussion	<ul style="list-style-type: none"> • What did the bishop ask the young people to do? • What happened when they did this? • How can you be a peacemaker in your own home?
Art activity	<p>Give each child a piece of paper on which you have written <i>Blessed Are the Peacemakers</i>. Read aloud the words at the top of the paper and have the children repeat them together. Give the children pencils or crayons and let them draw pictures of their families being happy.</p> <p>Encourage the children to hang their pictures somewhere at home to remind them to be peacemakers.</p>

Summary

Song	Pass out the paper faces and sing or say the words to “Smiles” again. Remind the children that by being peacemakers they can help turn frowns into smiles.
Testimony	<p>Testify that Heavenly Father and Jesus Christ want us to be peacemakers. Remind the children that when they try to be peacemakers at home, they and their families can be happier.</p> <p>Encourage each child to try to be a peacemaker at home during the coming week. Ask the children to be prepared to tell about their experiences in class next week.</p> <p>Invite a child to give the closing prayer. Suggest that the child ask Heavenly Father to help the class members be peacemakers in their homes.</p>

Enrichment Activities

Choose from the following activities those that will work best for the children in your class. You can use them in the lesson itself or as a review or summary. For additional guidance, see “Class Time” in “Helps for the Teacher.”

1. Show picture 2-3, Jesus the Christ, or another picture of Jesus. Ask the children to pretend that Jesus Christ is coming to visit their homes. Ask them to think about how excited they would feel to have Jesus visit them.

- What will you do to get ready?
- How will you act when Jesus comes?

Let the children act out some things they would do if Jesus came to visit them. Explain that if Jesus were in their home they would want to try very hard to be a peacemaker by sharing, being kind to one another, and not fighting. Then they could enjoy the good feeling that Jesus brought to their home.

Tell the children that one way they can know how to be a peacemaker is to think of how they would behave if Jesus were visiting their home.

2. Sing or say the words to “A Happy Family” (*Children’s Songbook*, p. 198). The words to this song are included at the back of the manual.

Remind the children that when they are peacemakers, they help make their families happy.

3. Sing or say the words to “If You’re Happy” (*Children’s Songbook*, p. 266), replacing *clap your hands* with actions the children suggest.

If you’re happy and you know it, clap your hands.
If you’re happy and you know it, clap your hands.
If you’re happy and you know it,
Then your face will surely show it.
If you’re happy and you know it, clap your hands.

4. To show the children that they can control their reactions to the actions of others, have two children stand facing each other. Have one child try to keep a straight face (show no facial expression) while the other child tries to make him or her smile, laugh, or show some other facial expression. Let all the children who want to participate take turns trying this activity.

Help the children understand that they should try to control their own reactions when someone else does something that takes away from peace at home. For example, when a brother or sister yells at them, their first thought might be to yell back, but if they are trying to be peacemakers, they can find a better way to react.

Jesus Christ Is the Good Shepherd

Lesson
23

Purpose To help each child understand that every person is important to Jesus Christ.

Preparation

1. Prayerfully study Luke 15:1–7 and John 10:1–18.
2. Paste picture 2-44, The Lost Sheep, onto heavy paper. Then cut it into puzzle pieces, making sure the entire sheep is on one piece of the puzzle. (Save these puzzle pieces for use with future classes.) Before class, hide the puzzle piece with the sheep on it somewhere in the classroom where it will not be easily found.
3. Using the pattern at the end of the lesson, make a copy or tracing of a lamb for each person in the class, including yourself. Write each person's name on a lamb.
4. Materials needed:
 - a. A Bible.
 - b. Picture 2-43, A Shepherd.
5. Make the necessary preparations for any enrichment activities you want to use.

**Suggested
Lesson
Development**

Invite a child to give the opening prayer.

Follow up with the children if you encouraged them to do something during the week. You may want to have the children report on their experiences in trying to be peacemakers in their homes.

Shepherds Care for Their Sheep

Attention activity Show picture 2-43, A Shepherd.

- Who is this man?

Explain that the man in the picture is a shepherd, like those who lived when Jesus Christ was on the earth.

- What is he wearing?

Point out the shepherd's cloak. Explain that this cloak, made of sheepskin or wool, protects the shepherd from the hot desert sun and the cold nights. The covering on his head also protects him from the sun. The shepherd carries a container of water and a stick that is called a staff.

- What does a shepherd do?

Explain that a shepherd takes care of sheep. The sheep know the shepherd's voice, and they follow where he leads them. Point out that the shepherd does not herd the sheep from behind. He walks in front of them to show them where to go. The shepherd leads his sheep to green pastures where they find good

grass to eat. He also leads them to water. At night he leads them back to the sheepfold, which is a walled or fenced area or a cave where the sheep are safe from wild animals and thieves. The shepherd stands guard at the entrance to the sheepfold and protects his sheep. The shepherd counts his sheep to make sure that not one is lost.

Each Lamb Is Important to Its Shepherd

Story

Explain that all shepherds, whether in Jesus' time or today, care about and protect their sheep. Tell the following story in your own words:

Carrie and Jimmy lived on a farm. Their family raised sheep, and Carrie and Jimmy had their own little flock of lambs. They took good care of their lambs. They were good shepherds.

One night there was a big storm. The wind blew down part of the fence in the corral where Carrie and Jimmy's lambs were kept. A crash of thunder frightened the lambs, and they all ran out of the corral.

When morning came Carrie and Jimmy ran outside to care for their lambs. But the lambs were nowhere to be found. Carrie and Jimmy were worried. They started to follow the lambs' tracks on the damp ground. Soon Carrie and Jimmy had found all but one of their lambs.

- What do you think Carrie and Jimmy did?

Carrie and Jimmy herded the lambs back into the corral and went looking for the lost lamb. They noticed that one set of tracks went in a different direction than the other tracks. They followed this set of tracks.

Carrie and Jimmy finally found the lamb. Its leg was caught in a hole, and it was tired and weak. They gently carried the lamb home, and Jimmy held it while Carrie cleaned the scrapes on its leg. Carrie and Jimmy were very happy to have found all their lambs.

- Why did Carrie and Jimmy continue looking for the last lamb after they had found the others?

Puzzle activity

Place the pieces of the puzzle that you have made on the floor or on a table, and help the children put the puzzle together.

When the children realize that one piece is missing, point out that the missing piece has a picture of a sheep on it.

- What does a good shepherd do when a sheep is lost?

Scripture story

Hold up the Bible and tell the children that in the Bible Jesus Christ tells us what a good shepherd does when a sheep is lost. Explain that while Jesus was on the earth he often taught people by telling stories. One of his stories was about a shepherd and his lost sheep. Read aloud Luke 15:4.

- What does the Bible say a good shepherd should do?

Dramatization activity

Ask the children to pretend they are shepherds. Have them each pretend to put on a cloak and carry a staff, and then have them look for the lost puzzle piece with the sheep on it. When the puzzle piece is found, praise all the shepherds and gather them to complete the puzzle.

Ask the children how they felt when the piece was found.

Scripture	<p>Tell how the shepherd in the parable felt when he found his sheep, as told in Luke 15:5–6. Compare what the children experienced with what Jesus said a good shepherd would do and feel.</p> <p>Jesus Christ Is the Good Shepherd and We Are His Lambs</p>
Scripture discussion	<p>Read aloud John 10:14.</p> <ul style="list-style-type: none"> • Who is the good shepherd in this scripture? <p>Explain that the words in the scripture are Jesus Christ's words. He is the Good Shepherd.</p> <ul style="list-style-type: none"> • Who are the sheep in Jesus' fold? (Explain that <i>fold</i> here means a group of sheep.) <p>Help the children understand that they are some of the sheep in Jesus' fold. Explain that the Savior compared himself to a shepherd because he loves and cares for each of us like a shepherd cares for the sheep. He wants each of us to be safe and happy. Just as a shepherd knows each sheep, Jesus knows each one of us. We are all important to him.</p>
Activity	<p>Show the paper lambs with the children's names on them. Hold up a lamb and say, "(Child's name) is one of the lambs in Jesus' fold." Then display the lamb on the table or floor. Continue this activity until you have mentioned everyone, including yourself. When you come to a child who is not present, say something like this: "(Child's name) is one of the lambs in Jesus' fold, and Jesus knows she isn't at Primary today. He wants all his lambs to be here."</p> <p>After this activity, pick up all the lambs and have the children count them together. Point out that this is how many children should be in the class or how many lambs should be in the fold. Compare this number to the number of children present in the class today. Tell the children that you hope they will all come every week unless they are sick or out of town because you want to help take care of them and teach them. Emphasize how important it is to Jesus that all his lambs come to Primary.</p> <p>Suggest that the children be shepherds and find the lost lambs—the children who are not attending Primary today—and help lead them back to Primary.</p> <p>Summary</p>
Testimony	<p>Bear testimony that each child is important to Jesus Christ and that Jesus loves and cares about each one of them.</p> <p>Give each child the lamb with his or her name on it. Encourage the children to take their lambs home and share what they have learned about shepherds and the Good Shepherd with their families.</p> <p>Invite a child to give the closing prayer.</p>

Enrichment Activities

Choose from the following activities those that will work best for the children in your class. You can use them in the lesson itself or as a review or summary. For additional guidance, see “Class Time” in “Helps for the Teacher.”

1. Have the children write a note or draw a picture to be given to a child who was not at Primary today. It might say something like, “We missed you at Primary” or “Come join us at Primary.”
2. Let the children color their lambs or glue cotton balls to the lambs to make them fluffy.
3. Help the children do the activity verse “Jesus Loves All Children”:
*Jesus loves all children (hold arms outstretched),
The little ones still small (use hand to indicate knee-high child),
The baby in the cradle (form cradle with arms),
The ones so big and tall (raise hands high over head).*
(From *Finger Fun for Little Folk* by Thea Cannon. © 1949 by the Standard Publishing Company, Cincinnati, Ohio. Used by permission.)
4. Sing or say the words to “Jesus Loved the Little Children” (*Children’s Songbook*, p. 59) or “I Feel My Savior’s Love” (*Children’s Songbook*, p. 74). The words to these songs are included at the back of the manual.
5. Sing or say the words to the first verse of “Dear to the Heart of the Shepherd” (*Hymns*, no. 221).

Dear to the heart of the Shepherd,
Dear are the sheep of his fold;
Dear is the love that he gives them,
Dearer than silver or gold.
Dear to the heart of the Shepherd,
Dear are his “other” lost sheep;
Over the mountains he follows,
Over the waters so deep.
Out in the desert they wander,
Hungry and helpless and cold;
Off to the rescue he hastens,
Bringing them back to the fold.

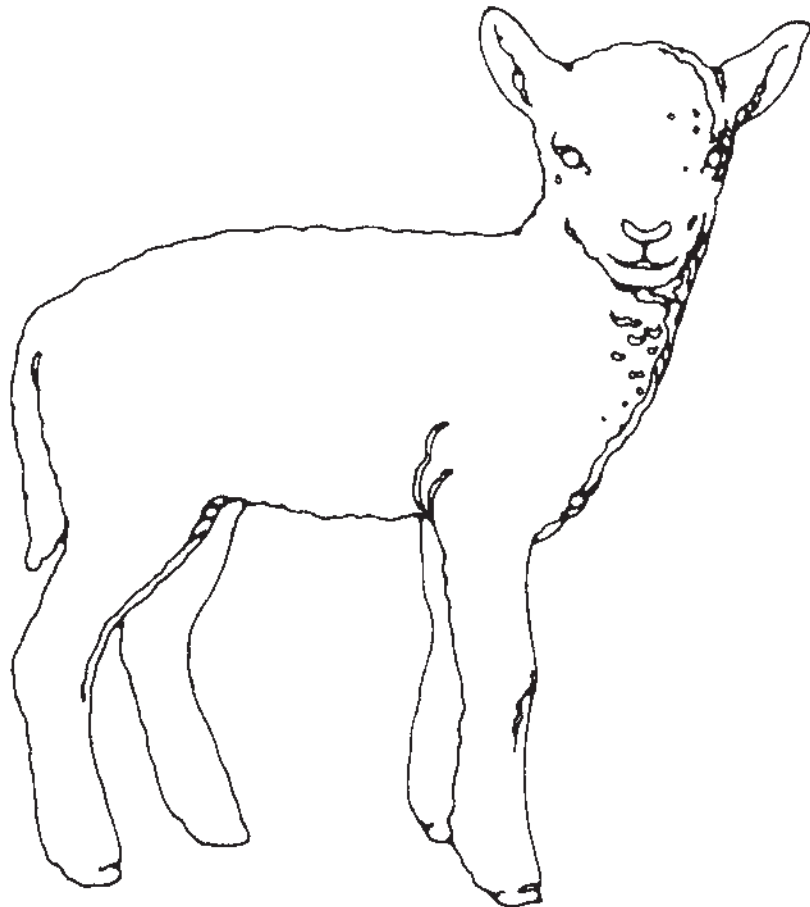
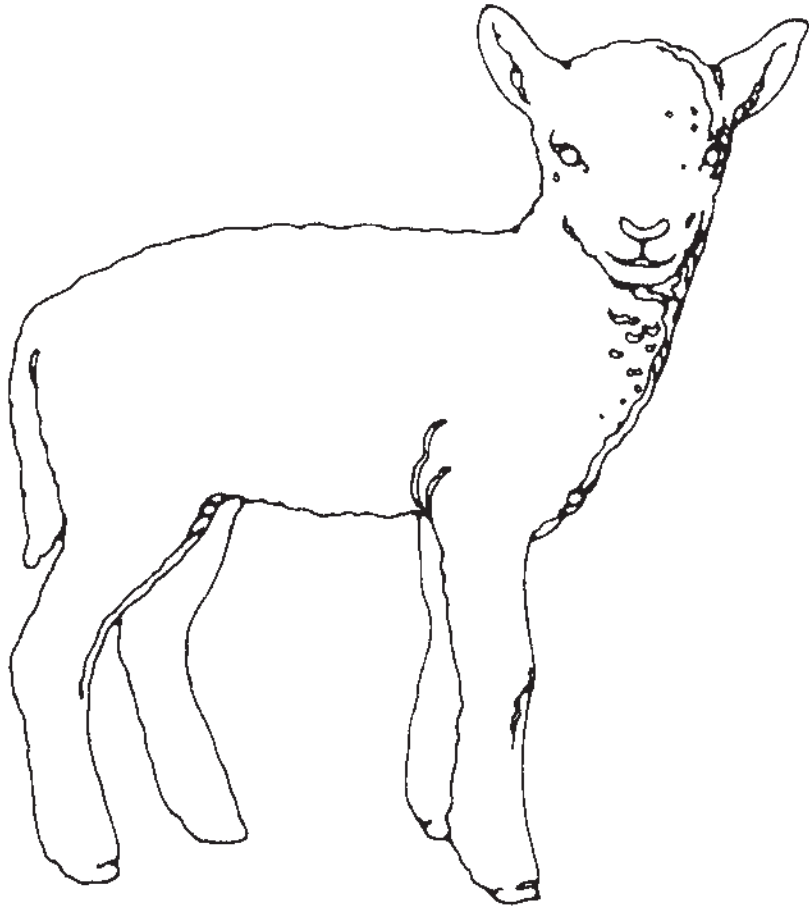

Purpose	To encourage each child to feel and express gratitude to Heavenly Father.
----------------	---

Preparation	<ol style="list-style-type: none">1. Prayerfully study Luke 17:11–19 and 1 Thessalonians 5:18.2. Prepare to sing or say the words to “Children All Over the World” (<i>Children’s Songbook</i>, p. 16).3. Materials needed:<ol style="list-style-type: none">a. A Bible.b. A small cup, a large spoon, a container of water, and a pan or flat dish big enough to hold the cup and the container of water.c. Crayons and paper for each child.d. Chalkboard, chalk, and eraser.e. Picture 2-45, Ten Lepers (Gospel Art Picture Kit 221; 62150).4. Make the necessary preparations for any enrichment activities you want to use.
--------------------	---

**Suggested
Lesson
Development**

Invite a child to give the opening prayer.

Follow up with the children if you encouraged them to do something during the week.

We Have Been Given Many Blessings

Attention activity Display the empty cup, the spoon, and the container of water. Ask the children to think of the many blessings Heavenly Father has given them, and explain that each time they name a blessing they may take a spoonful of water from the container and put it into the cup.

Place the cup and the container of water in the pan or dish to catch spills, and place the pan or dish on a flat surface such as the table or floor.

You may want to use the following questions to help the children think of their blessings:

- What are some of the beautiful creations Heavenly Father has given us?
- Who are some special people he has blessed us with?
- What things can our wonderful bodies do?

Have the children take turns naming blessings and putting spoonfuls of water in the cup until the cup is filled to overflowing. Explain that Heavenly Father loves us and has given us many blessings. When we think of these blessings, we are thankful and filled with love for Heavenly Father. Heavenly Father has given us so many blessings that we can overflow with love, just like the cup overflowed with water.

We Should Feel and Show Gratitude

Story and discussion

Tell the following story in your own words:

Laura's birthday was coming up, and Laura's grandmother wanted to make her a special gift. Although Grandma's eyesight was failing and sewing by hand was becoming difficult for her, she decided to make Laura a doll. She spent many hours making a doll with braided hair, an embroidered face, and a beautiful lace dress. On Laura's birthday, Grandma wrapped up the doll and took it to Laura.

Tell the children that you are going to tell them two different endings to the story. Ask them to listen carefully and decide which ending is better.

Ending 1

Laura was excited about her birthday and her gifts. She opened all of them quickly. When she came to Grandma's gift, she opened the package, looked at the doll for just a moment, and then tossed the doll aside and reached for the next gift.

- Do you think Laura liked the doll?
- How do you think Laura's grandmother felt?

Ending 2

Laura was excited about her birthday and her gifts, and she opened each gift carefully. As she opened the package from her grandmother, a warm feeling came over her. She gently touched the doll's carefully braided hair, embroidered face, and lacy dress. Then she ran to her grandmother and hugged her tightly. "Oh, thank you, Grandma," she whispered.

- Do you think Laura liked the doll?
- How do you think Laura's grandmother felt?
- In which ending did Laura show love for her grandmother and appreciation for the many hours her grandmother spent making the doll?

Discussion

Write the word *gratitude* on the chalkboard and say it with the children. Explain that gratitude is a feeling of being thankful. When we are thankful for something someone has done for us or given us, we should show our gratitude.

- How did Laura show her gratitude for the doll in the second ending to the story?

Explain that when we feel and show gratitude, we are happy, and the person we thank is also happy. Discuss the feelings of love and happiness that Laura and her grandmother shared because Laura felt and showed gratitude.

Scripture story and discussion

Show picture 2-45, Ten Lepers, and tell the story found in Luke 17:11–19.

Explain that leprosy is a skin disease that destroys parts of the body. People were afraid of lepers because they thought they would catch the lepers' disease, so lepers had to stay away from their families and friends.

Emphasize that when the lepers did what Jesus Christ told them to do, they were healed of their leprosy. They were able to live with their families and friends again.

- How would you feel if Jesus Christ had done this great miracle for you?

Have the children listen as you read aloud Luke 17:15–17 to find out how the lepers showed their gratitude.

- How many lepers were healed?

Have the children hold up ten fingers.

- How many lepers returned to thank Jesus?

Have the children put nine fingers down. Emphasize that only one man out of ten showed his gratitude to Jesus for this great miracle.

- Why do you think only one of the men returned to thank Jesus?

We Can Thank Heavenly Father in Our Prayers

Scripture
discussion

Read aloud 1 Thessalonians 5:18 to the children.

- What does this scripture say we should do?

Remind the children that Heavenly Father has given each of us many blessings. He is happy when we thank him for our blessings.

- How can we thank Heavenly Father for the many blessings he gives us?

Song

Sing or say the words to “Children All Over the World.”

All over the world at the end of day,
Heav’nly Father’s children kneel down and pray,
Each saying thank you in his own special way,
Saying thank you, thank you in his own special way.
“Gracias.” “Mālō.” “Wir danken dir.”
All over the world tender voices hear.
Some say “tak,” others “merci,”
“Kansha shimasu,” we thank thee.
Our Heavenly Father hears them;
He understands each tongue.
Our Heav’nly Father knows them;
He loves them, loves them, ev’ry one.

Discussion

- When do we pray?

Discuss the various times we offer prayer and the things we can thank Heavenly Father for in each prayer. For example, when we pray before meals, we can thank Heavenly Father for giving us food to eat. Emphasize the importance of remembering to thank Heavenly Father in our prayers.

We Can Show Our Gratitude through Our Actions

Discussion
activity

Explain that we can also show our gratitude through our actions. When we obey the commandments and do the things Heavenly Father has asked us to do, we show that we love Heavenly Father and appreciate what he has given us.

Describe some situations in which a person could show gratitude by his or her actions. Ask the children to tell how each person could show gratitude by being obedient to Heavenly Father. Use the following situations or create some of your own:

1. Mary is the oldest child in her family. She has two younger brothers and two younger sisters. She is thankful for her family.
 - How could Mary show Heavenly Father that she is thankful for her family? (By showing love and kindness to each family member.)
2. John ran errands for his neighbor to earn extra money. He is thankful that Heavenly Father helped him find the job.
 - How could John show his gratitude to Heavenly Father? (By paying tithing on the money he earned.)
3. Kim loves to play soccer. She is thankful that Heavenly Father has given her a strong, healthy body.
 - What could Kim do to show Heavenly Father her gratitude for her body? (Obey the Word of Wisdom; eat good foods and take care of her body.)
4. The missionaries taught Lee's family the gospel, and the family was baptized. Lee is very thankful for the missionaries.
 - What could Lee do to show his gratitude to Heavenly Father? (Prepare to serve a mission when he is older.)
5. Anna looks forward to each Sunday. She loves going to Primary. She is thankful for the Church.
 - What could Anna do to show Heavenly Father how thankful she is? (Attend all her meetings; be reverent at church.)

Summary

Art activity

Give the children paper and crayons and have them draw pictures of things they are thankful for. Invite the children to tell the other members of the class about their pictures.

Testimony

Tell the children how thankful you are to be their teacher. Explain how you show Heavenly Father your gratitude for this blessing. Testify that Heavenly Father has given us many blessings and he is happy when we feel gratitude and thank him for our blessings.

Encourage the children to remember to thank Heavenly Father for their blessings through their prayers and their actions during the coming week.

As the children prepare for the closing prayer, ask them what things they could thank Heavenly Father for in the class prayer. Invite a child to give the closing prayer.

Enrichment Activities

Choose from the following activities those that will work best for the children in your class. You can use them in the lesson itself or as a review or summary. For additional guidance, see "Class Time" in "Helps for the Teacher."

1. Ask the children to tell what their favorite animals, vegetables, and fruits are. Emphasize that Heavenly Father planned and Jesus Christ created all these things for us to enjoy. We should remember to show our gratitude for these things.

2. Show some pictures of animals. Discuss the care animals need, such as water, food, grooming, and love. Explain that taking care of animals and other creations shows Heavenly Father we are grateful for them.
3. If it is available, show the segment "Reverence for God and Creation" on *Family Home Evening Video Supplement 2* (53277). Emphasize that Heavenly Father planned and Jesus Christ created everything we need to live and be happy. We should show them how thankful we are for our many blessings.
4. Sing or say the words to "Thanks to Our Father" (*Children's Songbook*, p. 20), "Can a Little Child like Me?" (*Children's Songbook*, p. 9), or "I Thank Thee, Dear Father" (*Children's Songbook*, p. 7). The words to "I Thank Thee, Dear Father" are included at the back of the manual.

Tell the children that we can also thank Heavenly Father through singing. Explain that songs of praise to Heavenly Father are like prayers (see D&C 25:12).

Thanks to Our Father

Thanks to our Father we will bring,
For he gives us ev'rything.

Eyes and ears and hands and feet,
Clothes to wear, and food to eat;

Father, mother, baby small,
Heav'nly Father gives us all.

Thanks to our Father we will bring,
For he gives us ev'rything.

Can a Little Child like Me?

Can a little child like me
Thank the Father fittingly?
Yes, oh yes! Be good and true,
Patient, kind in all you do!
Love the Lord and do your part;
Learn to say with all your heart:
Father, we thank thee!
Father, we thank thee!
Father in Heaven, we thank thee!

Remember to Say “Thank You”

Lesson
25

Purpose To encourage each child to remember to thank others for their acts of kindness and love.

Preparation 1. Prayerfully study Luke 17:11–19 and Doctrine and Covenants 78:19.
2. Prepare a thank-you note as shown:

Thank you. I'm glad you're my teacher.
Love,
Rebecca

3. Materials needed:
- a. A Bible and a Doctrine and Covenants.
 - b. Pencils or crayons and a piece of paper for each child.
 - c. Chalkboard, chalk, and eraser.
 - d. Picture 2-45, Ten Lepers (Gospel Art Picture Kit 221; 62150).
4. Make the necessary preparations for any enrichment activities you want to use.

Note: Make a special effort during this lesson to say “thank you” to the children when it is appropriate.

**Suggested
Lesson
Development**

Invite a child to give the opening prayer.

Follow up with the children if you encouraged them to do something during the week.

We Can Use Two Special Words

Attention activity

Tell the children that there are two special words you want to share with all of them. These special words can be used by everyone, but they are not used often enough. Whisper “thank you” to one of the children, and have him or her whisper “thank you” to another child. Continue until every child has heard the words. Have the last child stand up and say the words out loud.

- When do we say “thank you”?

Explain that we all like others to do kind things for us, but sometimes we forget to thank them.

Scripture story	<p>Show picture 2-45, Ten Lepers, and ask the children to tell you what they remember about the picture from the previous lesson. You may want to have the children role-play the story of the ten lepers (see Luke 17:11–19).</p> <p>Referring to the picture, point to the leper thanking Christ.</p> <ul style="list-style-type: none"> • Why did this man come back to Jesus? • What did the other men do? <p>Remind the children that Jesus Christ healed all ten lepers, but only one remembered to thank him. Jesus must have been happy that one person remembered, but sad that the others did not.</p>
Discussion	<ul style="list-style-type: none"> • What should we thank Heavenly Father and Jesus Christ for? • Whom else should we thank? (Our families, teachers, friends, anyone who does something kind for us.)
We Can Thank Others	
Story and discussion	<p>Tell the following story in your own words, illustrating it with simple drawings on the chalkboard (such as a fishing pole, a fish, and a cake):</p> <p>Carlos enjoyed camping and fishing and liked to spend almost every Saturday fishing on the nearby river. But then his father died and many things changed for Carlos. He no longer had anyone to take him fishing.</p> <p>Carlos felt sad and lonely. His Primary teacher, Brother Taylor, noticed how sad he was and wanted to make him happy. Brother Taylor invited Carlos to go fishing.</p> <p>Carlos was very happy to go fishing again. He was ready and waiting when Brother Taylor came to get him. Carlos and Brother Taylor had a wonderful day at the river. They caught several fish, and that night they ate the fish for dinner with Carlos’s mother and brothers and sisters.</p> <p>Carlos wanted to thank Brother Taylor for taking him fishing.</p> <ul style="list-style-type: none"> • What could Carlos do to thank Brother Taylor? <p>After the children have responded, thank them for their suggestions and tell them what Carlos decided to do:</p> <p>Carlos decided that to thank Brother Taylor, he would do something nice for him. Carlos helped his mother make a cake, and the next day he took the cake over to Brother Taylor’s home. Carlos gave Brother Taylor the cake and said, “Thank you for taking me fishing.”</p> <ul style="list-style-type: none"> • How do you think Brother Taylor felt when Carlos brought him the cake? • How do you think Carlos felt?
Scripture	<p>Read aloud Doctrine and Covenants 78:19. Explain that this scripture says that if we are thankful, we will be happy.</p> <ul style="list-style-type: none"> • How do you feel when you say “thank you” to someone? • How do you feel when someone says “thank you” to you?
Child participation	<p>Invite the children to tell about times when someone thanked them for something they did and explain how they felt about being thanked. You may want to relate a personal experience of your own.</p>

We Can Say “Thank You” in Many Ways

Story

Tell the following story in your own words:

Sister Wells was a Primary teacher. She enjoyed teaching and loved the children in her class. She tried to have a good lesson prepared every Sunday. She loved Heavenly Father and Jesus Christ, and she told the children of her testimony and how much Jesus loved each of them. She showed love and attention to the children in her class. She always remembered their birthdays and other special occasions.

One Sunday after church, someone knocked at Sister Wells’s door. It was Rebecca, one of the girls from her class. Rebecca gave Sister Wells something in a pretty pink envelope.

- Can you guess what was in the envelope?

Bring out the thank-you note you have prepared and read it to the class.

- How do you think Sister Wells felt when she read this note?

Discussion

- How did Rebecca say “thank you” to her teacher?
- What are some other ways we can express thanks?
- Who does kind things for you?

List the children’s answers to the last question on the chalkboard. After all the children have had an opportunity to respond, refer to the list on the chalkboard and ask the children what they could thank each person for. For example, ask the children:

- What could you thank the members of the bishopric for?
- What could you thank the Primary chorister or pianist for?

Art activity

Give the children pencils or crayons and paper to make thank-you notes. Print or help them print *Thank you* on their notes, and let them decorate the notes with the pencils or crayons.

Explain that they can give this note to someone they want to thank. Let the children tell who they will give their notes to. Remind the children that thanking others not only makes those we thank happy, it also makes us happy.

Summary

Teacher presentation

Just before the end of class, thank each child for something he or she has done well during Primary. Be sincere and specific. You might thank a child for—

- Sitting reverently during class.
- Listening to the lesson.
- Saying the opening prayer.
- Treating others kindly.
- Singing in opening exercises.
- Raising a hand before speaking.
- Answering a question.
- Having a happy face during class.

Testimony

Express your gratitude for having each child in your class. Remind the children how happy a simple “thank you” can make someone feel.

Encourage the children to see how many times they can use the special words “thank you” during the week with their family and friends.

Invite a child to give the closing prayer.

Enrichment Activities

Choose from the following activities those that will work best for the children in your class. You can use them in the lesson itself or as a review or summary. For additional guidance, see “Class Time” in “Helps for the Teacher.”

1. Ask the children to stand and move their chairs apart so they will have room to walk around their chairs.

Help the children sing or say the words to the first verse and chorus of “I Have Two Ears” (*Children’s Songbook*, p. 269), using the actions indicated below:

I have two ears to hear the truth (*point to ears*),

Two eyes to see the good (*point to eyes*).

I have two feet to carry me

To places where they should (*walk around the chair*).

Chorus:

I’ll try to use them wisely

In my work and play (*pretend to bounce ball*).

I thank my Heav’nly Father

For making me this way (*sit down, fold arms, and bow head*).

2. Thread a button or ring on a piece of string or yarn long enough for all the children to hold, and tie the ends of the string together. Have the children sit in a circle and close their hands over the string. Have them pass the button or ring from child to child until you say, “Stop.” The child who has the button or ring at that point says, “I am thankful to (person’s name) for (something).” Continue the game until every child has had at least one opportunity to respond.

3. Sing or say the words to “I’m Thankful to Be Me” (*Children’s Songbook*, p. 11).

At night, when I’m alone in bed,

I close my eyes and see

The many things I’m thankful for

That God has given me.

I see my friends and teachers, too,

And others who love me.

These many blessings make me feel

So thankful to be me.

4. Prepare salt dough for the children to make into the shape of something that they are thankful for (a salt dough recipe can be found on page 43). Ask them to take their creations home and put them close to where they say their prayers. Then they will be reminded to thank Heavenly Father in prayer for their blessings.

5. Tell the story of the Jaredites in their barges, as found in Ether 2:16–18 and 6:4–11. You may want to illustrate the barges by placing two matching bowls together at the rims.

Ask the children to imagine that the Lord has told them and their families to build barges like the Jaredites'. Ask them to pretend they have been out on the ocean in these small barges for almost a year. They have been tossed in the ocean and at times have been totally submerged. There are many animals in the barges as well.

- How would you feel about taking a trip like that?

Read aloud Ether 6:9 to see how the Jaredites felt about their trip. Help the children understand that even when we are going through difficult times, we have many things to be thankful for. If we are sick, for example, we can be thankful for the people who take care of us. If we are always looking for things to be thankful for, we will see our many blessings.

6. During the next week, send thank-you notes to the children in your class, telling each one how much you appreciate having him or her in your class. Mention something specific that each child has done that has helped the class.

Choosing the Right Gives Me a Happy Feeling

Purpose To help each child understand that doing what is right makes us happy while doing what is wrong makes us unhappy.

Preparation

1. Prayerfully study Luke 15:11–24.
2. Prepare to sing or say the words to “Smiles” (*Children’s Songbook*, p. 267) and “Choose the Right Way” (*Children’s Songbook*, p. 160). The words to these songs are included at the back of the manual.
3. Materials needed:
 - a. A Bible.
 - b. A small stone or bean for each child.
 - c. The smiling/frowning face from lesson 22.
 - d. A pencil or crayon for each child.
 - e. A large paper circle for each child.
 - f. Picture 2-46, The Prodigal Son (Gospel Art Picture Kit 220; 62155).
4. Make the necessary preparations for any enrichment activities you want to use.

Note: Remember that children younger than eight years old are not yet accountable and do not need to repent of sin. Encourage the children to do what is right, but do not make them feel guilty for things they have done.

Suggested Lesson Development

Invite a child to give the opening prayer.

Follow up with the children if you encouraged them to do something during the week.

Doing Wrong Makes Us Uncomfortable

Attention activity

Have a child remove a shoe and place a small stone or bean inside it. Have the child replace the shoe and take a few steps around the room. Ask the child to tell the other children how his or her foot feels.

Point out that when things are not right, we feel uncomfortable and unhappy, and we think a lot about what is wrong.

Ask the child to remove the object and walk around the room again. Let the child tell the class how much better his or her foot feels.

Give a stone or bean to each child, and let those who want to participate put the stones or beans in their shoes. Have them stand and take a few steps to feel how uncomfortable the object is. Gather up the stones or beans and have the children stand again to see how good their feet feel when the object is gone.

Compare the stone or bean to a wrong action. When we have done something wrong, we are uncomfortable and unhappy. But when we are sorry for doing

wrong and try to correct our wrong choice, it is like taking the stone or bean out of our shoe: the uncomfortable feeling leaves and we can be happy again.

Explain that today's lesson is going to be about replacing uncomfortable feelings with happy feelings.

We Can Replace Unhappy Feelings with Happy Feelings

- How do you feel when you do something wrong?

Story and discussion

Tell in your own words the following story about a girl who did something wrong and felt unhappy. Ask the children to listen to find out what she did to replace her unhappy feeling with a happy feeling.

Angela's friend Maria had a wonderful set of play food with tiny fruits and vegetables. Angela loved to play with this food and wished it were hers. One day when Maria was not looking, Angela placed a handful of the tiny fruits and vegetables in her pocket. Angela took this food home without telling anyone about it.

- Do you think Angela had fun playing with the toy food she had taken?

Angela could not play with the toy food openly because she did not want her mother to know she had taken it. She hid the fruits and vegetables under her bed, and she had to crawl under the bed when she wanted to play with them. Angela felt unhappy inside even though she now had the toys she had wanted.

- What could Angela do to change her unhappy feeling?

Compliment the children on their appropriate suggestions, and explain what Angela did:

Angela's mother noticed her playing underneath the bed and asked what she was doing. Angela showed her mother the play food and explained how unhappy she felt. Angela's mother helped her understand what she had to do to feel happy again. Angela took the toy food back to Maria and told Maria she was sorry for taking it. After returning the toy food, Angela felt happy and relieved. She was glad she could correct her wrong choice.

- What did Angela do that was wrong?

Discussion

Display the smiling/frowning face drawing. Show the unhappy face and then the happy face.

- Which face shows how Angela felt after she took the toy food? (Invite a child to turn the drawing to the unhappy face.)
- What did Angela do to correct her wrong choice?
- Which face shows how Angela felt after she returned the food? (Invite a child to turn the drawing to the happy face.)

Tell the children that we all sometimes do things that are wrong. Doing wrong things makes us unhappy. But when we say we are sorry and try to correct our wrong choices, we can feel happy again.

Jesus Christ Wants Us to Feel Happy

Teacher presentation

Explain that saying we are sorry and trying to correct our wrong choices are two of the steps of repentance.

Have the children repeat the word *repentance* a few times.

Explain that Jesus Christ wants us to choose the right, but he knows we will sometimes do wrong things. He has made it possible for us to repent when we do wrong things. He has promised that if we repent, we will be forgiven for our mistakes and feel happy again. Repentance is an important part of being a member of Jesus' church.

Remind the children that doing something wrong is like having a stone in our shoe. We feel uncomfortable. Repentance is like taking the stone out of the shoe. It feels good to have the problem gone.

Scripture story

Show the Bible and explain that in this book of scripture the Savior tells a story about a son who chose to do something wrong and then repented and did what was right. Ask the children to listen to what the son did and how his father helped him.

In your own words, tell the story found in Luke 15:11–24. Show picture 2-46, The Prodigal Son, at an appropriate time.

Explain that sometimes this story is called “The Prodigal Son.” Tell the children that the word *prodigal* means wasteful. Explain that the younger son wanted his money because he did not want to work hard anymore. He wanted to do whatever he wanted. When he got the money, he wasted it. He spent it on things that were not good.

Explain that when the son ran out of money, he realized he had been foolish and had done wrong things. He decided to return to his father and tell him that he was sorry. He felt that he was no longer good enough to be called his father's son, but he decided to return home and ask to become one of his father's servants.

- How do you think the son felt when he realized he had done wrong things?

Read aloud Luke 15:20–24.

- What did the father do when his son came home?
- How do you think the son felt when his father greeted him?

Explain that just as this young man's father was happy that the young man changed from doing wrong things to doing right things, our parents and our Heavenly Father are happy when we try to correct our wrong choices. We are also happy when we choose to do what is right.

We Can Have Happy Feelings When We Correct Our Wrong Choices

Activity

Give each child a paper circle and a pencil or crayon. Let the children draw their own smiling/frowning faces. Show the completed smiling/frowning face so they can copy it, and help them as needed.

Describe some situations in which someone has made a wrong choice. Have the children hold up their paper faces to show how each person felt after making the wrong choice. Then ask how the person could correct the wrong choice, and have the children use the paper faces to show how each person would feel after doing so. Use the following examples or create some of your own:

1. Thomas climbed over a fence on his way home from school and tore his best pants. He knew his mother would be upset because she had told him many times not to climb the fence in his school clothes.
 - What should Thomas do?
2. Karin's mother gave her two pieces of candy, one for her and one for her sister. While her sister was gone, Karin ate both pieces of candy.
 - What should Karin do?
3. Ben went to his friend's house to play, but his friend was not home. As Ben was leaving, he saw one of his friend's toys in the yard. Ben took the toy home and played with it.
 - What should Ben do?
4. Rachel found a purse on her way to school. Later when a girl asked if she had seen the purse, Rachel said, "No."
 - What should Rachel do?
5. Philip was playing in the backyard with his brother. His brother did something that Philip didn't like, and Philip hit him and made him cry.
 - What should Philip do now?

Song Have the children hold up their smiling/frowning faces and sing or say the words to "Smiles," turning the paper faces when appropriate.

Summary

Testimony Bear testimony to the children that we can have happy feelings when we choose the right. We can also have happy feelings when we correct our wrong choices. Explain that as we learn to follow the teachings of Jesus Christ more closely, we will make fewer wrong choices.

Suggest that the children take their paper faces home and tell their families what they learned about happy and unhappy feelings.

Song Sing or say the words to "Choose the Right Way" with the children.

Invite a child to give the closing prayer. Remind the child to ask Heavenly Father to help the children recognize and correct their wrong choices.

Enrichment Activities

Choose from the following activities those that will work best for the children in your class. You can use them in the lesson itself or as a review or summary. For additional guidance, see "Class Time" in "Helps for the Teacher."

1. Using the situations you described in the section "We Can Have Happy Feelings When We Correct Our Wrong Choices," help the children think of how the wrong choices could be prevented or avoided. Let them act out their solutions.

2. Sing or say the words to "If You're Happy" (*Children's Songbook*, p. 266), helping the children make up new verses and actions about happy choices.

For example:

If you're happy and you know it, help your friends (*clap hands*)!
If you're happy and you know it, help your friends (*clap hands*)!
If you're happy and you know it, then choose the right and show it.
If you're happy and you know it, help your friends (*clap hands*)!

Other possibilities:

tell the truth (*touch mouth twice*)
share your toys (*hold one hand out, then the other*)
say your prayers (*fold arms and bow head*)

You may want to end by singing a final verse with all your ideas combined:

If you're happy and you know it, help your friends (*clap hands*), tell the truth (*touch mouth twice*), share your toys (*hold one hand out, then the other*), and say your prayers (*fold arms and bow head*)!

3. Have the children sit in a circle. Ask a review question and then toss a beanbag or other soft object to the child whom you want to answer the question. After the child has answered, have him or her toss the beanbag back to you. Continue until each child has answered at least one question.

Possible questions:

- How did your foot feel with the stone or bean in your shoe?
- How do we feel when we do something wrong?
- Why didn't Angela enjoy playing with the stolen toy food?
- What did Angela do to change her unhappy feeling?
- How do we feel when we try to correct a wrong choice?

I Can Help Others Be Happy by Sharing

Lesson
27

Purpose To encourage the children to help others feel happy by sharing with them.

Preparation

1. Prayerfully study Mark 6:30–44 and John 6:1–13.
2. Prepare a small treat for each child and yourself. If it is fast Sunday, choose something besides food for the treat and adjust the lesson as necessary.
3. Prepare to sing or say the words to the third verse of “‘Give,’ Said the Little Stream” (*Children’s Songbook*, p. 236). The words to this song are included at the back of the manual.
4. Materials needed:
 - a. A Bible.
 - b. Several items that can be shared, such as a ball, a book, and an orange. Place these items in a paper or cloth bag.
 - c. Picture 2-47, Feeding the Five Thousand (62143); picture 2-48, Jumping Rope (62523); picture 2-49, Boys Sharing a Cookie; picture 2-50, Children Sharing Blocks.
5. Make the necessary preparations for any enrichment activities you want to use.

**Suggested
Lesson
Development**

Invite a child to give the opening prayer.

Follow up with the children if you encouraged them to do something during the week.

We Can Share

Attention activity One at a time, show each of the items you have brought in the paper or cloth bag, and discuss it using the following questions:

- How many people can enjoy this (name of item) if I use it by myself?
- How many people can enjoy it if I share it?
- What are ways I could share it?

Discussion After you have discussed all the items with the children, ask:

- What do you have that you could share with someone else? How could you share it?

Encourage the children to name specific items and tell whom they could share them with and how they could share them.

If the children have not already mentioned these things, suggest that we can also share our time, our talents, and the gospel.

- How can we share our time?
- How can we share our talents?
- How can we share the gospel?

Jesus Christ Taught Us to Share

Scripture story
and discussion

Show the Bible and explain that it contains a story about a young boy who helped Jesus Christ and many other people by sharing. Tell the story found in John 6:1–13 (see also Mark 6:30–44). Show picture 2-47, Feeding the Five Thousand, at an appropriate time.

- How many loaves and fishes did the young boy have? (See John 6:9.)
- How many people do you think five loaves and two fishes would feed?
- How many people did Jesus Christ feed? (See John 6:10.)

Help the children understand that this was a large number of people. Compare the people who were fed to a group of around five thousand people that is more familiar to the children (for example, “Jesus fed as many people as there are in our town,” or “Jesus fed as many people as would fit in the local stadium”).

Explain that the boy could have eaten the food himself. But because the boy was willing to share, the Savior performed a miracle that helped thousands of people.

- How do you think the people felt when the boy shared?
- How do you think the young boy who shared felt?

Song

Sing or say the words to the third verse of “‘Give,’ Said the Little Stream.”

Remind the children that Jesus Christ has shared many things with us and wants us to share with other people.

We Can Make Ourselves and Others Happy by Sharing

Picture discussion

Tell the children that just as the young boy in Jesus’ time found a way to share, we can also find many ways to share and help others be happy. Show the pictures of children sharing (2-48, 2-49, and 2-50), one at a time, and ask the following questions for each picture:

- What are the children in this picture doing?
- What are they sharing?
- How do you think they feel about sharing? Why?

Child participation

Allow the children to talk about times when they have shared and how they feel when they share.

Point out that when we share, not only do we help others feel happy, but we feel happy too.

Praise the children if they have shown a willingness to share; then discuss with them the good feelings that sharing can give to everyone. Emphasize that sharing can give us happy feelings.

Story

Tell a story about a child who was happy and made others happy because he or she shared. You may want to use the following story:

David had a new box of crayons and was coloring a beautiful picture when his mother brought his little sister into the room. Mother asked David to share his crayons with Allison and help her color. David did not want to share. Allison did not color very well, and he was afraid she might break one of his crayons. He gave her a color he did not like very much.

Soon David needed the crayon he had given to Allison, so he tried to take it back. Allison started to cry. David felt bad for making his sister cry, and he realized that she liked to color too, even if she didn't do it very well yet. David looked at his crayons and decided there were plenty for both of them to use. He let Allison pick a color, and she colored happily on her piece of paper. David was happy too. (Adapted from Marjorie A. Parker, "Inside the Lines," *Friend*, Feb. 1993, pp. 28–29.)

- Why was Allison happy?
- Why was David happy?

Summary

Activity

Show the treats you have brought.

- How would you feel if I kept these treats all to myself?
- What would Jesus want me to do with the treats?

Divide the treats between two children, and ask them:

- What would Jesus want you to do with your treats?

Have the two children divide what they have with everyone in the class. Tell the class how you feel about sharing and how you would have felt if you had kept the treats all to yourself.

Ask the two children who divided the treats to tell how they felt about sharing the treats, and then invite the rest of the children to tell how they felt to have the treats shared with them.

Testimony

Testify to the children that sharing brings happiness. You may want to tell about a time when sharing made you happy.

Encourage each child to share something with someone this week.

Invite a child to give the closing prayer. Remind the child to ask Heavenly Father to help the children be willing to share.

Enrichment Activities

Choose from the following activities those that will work best for the children in your class. You can use them in the lesson itself or as a review or summary. For additional guidance, see "Class Time" in "Helps for the Teacher."

1. Tell the children that as a church we have an article of faith that says we believe in being benevolent. Being benevolent means that we share with other people and do other kind acts that show our love for them. Help the children memorize part of the thirteenth article of faith: "We believe in being . . . benevolent."

2. Sing or say the words to "A Prayer" (*Children's Songbook*, p. 22). Remind the children that Heavenly Father has given us many wonderful blessings and he is happy when we share our blessings with others.

Father in Heaven, on this lovely day
Please help me be happy and kind as I play.
Help me to always be honest and fair.
Help me with others my blessings to share.

3. Bring salt dough for the children and help them each make an item they like to share with their friends or family members (a salt dough recipe can be found on page 43).
4. Show a container of pencils or crayons. Explain that you have only one container of pencils or crayons, but you would like all the children to draw pictures. Give the container to a child.
 - What can (name of child) do with the crayons (or pencils) so that everyone can draw?Give each child a piece of paper, and have the children share the crayons or pencils and draw pictures of themselves sharing.
5. Have the children pantomime being missionaries (knocking on doors, reading scriptures, teaching, and doing other missionary activities).
 - What do missionaries share?
 - How do you think missionaries feel when they share the gospel with others?

Purpose To encourage each child to be kind to others.

Preparation

1. Prayerfully study Luke 10:25–37 and John 13:34–35, 15:12. See also Matthew 22:36–40 and *Gospel Principles* (31110), chapter 30.
2. Prepare to sing or say the words to “Jesus Said Love Everyone” (*Children’s Songbook*, p. 61). The words to this song are included at the back of the manual.
3. Materials needed:
 - a. A Bible.
 - b. Cutout 2-1, wounded man; cutout 2-2, priest; cutout 2-3, Levite; cutout 2-4, Samaritan.
4. Make the necessary preparations for any enrichment activities you want to use.

**Suggested
Lesson
Development**

Invite a child to give the opening prayer.

Follow up with the children if you encouraged them to do something during the week. You may want to have them tell about ways they shared during the week.

Jesus Christ Taught Us to Be Kind to Everyone

Attention activity

Show the children the map of the Holy Land found at the end of the lesson.

- What is this? (A map.)

If the children are not familiar with maps, explain that a map is a drawing of an area such as a country or city. People use maps to tell them how to get from one place to another. Point out some of the features of the map, such as the land, the sea, and the rivers.

Explain that this map shows the Holy Land, where Jesus Christ lived when he was on the earth.

Point out Judea. Explain that the people who lived in this part of the Holy Land were called Jews.

Point out Samaria. Explain that the people who lived in Samaria were called Samaritans.

Explain that during Jesus’ time the Jews and Samaritans did not understand or like each other. The Jews felt they were better than the Samaritans. Jews would not eat in the home of a Samaritan or eat food prepared by Samaritans. The Jews disliked the Samaritans so much that if they had to travel to Galilee (point out Galilee) they would go all the way around Samaria even though it was shorter to go through Samaria. Show how much farther it would be to go around Samaria than through it to get to Galilee.

Scripture story
with cutouts

Explain that when Jesus Christ was on the earth, he often told stories to help people understand his teachings. One of the stories he told was about a Samaritan.

Tell the story of the Good Samaritan, as found in Luke 10:30–37. Invite a few children to help you by holding up the cutouts at the appropriate times.

Emphasize the following points as you tell the story:

1. The wounded man was traveling from Jerusalem to Jericho (point out the two cities on the map).
2. The first man who passed by without stopping to help was a Jewish priest. Priests worked in the temple and were thought to be righteous and holy men.
3. The second man who passed by without helping was a Levite. Levites also worked in the temple and were important in the Jewish religion.
4. The third man was a Samaritan. He stopped to help the wounded man.

Explain that because this Samaritan man was so kind, he is called the Good Samaritan.

Have the children return the cutouts to you.

Dramatization
activity

Have a few children act out the story of the Good Samaritan, or let all the children play “Follow Me to Jericho” by doing the following:

Have one child lie on the floor or sit in a chair, pretending to be injured. You and the other children pretend to be traveling on the road to Jericho. Have the children follow you and do as you do.

First pretend to be the priest walking along the road. Start walking around the room. Suddenly you see someone lying by the side of the road. He is badly hurt.

- What did the priest do?

Cross over to the other side of the road, indicating that you will not help the wounded man.

Then pretend you are the Levite. Walk around the room. You see someone lying beside the road. His clothes have been stolen, and he is badly hurt.

- What did the Levite do?

Stop and look at the injured person. Then go on with your journey without helping him.

Now pretend you are the Samaritan. Walk around the room. You see someone who is badly hurt lying by the side of the road.

- What did the Samaritan do?

Act out the kind actions of the Samaritan. (If your class is large, you may want to assign children to pantomime different acts of service.) Pretend to clean the man's wounds, put him on a donkey, take him to an inn, and promise to pay the innkeeper for anything else the man needs.

Tell the children that now that they have taken care of the injured man, they are to return to their seats. Then they are to sit down and put their hands quietly in their laps.

Discussion

- Which man was kind?
- Which man did what the Savior would want him to do?

Explain that after Jesus told this story, he said we should do as the Good Samaritan did and be kind to everyone.

We Can Treat Others Kindly

Explain that being kind to everyone isn't always easy, especially if someone makes us feel bad or treats us unkindly.

Story

In your own words, tell the following story about a girl who learned a great lesson when another child treated her unkindly. Ask the children to listen for her solution to her problem.

Luisa and Todd were friends and enjoyed playing together. One afternoon, however, they got into an argument. Luisa called Todd a name, and Todd pushed Luisa down. When she began to cry, he made a face at her.

- What would you do if you were Luisa?

Luisa went to find her father. She knew that he would help her. Luisa told her father how Todd had pushed her down and had been mean to her. She asked her father to go outside and punish Todd.

Luisa's father told her that punishing Todd might not be the best thing to do. He told Luisa to go into the kitchen instead and spread some jam on two pieces of bread. Then he told her to take one of the pieces of bread to Todd. If she did that, Luisa's father said, she would have a friend instead of an enemy.

Luisa did as her father told her. When she went back outside and offered the bread and jam to Todd, he looked at her for a moment and then took the gift. Todd and Luisa smiled at each other and sat down to enjoy their bread and jam. They were friends again. (Adapted from Lucile C. Reading, "A Piece of Bread and Jam," *Children's Friend*, Apr. 1967, p. 13.)

Discussion

- What did Luisa want to do after Todd pushed her?
- What is our first reaction when someone is unkind to us?
- What happened when Luisa was kind to Todd?
- What would have happened if Luisa had not been kind to Todd?

Remind the children that Jesus wants us to be kind even if others are not kind to us.

Scripture

Show the Bible and read aloud John 15:12. Explain that these are Jesus Christ's words. He commanded us to love one another. When we are kind to each other, we are showing our love.

Song

Sing or say the words to "Jesus Said Love Everyone" with the children. Explain that this song can remind us to be kind and do what Jesus would have us do.

Discussion

Describe some situations in which the children could choose to be kind, and ask the children what they would do in each situation. Remind them to think of the words of the song if they need help deciding how to act. Use the following situations or create some of your own:

1. As you are walking down the street, you see that someone has had a bicycle accident. As you get closer, you see that it is a boy who is always teasing you. His pant leg is caught in the chain of his bicycle. He cannot move without help.
 - What could you do to be kind to the boy?
2. You have planned a special party for your birthday next week, and you want to invite all the children in your neighborhood except one. She is new in the neighborhood. She never smiles and isn't much fun to play with.
 - What could you do to be kind to this girl?
3. While playing with your friends you fell down. One of your friends called you clumsy and laughed at you. Now your friend has fallen down and is crying.
 - What could you do to be kind to your friend?
4. A boy in your class at school uses braces to help him walk. When all the children go out to play, he gets left behind because he walks slowly. He often sits by himself, watching everyone else play ball.
 - What could you do to be kind to this boy?

Summary

Review

Have the children review the lesson by answering the following questions:

- What have we learned in today's lesson?
- Why is it important to be kind?
- When we show kindness, whose example are we following?

Scripture

Read aloud John 13:34–35. Explain to the children that when we love others and are kind to them, we show that we are disciples (followers) of Jesus Christ.

Testimony

Testify to the children that Jesus wants us to show love for others by being kind. Remind the children that we should be kind to everyone, even to those who do not always treat us kindly. Bear your testimony about the importance of following Jesus by choosing to be kind.

Encourage the children to make a special effort to be kind to others during the coming week. Remind them to think of the words to the song "Jesus Said Love Everyone" when they need to remember how to treat someone. Ask them to notice what happens when they choose to be kind. Suggest that they come ready to tell about their experiences next week.

Invite a child to give the closing prayer.

Enrichment Activities

Choose from the following activities those that will work best for the children in your class. You can use them in the lesson itself or as a review or summary. For additional guidance, see "Class Time" in "Helps for the Teacher."

1. Give the children paper and crayons or pencils and let them draw pictures of ways they can show love for others by being kind. Label each child's picture with the words *I can be kind to others*.

2. Help the children sing or say the words to “Kindness Begins with Me” (*Children’s Songbook*, p. 145).

I want to be kind to ev’ryone,
For that is right, you see.
So I say to myself, “Remember this:
Kindness begins with me.”

Help the children think of people they could be kind to (such as family members, friends, or classmates) and ways they could show kindness to these people. Help the children understand the importance of being kind to those who are not kind to us or who seem different from us.

3. With the children, sing or say the words to “A Special Gift Is Kindness” (*Children’s Songbook*, p. 145).

A special gift is kindness.
Such happiness it brings;
When I am kind to others,
My heart sings.

After you sing or say the words to the song, tie a piece of string or yarn around each child’s finger or wrist. Explain to the children that the string is to remind them to be kind to everyone, and suggest that they wear the string or yarn for the rest of Primary.

The Holy Land

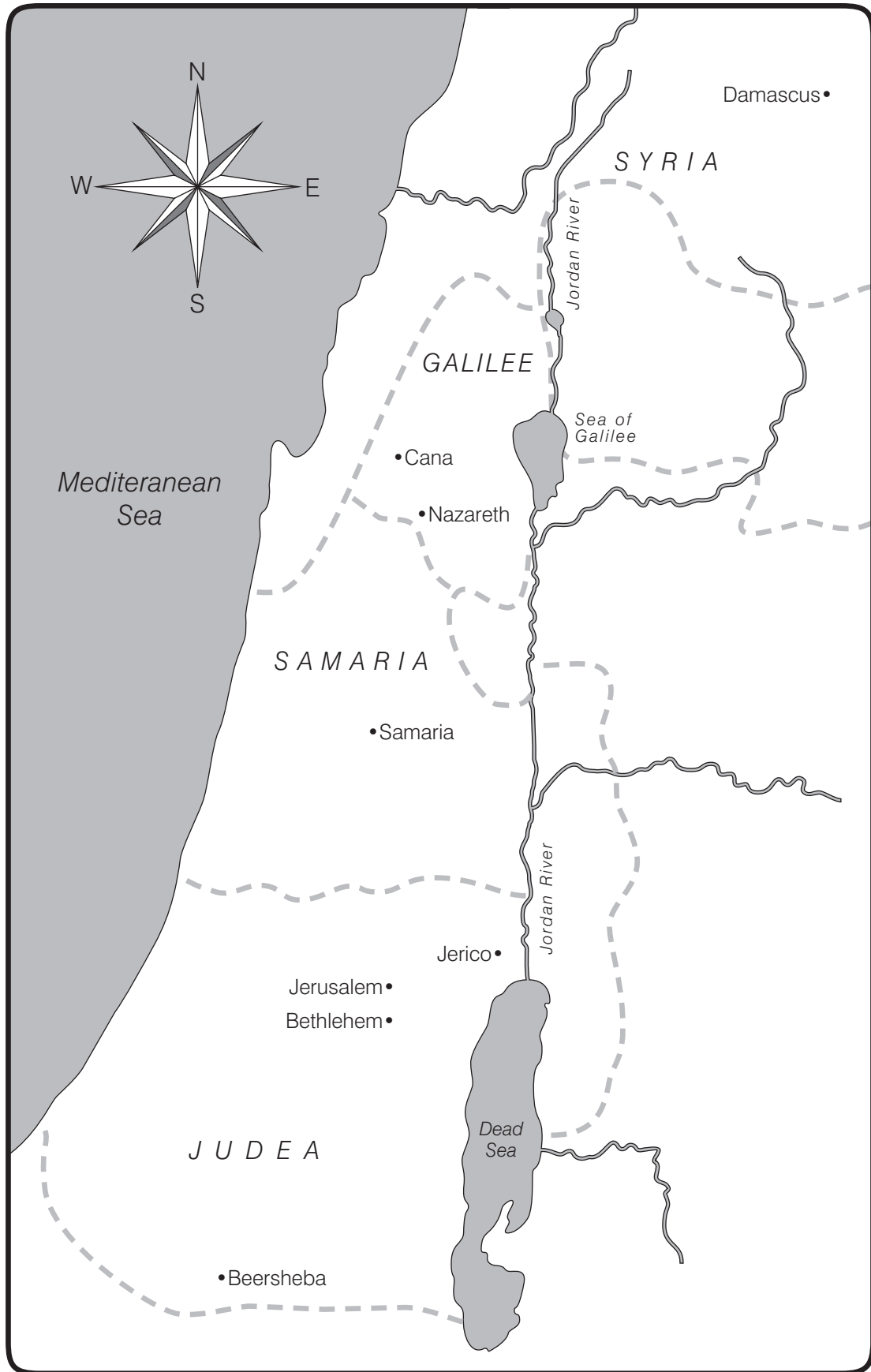

I Can Be a Good Example

Lesson
29

Purpose To encourage the children to let their lights shine as followers of Jesus Christ.

Preparation

1. Prayerfully study Matthew 5:14–16.

2. Copy and cut out four paper candles and four paper baskets, using the patterns at the end of the lesson. Write the following names on the paper candles:

Susan

José

Eric and Peter

?

Before class begins, display the three candles with names and cover each candle with a paper basket. Save the fourth candle (“?”) and basket to be used later.

3. Use the candle pattern to make a paper candle for each child.

4. Prepare to sing or say the words to “Choose the Right Way” (*Children’s Songbook*, p. 160) and “Jesus Wants Me for a Sunbeam” (*Children’s Songbook*, p. 60). The words to these songs are included at the back of the manual.

5. Materials needed:

- a. A Bible.
- b. A candle and a candlestick or holder.
- c. A basket or box that will completely cover the candle.
- d. CTR chart (see lesson 1).
- e. Pencils or crayons.

6. Make the necessary preparations for any enrichment activities you want to use.

Note: Do not light the candle that you use during the lesson. It is against Church policy to light candles in the meetinghouse.

**Suggested
Lesson
Development**

Invite a child to give the opening prayer.

Follow up with the children if you encouraged them to do something during the week. You may want to have them share their experiences with showing kindness. Whisper as you talk with the children.

Jesus Christ Taught, “Let Your Light Shine”

Attention activity

Continue whispering to the children, asking about what they did this week or what they like about Primary, until some of the children start whispering back.

After a few minutes, explain that you were whispering as part of an experiment to show how people often do what other people around them are doing. Point out that the children started to whisper because you were whispering to them. They followed your example.

Tell the children that just as they followed your example, their friends often follow their examples. Jesus Christ wants us to be good examples.

- What does it mean to be a good example?

Explain that our friends will often do what they see us do. If they see us doing good things and choosing the right, it will be easier for them to choose the right also.

Riddle

Invite the children to solve the following riddle:

I am made of wax.
Inside me is a wick.
My purpose is to give light.
A match can make me burn.
What am I?

After the children solve the riddle, show the candle you have brought and discuss what candles are used for.

Scripture story

Explain that when Jesus Christ lived on the earth, there were no electric lights. After the sun went down and it got dark, people sometimes burned candles in their homes so they would have light to see.

Tell the children that one day Jesus was teaching his disciples a lesson about being a good example to others (see Matthew 5:14–16). To help the disciples understand how their actions could help others, Jesus compared the actions to the light of a candle. Read aloud what Jesus told his disciples, as found in Matthew 5:15.

Object lesson

Put the candle under a basket or box.

- What would happen if it were dark and we lit the candle but then covered it with a basket (box)? (No one could see the light.)

Remove the basket or box and put the candle on a candlestick.

- What would happen if it were dark and we put the candle on a candlestick and then lit the candle? (The candle would give light to the room, and everyone would be able to see.)

Explain that Jesus wanted his disciples to be like the candle and give light to others. If the disciples followed Jesus' teachings and were good examples, then other people would see what they should do.

Discussion

Read aloud from Matthew 5:16 what Jesus said to his disciples. Explain that Jesus wants us to follow this instruction too.

- What does *let your light so shine* mean in this scripture? (Be a good example.)
- What can happen when we are good examples for our friends and those around us?

Children Can Be Good Examples

Tell the children that we can all follow Jesus Christ's instruction to let our lights shine by being good examples for others. When we choose to follow Jesus, other people can learn about him by watching us.

Ask a child to uncover a paper candle by removing the paper basket that covers it. Read the name or names on the candle. Then tell the story that goes along with that candle. Repeat with the other two baskets and candles, telling the other two stories.

Story about Susan

Susan was invited to a birthday party for her friend Carolyn. She was excited to go to the party and was sure she would have a good time. When she came home, however, she did not look as excited as she did when she left. Susan's mother asked her how the party was.

Susan explained that iced tea was served at the party. Carolyn's mother had said it was just like a party grown-ups would have.

- What do you think Susan did when she was offered some tea?

Susan told Carolyn's mother that she did not drink tea and explained that she had been taught by her parents and Primary teachers that tea was not good for her body.

Susan's mother was proud of Susan for not drinking any tea. She explained that Carolyn and her mother were not members of the Church and did not believe the same things Susan's family did.

A few months later Susan and her mother received a letter from Carolyn's mother. Carolyn's mother explained that after Susan stood up for what she believed at the party, Carolyn's family decided to find out more about the Church. They were being taught by the missionaries. Carolyn's mother said she hoped she could be a good example to someone else like Susan was to her.

- How did Susan let her light shine?

Story about José

José and his family had just moved to a new neighborhood. José's first new friend was a boy named Paolo, who was not a member of the Church. José and Paolo both loved football. One day Paolo invited José to go to a football game the next Sunday. José knew he shouldn't go to football games on Sunday, but he was worried that if he did not go, Paolo's feelings would be hurt.

- What would you do if you were José?

José decided to go to church instead of going to the football game, and he invited Paolo to go to church with him. Paolo agreed to go to church with José.

- How was José a good example?

Story about Eric and Peter

One day a woman came to see some missionaries in Holland. She asked the sisters to teach her how to pray. The woman explained that her sons, Eric and Peter, had been attending Primary and liked it very much. At Primary they learned how to pray.

The woman explained that a few days ago her baby girl had been very sick. She left the room for a few minutes, and when she came back Eric and Peter were kneeling by the baby's bed. Peter was asking Heavenly Father to bless the baby and make her well. The mother was glad that her sons had learned how to pray at Primary and wanted the missionaries to teach her how to pray too.

The missionaries taught the woman how to pray. They were happy that Eric and Peter were good examples for their mother.

- How did Eric and Peter let their lights shine?

Child participation When you have told all the stories, display the “?” candle, covered with a paper basket. Ask a child to remove the basket. Explain that the “?” on the candle stands for any of the children who has been a good example. Invite the children to tell about times when they were good examples.

We Can Let Our Lights Shine

Scripture Read aloud Matthew 5:16 again. Remind the children that Jesus is telling us to let our lights shine. Emphasize the importance of letting our lights shine by being good examples. Point out that as members of The Church of Jesus Christ of Latter-day Saints we should follow the teachings of Jesus Christ and help others follow Jesus’ teachings also.

Song Sing or say the words to “Jesus Wants Me for a Sunbeam” with the children. Help them understand that being “sunbeams” for Jesus means letting our lights shine, as the scripture says.

Activity Tell the children that you are going to describe some situations and give two choices they could make in each situation. Ask the children to listen carefully to each choice. If the choice is a good one, the children should each hold one finger high in the air to represent their candles on candlesticks. If the choice is not good, they should each cover the finger with their other hand, to represent hiding their lights under bushels. After each situation, discuss which choice is better and why it is an example of letting our lights shine.

Use the following situations or create some of your own:

1. You have been playing all morning with some friends in your neighborhood and have been having lots of fun. After lunch a girl who is visiting the family across the street comes outside and looks like she wants to play with you. What do you do?
 - a. Since you and your friends don't know the girl and she doesn't know what you've been playing, you don't invite her to play with you.
 - b. You say to your friends, “Let's invite that new girl to come and play with us. She looks like she wants to play.”
2. You are playing ball with your friends. You hit the ball hard, and it hits your neighbor's window and cracks it. What do you do?
 - a. You tell your neighbor that you were playing ball and you hit the ball so hard that it hit the window and cracked it. You explain that you are sorry and offer to pay for the broken window.
 - b. You go look at the cracked window. Since it isn't cracked very badly, you tell your friends that no one will ever notice it. You continue playing ball and try to be more careful.
3. You are waiting in line for lunch at school (or waiting to go to your Primary class). Some of the children in line get restless and start playing. The child behind you pushes you. What do you do?
 - a. Stand in line without pushing anyone.
 - b. Push the person who pushed you.

Remind the children how important it is to be a good example by choosing the right.

Summary

CTR chart	<p>Point to the CTR chart and remind the children that we will choose the right if we follow the teachings of the Savior.</p> <p>Encourage the children to be good examples to others, just as Susan, José, and Eric and Peter were good examples.</p>
Candle activity	<p>Give each child a paper candle. Write or have the children write their names on their candles.</p> <p>Help the children think of ways they can let their lights shine by being good examples at home, school, and church.</p> <p>Have each child tell one way he or she will be a good example this week.</p> <p>Let the children take their candles home to remind them to let their lights shine by being good examples.</p>
Testimony	<p>Testify to the children of the importance of being a good example. You may want to share a personal experience when you were a good example or when someone else's example helped you learn about Jesus Christ.</p>
Song	<p>Sing or say the words to "Choose the Right Way" with the children.</p> <p>Invite a child to give the closing prayer and ask Heavenly Father to help the children be good examples for others.</p> <p>As the children leave your classroom, invite them to walk out quietly with their paper candles held in front of them. (If the children must wait for someone to pick them up from the classroom, invite them to show their candles to the person picking them up.)</p>

Enrichment Activities

Choose from the following activities those that will work best for the children in your class. You can use them in the lesson itself or as a review or summary. For additional guidance, see "Class Time" in "Helps for the Teacher."

1. Have the children act out the better solutions to the situations they discussed in the section "We Can Let Our Lights Shine." The children could also role-play the stories of Susan, José, and Eric and Peter.
2. Sing or say the words to "Do As I'm Doing" (*Children's Songbook*, p. 276). The words to this song are included at the back of the manual. Let the children take turns leading the song by demonstrating an action for the other children to copy.

Or let the children play "Follow the Leader," giving each child a turn to be the leader.

Point out that in this song or game, everyone follows the leader's example. Remind the children that when they choose the right, they are being good examples for those around them.

3. Sing or say the words to "Shine On" (*Children's Songbook*, p. 144).

My light is but a little one,
My light of faith and prayer;
But lo! it glows like God's great sun,
For it was lighted there.

Chorus:

Shine on, shine on, shine on bright and clear;
Shine on, shine on now the day is here.

I may not hide my little light;
The Lord has told me so.
'Tis given me to keep in sight,
That all may see it glow.

Chorus

4. Ask each child a review question, whispering as you did in the attention activity. Have the children respond in whispers. Compliment them for listening and thinking carefully.

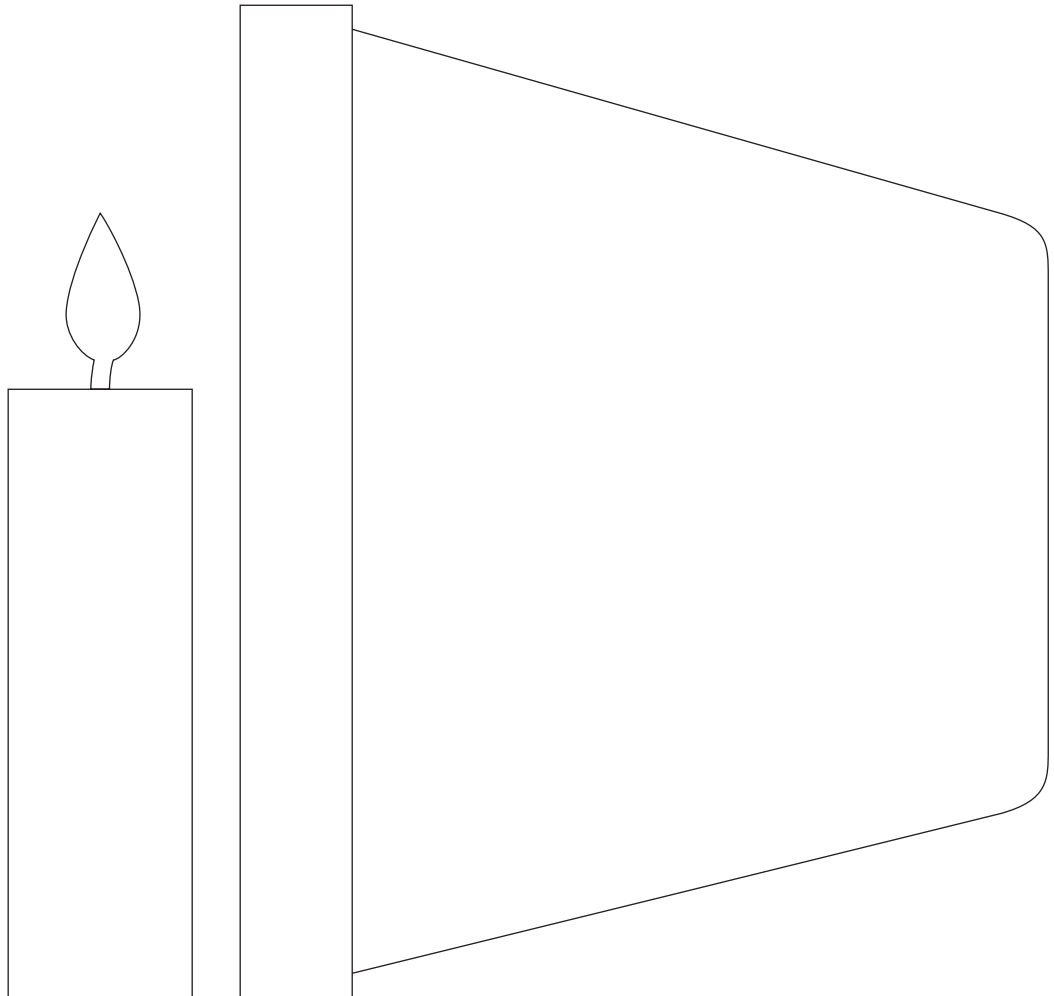

I Can Be Obedient

Lesson

30

Purpose To encourage each child to follow Jesus Christ's example by being obedient.

Preparation

1. Prayerfully study Exodus 20:12, Matthew 26:36–46, John 8:28–29, and Colossians 3:20. See also *Gospel Principles* (31110), chapter 35.

2. Make the following wordstrip:

Obedient

3. Print *I Can Obey* on a paper badge for each child. Bring tape or pins to attach a badge to each child's shirt or dress, or bring yarn to hang the badges around the children's necks.

4. Be prepared to sing or say the words to all three verses of "Quickly I'll Obey" (*Children's Songbook*, p. 197). The words to this song are included at the back of the manual.

5. Materials needed:

a. A Bible.

b. Picture 2-51, Geese with Goslings; picture 2-52, Jesus Praying in Gethsemane (Gospel Art Picture Kit 227; 62175).

6. Make the necessary preparations for any enrichment activities you want to use.

Note to teachers of older children: You may want to use enrichment activity 1 as the attention activity.

**Suggested
Lesson**

Development

Invite a child to give the opening prayer.

Follow up with the children if you encouraged them to do something during the week. You may want to have the children tell about ways they were good examples during the week.

Obedience Brings Happiness

Attention activity

Show picture 2-51, Geese with Goslings. Ask a child to hold the picture while you tell in your own words the following story about Elder Theodore M. Burton, who was a General Authority of the Church:

When Theodore M. Burton was only five years old, he visited his grandmother on her farm. Theodore liked to play outside at the farm. On this visit Theodore's grandmother warned him not to get too close to the hen with the baby chicks because the hen might think he was trying to hurt her babies. Theodore promised he would not get too close.

But when Theodore saw the fuzzy yellow chicks, he just had to touch one. The chick ran away, but the mother hen ran toward Theodore and pecked his hand with her hard beak. Theodore ran crying to his grandmother.

Theodore's grandmother hugged him until he stopped crying and then explained that the mother hen thought Theodore was going to hurt her babies. She was trying to protect her chicks when she pecked him.

Grandmother sent Theodore outside again, reminding him to stay away from the hen. She warned him not to get too close to the mother goose either, because she also had babies. The mother goose was bigger than the hen, so she might really hurt someone who touched her babies. Theodore promised he wouldn't touch the goslings.

Theodore stayed away from the mother hen. But when he saw the mother goose and her goslings, he moved closer to see them better. Spreading her wings and stretching her neck, the mother goose hissed loudly at him. Theodore was frightened and ran back into the house. (See Theodore M. Burton, "Friend to Friend: Grandmother's Lesson," *Friend*, Oct. 1973, pp. 18–19.)

Discussion

- Why did Theodore's grandmother tell him not to go near the hen or the goose?
- How did Theodore feel when he disobeyed his grandmother?
- Why did he feel this way?
- What do you think Theodore learned from this experience?

Tell the children that Theodore's grandmother told him that he had people to protect him, just as the hen and goose protected their babies. Explain that our parents and families and Heavenly Father and Jesus Christ watch over and protect us. They will teach us what to do to be safe and happy. It is important that we learn to obey them.

Wordstrip

Display the wordstrip "Obedient." Have the children say the word aloud with you a few times. Explain that we are obedient when we do what Heavenly Father, our parents, and our leaders want us to do.

Say the word *obey* and have the class repeat it. Explain that to obey means the same as being obedient.

We Can Obey Heavenly Father As Jesus Christ Did

Scripture

Explain that in the Bible, Jesus Christ taught that it is important to obey Heavenly Father. Read aloud the following phrases from John 8:28–29: "I do nothing of myself; but as my Father hath taught me. . . . For I do always those things that please him."

Explain that these are Jesus Christ's words, and they mean that Jesus always did what Heavenly Father wanted him to do. He did only the things that he knew would make Heavenly Father happy.

Scripture story

Display picture 2-52, Jesus Praying in Gethsemane, and briefly tell the story found in Matthew 26:36–39.

Read aloud what Jesus Christ said in his prayer: "O my Father, if it be possible, let this cup pass from me" (Matthew 26:39). Explain that Jesus did not want to suffer and die if there were another way to help us return to Heavenly Father.

Read aloud what Jesus said next: “Nevertheless not as I will, but as thou wilt” (Matthew 26:39). Explain that this means Jesus was willing to do what Heavenly Father wanted, even though it was not easy. Explain that we will not be asked to do something as difficult as what Jesus did; however, we should obey Heavenly Father in whatever he wants us to do.

- What are some things Heavenly Father has asked us to do? (Answers may include pray, love one another, be baptized and confirmed, and be honest.)

We Can Obey Our Parents

Scripture discussion

Explain that if we obey Heavenly Father, we will also obey our parents. (If some of the children in your class do not live with their parents, adjust this discussion as needed. For example, children should also obey their grandparents.) Point out that one of the Ten Commandments tells us to obey our parents. Read aloud the first part of Exodus 20:12: “Honour thy father and thy mother.” Explain that obeying our parents is one way to honor them.

- Why should we obey our parents?

Read aloud Colossians 3:20 (remind the children that *the Lord* is another name for Jesus Christ). Help the children memorize the first part of the verse: “Children, obey your parents in all things.”

- How do you feel when you obey your parents?
- How do your parents feel when you obey them?

Song

Have the children stand and sing or say the words to all three verses of “Quickly I’ll Obey.”

Encourage the children to decide now that they will obey Heavenly Father and their parents.

Story

Tell a story about a child who was happy because he or she obeyed his or her parents. You may want to use the following story:

Kathryn loved to play at her friend April’s house. Kathryn’s mother had said Kathryn could play for one hour. When April’s mother said the hour was up, it was hard for Kathryn to leave. She wanted to finish the game that she and April were playing. Kathryn thought for a moment and decided she would go home as her mother had told her to do. Quickly she said good-bye to April and ran home.

When Kathryn got home, her grandmother was waiting for her. Grandmother wanted Kathryn to come spend the night at her house, but she was in a hurry to get home. If Kathryn had not come home when her mother had told her to, she would have missed the chance to visit her grandmother.

- How do you think Kathryn felt?

Emphasize that we will not always receive an exciting reward when we are obedient, but we will have a happy, peaceful feeling. This feeling comes from knowing that we have chosen to do what is right.

Summary

Child participation

Invite the children, one at a time, to tell about a time when they were obedient and how they felt, or about a way they can be obedient in the future (such as

keeping one of Heavenly Father's commandments, asking parents' permission before going out to play, helping clean up the home, or coming the first time a parent calls).

At the end of each child's turn, give him or her an "I Can Obey" badge. Encourage the children to keep their badges where they can see them often, so the badges will help them remember to obey. Suggest that the children explain their badges to their families and share what they learned from the lesson today.

Testimony

Share your testimony of how obeying Heavenly Father and your parents has blessed your life. You may want to tell about a time when obedience made you happy.

Encourage the children to quickly obey their parents during the coming week.

Invite a child to give the closing prayer.

Enrichment Activities

Choose from the following activities those that will work best for the children in your class. You can use them in the lesson itself or as a review or summary. For additional guidance, see "Class Time" in "Helps for the Teacher."

1. Draw a large circle on the chalkboard with two smaller circles inside it (see illustration).

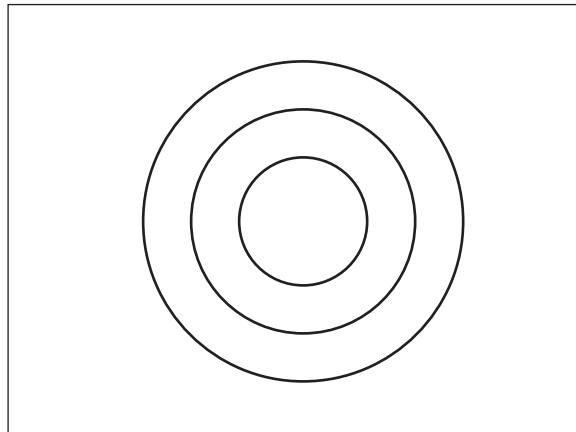

Explain that the object of this activity is to make an X inside the smallest circle while wearing a blindfold. Ask for a volunteer to try it. Blindfold the volunteer and give him or her a piece of chalk. Turn the blindfolded child around two or three times and then place him or her in front of the chalkboard. Have the child make an X on the chalkboard. Then ask the child to make another X after receiving instructions about where to place the X. Have a second child give the blindfolded child instructions such as "higher," "lower," "to the left," "to the right."

Look at the two markings and discuss how much better the blindfolded child did when he or she obeyed the instructions of the other child.

- Why did (blindfolded child's name) do better at placing the X when she (he) obeyed the instructions?

Allow each child who wants to participate to be blindfolded and try to put an X in the circle while another child gives instructions.

Point out that the blindfolded children were more successful at placing the marks in the circle when they obeyed the instructions of someone who could see the circles better. Explain that sometimes Heavenly Father and our parents can see things in our lives better than we can. They give us instructions to help us. When we obey Heavenly Father and our parents, we will be happy.

2. Tell the following story in your own words:

Matthew loved matches. If there were candles to be lit or a fire to be started, he always wanted to help. Sometimes his parents let him strike a match, but they always stood close by to make sure he was careful.

One day when his parents were not in the room, Matthew saw a box of matches on the table. He thought about what fun it would be to light every one of the matches himself. He was certain he would be careful.

Then Matthew thought about how his mother had told him many times that matches were not toys and that he must never use them without permission. Quietly Matthew turned away from the matches and went outside to play.

Talk with the children about the possible consequences if Matthew had taken the matches. Emphasize that Matthew's obedience was helpful to the family even though no one was aware of it.

You may want to continue the discussion by asking:

- What should Matthew do if his older brother tells him to bring the matches to their bedroom so they can play with them?

Explain that when someone tells us to do something we know is wrong, we should not obey. Heavenly Father doesn't expect us to obey when we are told to do something wrong.

3. Prepare pieces of paper with simple instructions such as the following:

- Erase the chalkboard.
- Shake hands with each member of the class.
- Sing or say the words to "Do As I'm Doing."
- Say something kind about each class member.
- Tell five things that you are thankful for.
- Act out something that you will do for a family member during the week.

Put the pieces of paper in a container. Have the children take turns choosing a paper from the container and obeying the instructions written on it.

4. Before class, prepare and hide clues for a small treasure hunt in your classroom. Each clue should lead the children to the next clue until the final clue leads to the treasure. You may want to have a small treat or gift for each child as the treasure at the end of the hunt.

Discuss with the children how they must obey the instructions on each clue to find the treasure. Read the first clue aloud to start the treasure hunt.

After the children have finished the treasure hunt, help them understand that if we obey our Heavenly Father, he will give us the greatest treasure of all: he will let us live with him forever.

5. Review the story of Noah and the ark, as found in Genesis 6–8. Explain that because Noah was obedient, he and his family were saved from the flood. Encourage the children to obey the commandments of Heavenly Father and Jesus Christ, as Noah did.

Give each child a copy of the handout at the end of the lesson. Let the children color the picture of the ark and then draw a picture showing how they can be obedient.

Noah Was Obedient

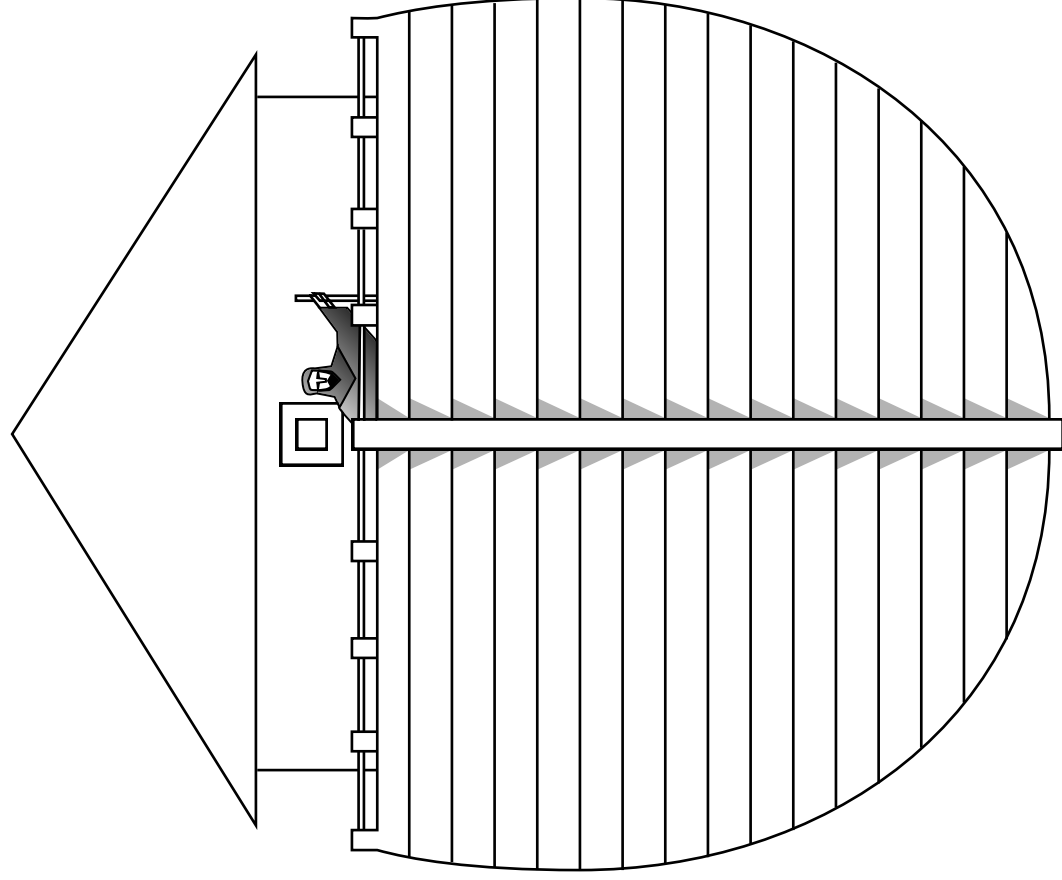

I Can Be Obedient

I Will Obey the Law

Purpose

To help each child understand the importance of respecting and obeying the laws of the land.

Preparation

1. Prayerfully study Matthew 22:15–22 and Articles of Faith 1:12.
2. Prepare enough salt dough for each child to have a piece. A salt dough recipe can be found on page 43. (If salt dough is not available, bring crayons and paper for the children to use.)
3. On a sheet of paper, list some situations involving laws and rules that the children are familiar with. Describe at least one situation for each child in the class, and number the situations. Use the situations below or create others more appropriate for the children in your class:
 - You are almost late for school. If you cross the street in the middle of the block instead of at the crosswalk, you will get there sooner. What will you do if you obey the law?
 - You are shopping with your father and ask for a candy bar. Your father says no, but while he is busy paying for the groceries, you see that you could slip the candy into your pocket without anyone noticing. What will you do if you obey the law?
 - You are taking your dog for a walk on a leash. You come to a park and want to stop and play, but there is a sign saying “No Dogs Allowed.” You don’t see any grown-ups around, and you could tie the dog’s leash to a tree while you play. What will you do if you obey the law?
 - You are crossing the street at a corner that has a traffic light. No cars are coming, and no one is around. But your light says to wait. What will you do if you obey the law?
 - You are at the library and have found a book you want to check out, but you left your library card at home. The librarian is not at the front desk and would not see you leave with the book. What will you do if you obey the law?
4. Prepare as many small pieces of paper as you have situations. Number the papers and put them in a bowl or basket.
5. Make a paper badge for each child:



6. Make the following wordstrip:

We believe in obeying the law.

7. Materials needed:

- a. A Bible.
- b. A coin (with a picture of a national leader on it, if possible).
- c. Pins, tape, or yarn to attach the badges to the children's clothing.
- d. Picture 2-53, Render unto Caesar.

8. Make the necessary preparations for any enrichment activities you want to use.

**Suggested
Lesson
Development**

Invite a child to give the opening prayer.

Follow up with the children if you encouraged them to do something during the week.

Rules and Laws Can Help Us

Attention activity

Give the children pieces of salt dough and have each one shape a farm animal. (If salt dough is not available or this activity is too difficult for the children in your class, give the children crayons and paper and have them each draw a farm animal. Adjust the discussion accordingly.)

Display all the animals on the table or floor. Explain that farmers must take very good care of their animals and give them food, water, and protection. If the animals wander away, they might get lost or injured.

- What could we do to keep these animals from wandering away? (Build a fence.)

Roll a piece of dough between the palms of your hands and the table to form a long rope. Encircle the animals with it to form a fence. Explain that fences are good because they help keep animals safe. (Leave the animals on display during the rest of the lesson. At the end of the lesson let the children take their animals home.)

Explain that we have things that keep us safe too. These things are called laws and rules. Laws and rules are like fences because they stop us from doing things that are dangerous or that might make us or other people unhappy. When we obey laws and rules, they help keep us safe and happy.

Discussion

Choose a simple game familiar to every child in your class, such as tic-tac-toe. Have the children tell you the rules of the game and discuss what would happen if you tried to play the game without obeying the rules. Help the children see that rules are necessary for games to be successful and fun to play.

- What other kinds of rules are there besides game rules?
- What are some rules in your home?

Have each child tell a rule his or her family follows, such as "Put the toys away when you are finished playing." As each child mentions a rule, ask:

- How does this rule help you?

When each child has told a family rule, point out that we have rules in other places besides our homes.

- What are some of the rules at school? in Primary?
- How do these rules help you?

Our Country Gives Us Laws

Story and discussion

Explain that just as we have rules at home, at school, and in Primary, we have rules for our town and country. These rules are called laws. Laws help and protect us just like our home, school, and Primary rules do. Tell a story about a child who learned how laws protect and help us when we obey them. Use the story below or create one of your own:

Jerry had always wanted a dog of his own, so he was excited when he was given a beautiful puppy for his birthday. He named the dog Pal. Jerry and Pal had a lot of fun together.

Jerry's city had a law that said all dogs must be on leashes when they were not in a fenced yard. One day Jerry decided to take Pal with him to a friend's house. He could not find Pal's leash, and his friend only lived a few houses away, so Jerry decided to take Pal without the leash.

As they walked down the street, Pal saw a cat on the other side of the road. Before Jerry realized what was happening, Pal ran into the road and was hit by a car.

With tears in his eyes, Jerry picked up the dog and carried him home. Jerry's mother took them to the veterinarian, who took care of Pal's broken leg.

When they got home, Jerry's mother told him that Pal could have been killed. Jerry realized that if he had obeyed the law and kept his dog on a leash, Pal would not have been hurt. Jerry realized that the law was there to protect him and his dog, and he decided he would never disobey that law again.

- Why do you think Jerry's city had a law about keeping dogs on leashes?
- How could Pal's accident have been prevented?
- Why do we have laws and rules that we must follow?

Discussion

Explain that laws are made to help and protect us. Ask the children to name some basic laws in your area. Discuss each law and why it was created. Help the children see how each law is helpful.

You may want to use some of the following ideas if they apply in your area:

Traffic Laws

- Stop at all stop signs. This helps us avoid accidents.
- Observe speed limits. Speed limits are set so people can drive safely and be able to stop quickly in an emergency.

Laws Regarding Pets

- Keep your pet on a leash when it is out of your yard. Leash laws can protect animals from getting hurt (like Jerry's dog, Pal) and protect people's property from damage caused by animals.
- Don't be cruel to animals. This kind of law protects animals from being hurt.

Laws Regarding Personal Property

- Do not steal. If we take things that belong to someone else, everyone will be unhappy.
- Do not litter. If everyone litters, then our city or town will be ugly and untidy. Our parents may have to pay (through taxes) to have it cleaned up.

Jesus Christ Wants Us to Obey the Law

Discussion

- What are taxes?

Explain that taxes are money we give to our state or country to help pay for things that benefit everyone, such as police officers, firefighters, roads, and schools. Briefly discuss what it would be like not to have these things. Explain that we have tax laws to make sure everyone helps pay for these things.

Scripture story

Explain that the people in Jesus Christ's time also had tax laws. Show picture 2-53, *Render unto Caesar*, and tell the story found in Matthew 22:15–22.

Explain that the people asked Jesus if they should pay tribute money to their country. Tribute money is like tax money.

Show the coin you brought. Explain that Jesus asked the people to show him a coin. He pointed out that the coin had on it a picture of Caesar, the leader of the country. (If the coin you brought has a picture of a national leader on it, point it out.) Read aloud what Jesus told the people, as found in Matthew 22:21 (beginning with *Then saith he*). Explain that Jesus told the people that they should obey their country's laws *and* Heavenly Father's laws. Jesus taught the people that it was important to obey the laws of their country.

We Believe in Obeying the Law

Wordstrip

Read aloud the sentence on the wordstrip. Explain that this is part of the twelfth article of faith, one of the Church's statements of belief.

Have the class repeat the sentence together a few times.

Game

Place the list of situations and the bowl or basket of numbers on a table or the floor. Tell the class that they can now play the "Obeying the Law" game. Then sit back and wait a moment or two. If no one responds, ask:

- Why isn't anyone playing the game? (No one knows the rules.)

If the children have tried to make sense of the situation, perhaps by putting the numbered papers in order, compliment them for trying, and then ask:

- Are you playing the "Obeying the Law" game?
- Why not?

Point out that rules and laws help guide us and give us direction. Explain the rules of the game:

1. Pick a number from the bowl (or basket).
2. Take your turn in order, starting with the person who picked number one.
3. Stand during your turn.
4. Give your number to the teacher, and then answer the teacher's question without help from the other children.
5. Sit quietly in your chair before and after your turn.

Play the game, letting each child pick a number from the bowl or basket. Read to each child the situation that corresponds with his or her number.

When each child has answered a question, give the badges to the children. Praise the children for their good ideas and answers.

Summary

Child participation	Ask the children what they will say when their families ask about their badges. As they share their answers, stress the importance of obeying the laws so we can live together in happiness.
Testimony	Testify that laws are created for our good. You may want to share a personal experience when you were thankful that you obeyed the law. Remind the children to obey Heavenly Father's laws and their country's laws. Encourage each child to choose one law to obey carefully this week. Invite a child to give the closing prayer. Suggest that the child ask Heavenly Father to help the children remember and obey the laws.

Enrichment Activities

Choose from the following activities those that will work best for the children in your class. You can use them in the lesson itself or as a review or summary. For additional guidance, see "Class Time" in "Helps for the Teacher."

1. Help the children memorize the twelfth article of faith: "We believe in being subject to kings, presidents, rulers, and magistrates, in obeying, honoring, and sustaining the law." Explain any words unfamiliar to the children.

Younger children can memorize the part of the article of faith written on their badges: "We believe in obeying the law."

You may want to sing "The Twelfth Article of Faith" (*Children's Songbook*, p. 131) to help the children memorize.
2. Ask the class to think of five rules families might have that help keep family members safe and happy. Have each child hold up a finger as each rule is named. When five rules have been named and each child has five fingers extended, trace each child's hand on the chalkboard. Label each tracing with the child's name. Thank the children for their helping hands, and encourage them to remember and obey their own family rules.

3. Do the following finger play with the children:

I stop (*hold both hands up, palms forward as if to stop something*),
I look (*put hand over eyes as if to shade them*),
I listen (*cup hand behind ear*),
And then I'm sure to know (*wave finger back and forth*)
That I (*point to self*) am acting safely,
No matter where I go (*spread arms outward to indicate space*).
I only cross at crossings (*cross arms across chest*),
Not halfway up the street (*shake head*);
I look ahead (*put hand over eyes as if to shade them*),
I think ahead (*tap side of head*),
And then I use my feet (*walk in place*).

Remind the children of the importance of obeying traffic laws.

Purpose

To help the children understand that they can follow the example of Jesus Christ and show love by helping others.

Preparation

1. Prayerfully study Mark 6:34–44; Luke 17:11–19; John 13:15, 34–35; and 3 Nephi 17.
2. Cut a large heart out of paper for the attention activity.
3. For each child, make a copy or tracing of the “As I Have Loved You” handout and heart puzzle found at the end of the lesson. If possible, copy or trace the puzzles onto colored paper. Cut the puzzles into pieces along the dotted lines.
4. Prepare to sing or say the words to “Love One Another” (*Children’s Songbook*, p. 136) and “Jesus Said Love Everyone” (*Children’s Songbook*, p. 61). The words to “Love One Another” are included at the back of the manual.
5. Materials needed:
 - a. A Bible and a Book of Mormon.
 - b. Glue or paste.
 - c. Picture 2-36, Jesus Blessing the Nephite Children; picture 2-45, Ten Lepers (Gospel Art Picture Kit 221; 62150); picture 2-47, Feeding the Five Thousand (62143); picture 2-54, The Last Supper (Gospel Art Picture Kit 225; 62174).
6. Make the necessary preparations for any enrichment activities you want to use.

Suggested

Lesson

Development

Invite a child to give the opening prayer.

Follow up with the children if you encouraged them to do something during the week.

It Is Important to Be Loved

Attention activity

Show the large paper heart to the children.

- What do you think of when you see a heart? (Love.)
- How can you tell someone loves you?

Let the children talk about people who love them (such as family members, friends, and Primary teachers) and how those people show their love.

- How do you feel when people show they love you?
- How do you think other people feel when you show you love them?

Point out that we all need to know we are loved.

Jesus Christ Taught Us to Love One Another

Teacher presentation	Explain that before Jesus Christ lived on the earth, people lived by the rule “an eye for an eye.” This meant that if people were mean or unfriendly to you, you could be mean or unfriendly to them. Explain that when Jesus came to the earth, he taught people a different way to live.
Scripture story	<p>Show picture 2-54, The Last Supper. Explain that just before Jesus was crucified, he met with his disciples and they ate their last meal together. This meal became known as the Last Supper. During this meal the Savior told his disciples that he would soon leave them, and he gave them some instructions.</p> <p>Show the Bible and read aloud John 13:34–35. Explain that these are Jesus’ words. Read again the first part of verse 34 (through the first <i>love one another</i>).</p> <ul style="list-style-type: none">• What is a commandment? <p>Point out that in this scripture Jesus did not merely suggest that we love one another; he gave us a commandment to love each other. If we follow Jesus, we will love others.</p>
Song	<p>Sing or say the words to “Jesus Said Love Everyone,” using the actions indicated:</p> <p>Jesus said love ev’ryone (<i>outstretch arms</i>); Treat them kindly, too (<i>turn to neighbor and shake hands</i>). When your heart is filled with love (<i>place hands on heart</i>), Others will love you (<i>hug self</i>).</p>

Jesus Christ Showed Love for Others by Helping Them

Scripture	<p>Read aloud John 13:15.</p> <ul style="list-style-type: none">• What does it mean to be an example?• Who has set a good example for us? <p>Tell the children that Jesus Christ said the words in the scripture you just read. Explain that one way Jesus set an example for us was by loving other people and doing kind things for them.</p>
Scripture stories and discussion	<p>Show picture 2-45, Ten Lepers. Ask the children to tell the story illustrated by the picture (see Luke 17:11–19).</p> <ul style="list-style-type: none">• What did Jesus do to help the ten lepers?• Why did he heal them? <p>Show picture 2-47, Feeding the Five Thousand, and ask the children to tell the story illustrated by the picture (see Mark 6:34–44). Help them if necessary.</p> <ul style="list-style-type: none">• What did Jesus do to help the people?• Why did he help them? <p>Show picture 2-36, Jesus Blessing the Nephite Children, and tell the story found in 3 Nephi 17. Explain that Jesus was ready to leave the Nephites in America and go back to Heavenly Father, but the Nephites did not want him to leave (see 3 Nephi 17:4–5). Jesus stayed a little longer and healed all the sick people and blessed all the children.</p>

- Why did Jesus stay with the Nephites?
- Why did Jesus heal the sick and bless the children?

Point out that in each of these stories, Jesus Christ helped people because he loved them. We can also show people that we love them by helping them.

We Can Follow Jesus Christ's Example by Helping Others

Scripture	Read again John 13:35. Explain that as we show our love for other people, they will know that we follow Jesus Christ's example.
Song	Sing or say the words to "Love One Another."
Story	<p>Explain that we can follow the example of Jesus Christ and show our love for others by helping them. Tell a story about a child who did something kind for someone to show love for that person. You may want to use the following story:</p> <p>Tomás became very sick and had to stay in bed for a long time. He missed doing all the fun things he and his friends liked to do. While he was sick, some of his friends came to visit him once or twice. But his friend Juan came to visit him often. Many times when the other boys were outside playing, Juan was at Tomás's bedside talking and laughing with Tomás and helping him feel better.</p> <ul style="list-style-type: none"> • What did Juan do to show that he loved Tomás? • How do you think Tomás felt about Juan? How do you think Juan felt about Tomás? <p>Explain that there are many ways we can show our love for others by helping them. We can do kind things for our families, our friends, our neighbors, older people, those who are ill, or anyone else who needs our help.</p>
Activity	<p>Have the children listen as you tell them the first part of a situation that could happen to them. Ask them to finish each situation by telling what they would do to show love. You may want to have the children role-play one or more of the situations. Use the following situations or create some of your own:</p> <ol style="list-style-type: none"> 1. You and your father are sitting on the corner waiting for the bus to come. You see an older man hurrying to catch the bus. He has a cane to help him walk, but he can't move very fast. The bus pulls up and the door opens. As you climb up the steps, you can tell he probably won't reach the bus in time. <ul style="list-style-type: none"> • What could you do to show love for this man? 2. On Sunday morning you are walking to church. You see a young mother with her baby in one arm and some books in the other. <ul style="list-style-type: none"> • What could you do to follow the example of the Savior and show love for this woman? 3. When you arrive home from school, your mother is trying to sew. Your little brother is fussing and crying because he wants your mother to read him a story. <ul style="list-style-type: none"> • What could you do to show love for your mother and your little brother? 4. One Sunday in Primary, you meet a new girl from another country. She is very shy and doesn't talk much. Later you see her standing by the front door of the meetinghouse crying. <ul style="list-style-type: none"> • What could you do to show love and help the new girl?

Summary

Puzzle activity

Give each child one of the heart handouts and a set of heart puzzle pieces. Help each child put the puzzle together and then glue the puzzle onto the heart handout. With the children, say the words on the puzzle and handout aloud.

Let the children take their handouts home. Encourage the children to tell their families what they learned today about showing love for others.

If time allows, ask each child to name a person he or she loves and tell one way he or she could show love for that person. Encourage the children to show love for others by helping them.

Testimony

Testify that Heavenly Father and Jesus Christ want us to love each other. Tell the children how you feel when you show love for others.

Invite a child to give the closing prayer. Suggest that the child ask Heavenly Father to help the children show love for others as the Savior did.

Enrichment Activities

Choose from the following activities those that will work best for the children in your class. You can use them in the lesson itself or as a review or summary. For additional guidance, see “Class Time” in “Helps for the Teacher.”

1. Have the children each write a letter to someone they love, explaining how much they care for that person. Younger children may draw pictures for people they love. Encourage the children to share their letters or drawings with the people for whom they made them.
2. Tell the following story about a time when John Taylor, who became the third President of the Church, showed love:

When John Taylor was a young boy, his friend Robert West died from a serious illness. Afterward the boy’s father, Allee West, moved from the village to become a shepherd. John knew that Allee was sometimes lonely, so he asked his parents if he could visit Allee. John’s parents gave their permission and fixed a basket of food for John to take along.

It took all day for John to walk to Allee’s house and back, so he left early in the morning. The trip was tiring, and there were many hills to cross. Once, while resting, John was tempted to eat the food in the basket. He got up instead and walked the rest of the way as quickly as possible.

Allee was overjoyed to see John. They ate the food together and talked of old times. (See Deta Petersen Neeley and Nathan Glen Neeley, *A Child’s Story of the Prophet John Taylor* [Salt Lake City: Deseret News Press, 1960], pp. 12–18.)

- What did John Taylor do to show love for the father of his friend?
- How do you think Allee West felt about what John Taylor did?
- How do you think John Taylor felt?

Remind the children that when we show love for others, the people we help are happy and we are happy too.

3. Help the children say the words and do the actions to the following activity verse:

Jesus Loves All Children

Jesus loves all children (*hold arms outstretched*),
The little ones still small (*use hand to indicate knee-high child*),
The baby in the cradle (*form cradle with arms*),
The ones so big and tall (*raise hands high over head*).

(From *Finger Fun for Little Folk* by Thea Cannon. © 1949 by the Standard Publishing Company, Cincinnati, Ohio. Used by permission.)

Repeat as many times as the children want.

4. Have two children stand in front of the class. Discuss with the class the many ways these two children are similar, such as having two eyes and two ears, liking to do the same things, or being members of the Church. Then discuss the many ways they are different, such as having different hair colors, different hobbies, or different family sizes. Point out that no two people are exactly alike. All of us are different in some way from everyone else.

Explain that sometimes people are different in ways that make us unsure how to treat them. They may speak a different language, have a disability, or be different from us in some other way. Explain that Jesus Christ loves everyone, and he wants us to love everyone also. We should love and help those who seem different from us as well as those who seem like us.

You may want to have the children sing or say the words to "I'll Walk with You" (*Children's Songbook*, p. 140) or "We Are Different" (*Children's Songbook*, p. 263).

I'll Walk with You

If you don't walk as most people do,
Some people walk away from you,
But I won't! I won't!
If you don't talk as most people do,
Some people talk and laugh at you,
But I won't! I won't!
I'll walk with you. I'll talk with you.
That's how I'll show my love for you.

Jesus walked away from none.
He gave his love to ev'ryone.
So I will! I will!
Jesus blessed all he could see,
Then turned and said, "Come, follow me."
And I will! I will!
I will! I will!
I'll walk with you. I'll talk with you.
That's how I'll show my love for you.

We Are Different

I know you, and you know me.
We are as diff'rent as the sun and the sea.
I know you, and you know me,
And that's the way it is supposed to be.

I help you, and you help me.
We learn from problems, and we're starting to see.
I help you, and you help me,
And that's the way it is supposed to be.

I love you, and you love me.
We reach together for the best we can be.
I love you, and you love me,
And that's the way it is supposed to be.

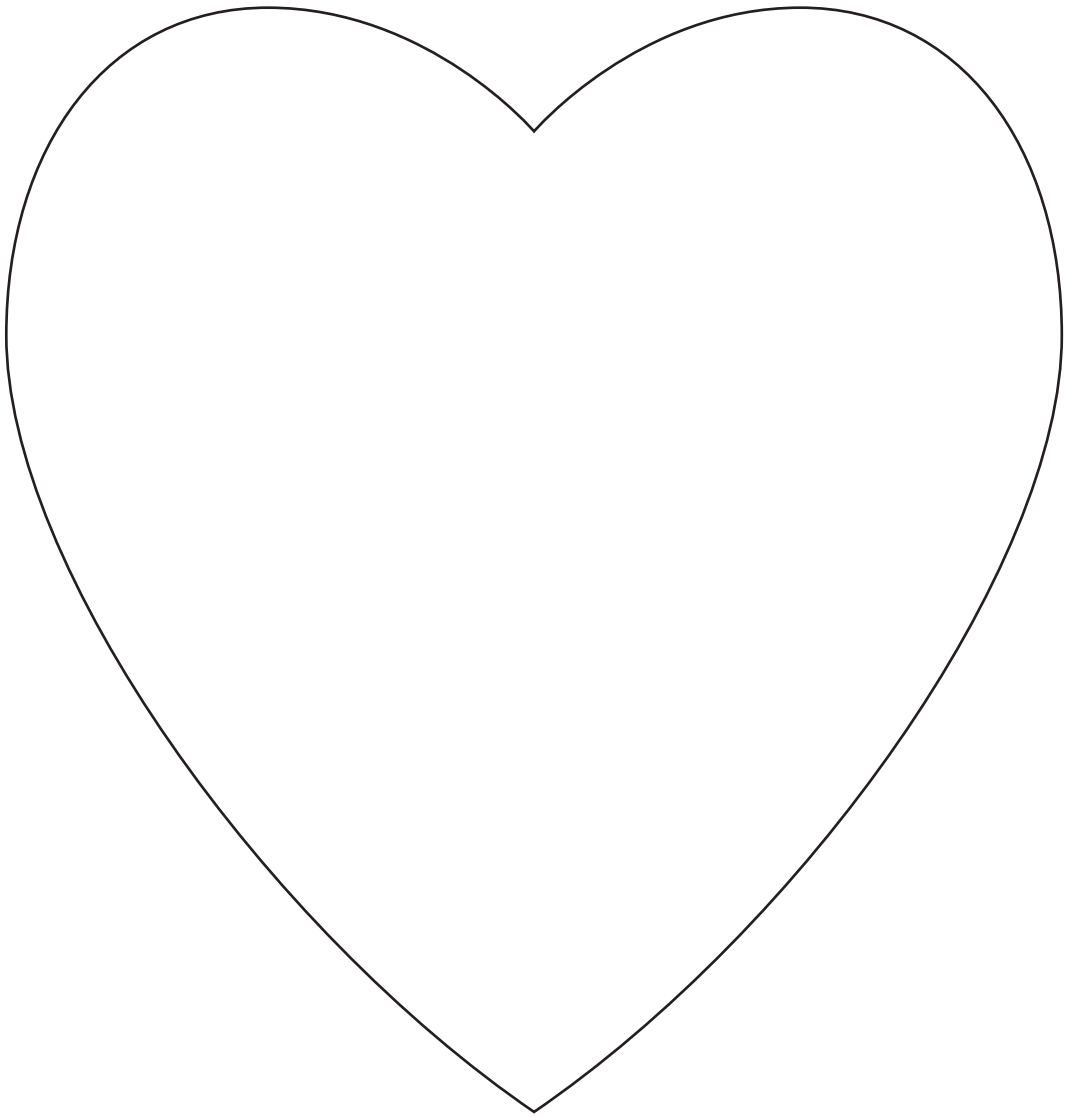

As I Have
Loved You

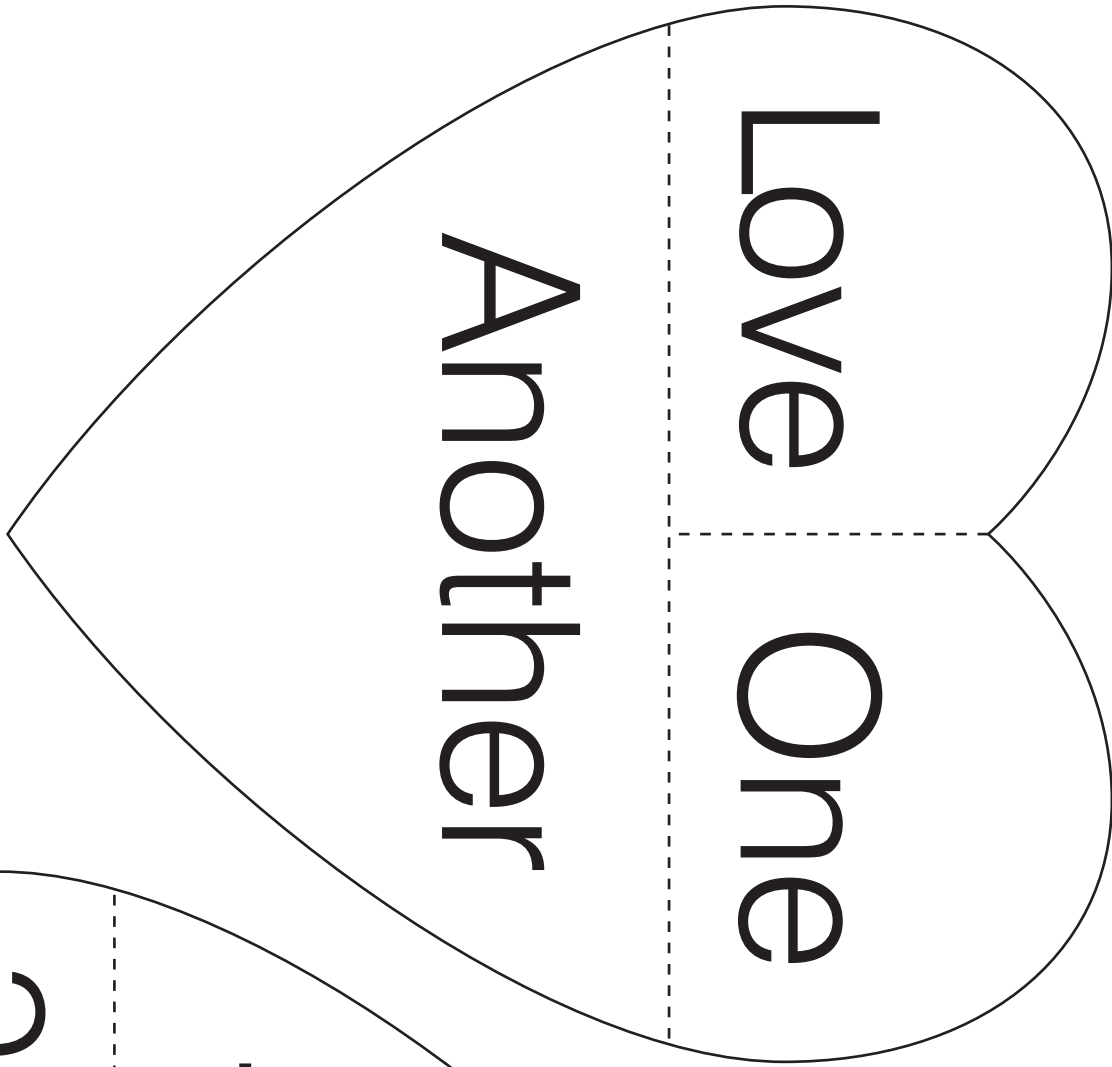

Use this puzzle for younger children.

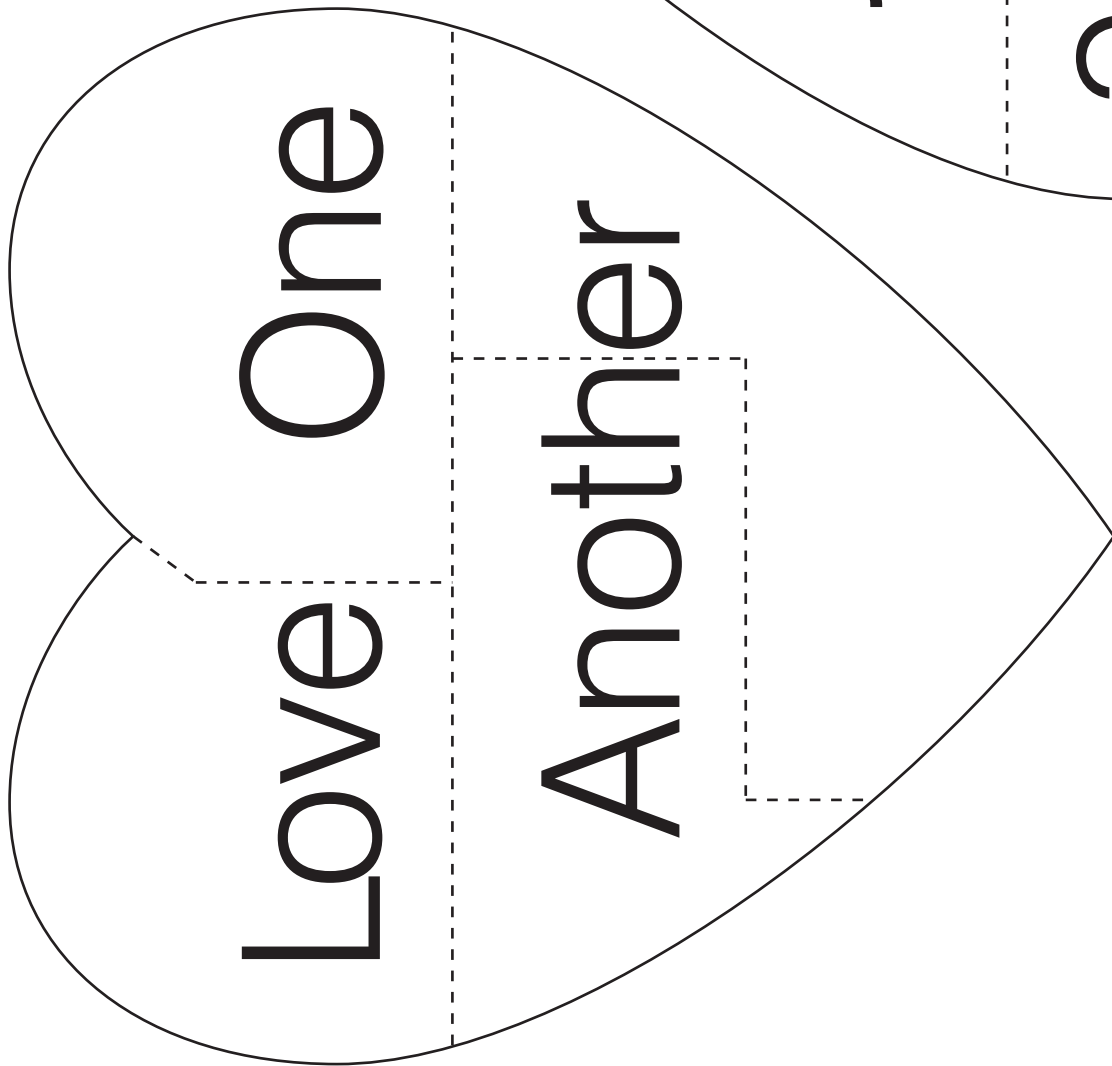

Use this puzzle for older children.

Purpose

To help each child understand that we show love for Heavenly Father and Jesus Christ when we pay tithing.

Preparation

1. Prayerfully study Mark 12:41–44. See also *Gospel Principles* (31110), chapter 32, and pages 561–62 of James E. Talmage’s *Jesus the Christ*, 3rd ed. [Salt Lake City: The Church of Jesus Christ of Latter-day Saints, 1916].
2. Prepare two signs using folded pieces of paper, as shown:



3. Make a money box to illustrate the story about Mark. You can use any small box with a lid, divided into two sections. See the following instructions and illustrations to make a divider, if necessary.

Cut a strip of cardboard the same height as the box but one inch (or three centimeters) wider than the box. Mark one-half inch (or one-and-a-half centimeters) at each side and fold the sides over to make tabs. Apply glue to the tabs and insert the cardboard strip into the box to make two sections, one larger than the other.

On the front of the box or on the lid, print “Tithing” on the small section and “To Spend or Save” on the large section.

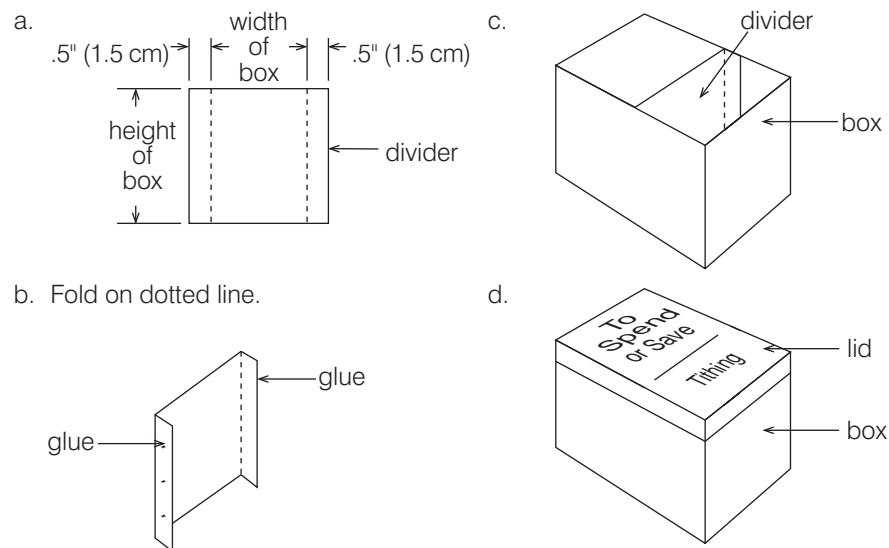

- Cut from brown paper two circles the size of small coins called mites, as illustrated:

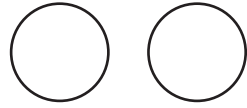

- Obtain a Tithing and Other Offerings slip and a tithing envelope for each child.
- Prepare to sing or say the words to "I Want to Give the Lord My Tenth" (*Children's Songbook*, p. 150).
- Materials needed:
 - A Bible.
 - Ten coins (or bills) of equal value.
 - Picture 2-55, The Widow's Mite.
- Make the necessary preparations for any enrichment activities you want to use.

**Suggested
Lesson
Development**

Invite a child to give the opening prayer.

Follow up with the children if you encouraged them to do something during the week.

Tithing Is One-Tenth of What We Earn

Attention activity

Hold the ten coins in your hand and show them to the children.

- What would you do with these coins if you had earned them?

Let each child respond, and make positive comments about each answer. There are no right or wrong answers. When each child has responded, continue the discussion.

If a child mentioned paying tithing, comment that someone mentioned something very important that we should do when we earn money. If no one mentioned paying tithing, tell the children that you would like to help them learn about something very important to do whenever they earn some money.

Explain that Heavenly Father has commanded us to pay tithing on the money we earn. When we pay tithing, we give some of the money we have earned to the Church to help pay for things that help people learn about Heavenly Father and Jesus and the gospel, such as temples, church buildings, lesson manuals, and other materials.

Activity

Have the children count the ten coins with you as you place the coins on the table or floor in a row. Put the sign labeled "Tithing" on the table or floor. Read or have the children read the word on the sign. Tell the children that one-tenth of the money we earn is the amount we pay as tithing. One coin out of the ten on the table or floor would be one-tenth. Ask a child to put one coin in front of the tithing sign.

Put the sign labeled "To Spend or Save" next to the "Tithing" sign. Read or have the children read the words on the sign.

- If this were money you had earned, how many coins would you have left to spend or save after paying tithing?

Have a child put nine coins in front of the “To Spend or Save” sign, one at a time, as the class counts them.

Point to the coins in front of the “To Spend or Save” sign and explain that the money we pay in tithing is a small portion of the money we earn.

Explain that we should pay tithing on all money we earn. You may want to use different coins or bills to help the children further understand the idea of paying one-tenth of the money they earn as tithing.

We Choose the Right When We Pay Tithing

Story

Put nine coins in the “To Spend or Save” side of the money box and tell in your own words the story of Mark and his choice to pay his tithing. You may want to substitute the name of the coins you brought for the word *coin* as you tell the story.

The last time Mark was at the store he had seen a toy he wanted to buy. Mark had been working for his mother and saving money to buy the toy. He had earned nine coins. He needed only one more coin to buy the toy. His mother told him that she would pay him if he did a job for her.

Early Saturday morning Mark got up and ate his breakfast, then did the job his mother wanted him to do. When he was finished, his mother told him that she was very pleased with the work he had done. She gave Mark a shiny new coin. Mark was excited because now he had enough money to buy the toy.

Mark ran to get his money box, and he dropped the coin inside. (Place another coin in the “To Spend or Save” side of the box.) Then he and his mother went to the store.

When they got to the store, Mark found the toy. He was happy it hadn't been sold. He looked at it very carefully. He could hardly wait to play with it.

When Mark went to pay for the toy, the clerk smiled and said that it would cost ten coins. Mark took the lid off his money box and started to count out his coins. (Take the lid off the money box, and count out the coins from the “To Spend or Save” side.) When he got to ten he remembered: one coin out of ten should be tithing.

Mark didn't know what to do. He really wanted the toy. He could have it, but only if he gave the clerk his tithing money. Mark looked at the clerk, at the toy, and then at the tithing coin.

- What would you do if you were Mark?

Mark dropped the tithing coin in the tithing side of the box. (Put a coin in the “Tithing” side of the box.) He put the nine coins back in the “To Spend or Save” side of the box and walked down the aisle to put the toy back on the shelf.

Mark's mother didn't say anything, but she put her arm around Mark and gave him a tight squeeze. Mark knew he had done the right thing.

The next day at church, Mark gave his tithing envelope to the bishop. The bishop shook Mark's hand and told Mark that Heavenly Father was happy that he paid his tithing. Mark was happy too. He knew he had made the right choice. (Adapted from Marshall T. Burton, “The Little Red Car,” *Instructor*, Apr. 1966, pp. 158–59.)

- Discussion
- What choice did Mark have to make?
 - Why was this a difficult choice for him?
 - How did Mark feel about the choice he made? Why?
 - Who else was happy about Mark's choice?

Paying Tithing Shows Love for Heavenly Father and Jesus Christ

Discussion Explain that we show our love for Heavenly Father and Jesus Christ when we pay tithing.

- What blessings have Heavenly Father and Jesus Christ given you?

Point out that one coin out of ten is not much to give to thank Heavenly Father and Jesus for the many blessings they have given us.

Scripture story Show the brown paper circles to the children, pointing out how small the circles are. Explain that these circles are the same size as coins called mites, which were used when Jesus Christ was on the earth. Mites were not worth very much.

Show picture 2-55, The Widow's Mite, and explain that even though mites were very small and not worth very much, a woman used them to show love for Heavenly Father. Tell the story found in Mark 12:41–44.

Explain that in Jesus Christ's time, tithing and offerings were collected at the temple in large containers with openings at the top. (Point out the container in the picture.) One day Jesus watched the people as they came and put their money in the container. When Jesus saw the widow put in her money, he called over his disciples. He told the disciples that the widow had done a great deed because she loved Heavenly Father enough to give even though she did not have very much money.

Teacher presentation Read aloud from Mark 12:43 what Jesus told the disciples. Explain that the widow had given only a small amount compared to the amounts that some rich people paid, but Jesus knew that she gave what she had because she loved Heavenly Father. We too can show our love for Heavenly Father and Jesus Christ by paying our tithing, even if it is just a small amount.

Remind the children how Mark showed his love for Heavenly Father and Jesus by choosing to pay his tithing instead of buying the toy. It was difficult for Mark, but he felt happy when he made the right choice.

Song Help the children sing or say the words to "I Want to Give the Lord My Tenth." Repeat the song a few times so the children can learn the words.

I want to give the Lord my tenth,
For ev'ry time I do
It makes me think of all the gifts
He gives to me and you.

He gives us life, this lovely world.
And though my tenth seems small,
It shows my faith and gratitude
To him, the Lord of all.

Remind the children that when we pay our tithing, we show how much we love Heavenly Father and Jesus Christ.

How We Pay Tithing

Activity	<p>Remind the children that when Jesus was on the earth, the people put their tithing and other offerings of money into containers at the temple. Explain that today we pay our tithing to the bishop (or branch president) or one of his counselors.</p> <p>Give a Tithing and Other Offerings slip and a tithing envelope to each child. Explain that we use these forms and envelopes when we pay our tithing. Show the children how to fill out the form. If the children are interested, briefly explain the other donation categories listed on the form. Explain that we put the form and the money in the envelope and give it to our bishop (or branch president) or one of his counselors.</p>
	<h3>Summary</h3>
Review	<p>Show the ten coins again.</p> <ul style="list-style-type: none">• If you earned these ten coins, how much tithing would you put in the envelope? <p>Have a child take the proper amount and put it in an envelope with the form.</p> <ul style="list-style-type: none">• What do we do with the tithing envelope?
Testimony	<p>Bear your testimony about how we show love for Heavenly Father and Jesus Christ by paying our tithing.</p> <p>Encourage the children to pay tithing on any money they earn, no matter how small the amount.</p> <p>Invite a child to give the closing prayer.</p>

Enrichment Activities

Choose from the following activities those that will work best for the children in your class. You can use them in the lesson itself or as a review or summary. For additional guidance, see “Class Time” in “Helps for the Teacher.”

1. Discuss with the children some of the things tithing money is used for, such as building temples and meetinghouses, doing missionary work, and printing lesson manuals. Discuss how these things benefit us and others.

Give the children paper and crayons or pencils, and let each child draw a picture of one of the things you have discussed.

2. Sing or say the words to “I’m Glad to Pay a Tithing” (*Children’s Songbook*, p. 150).

My Heav’nly Father gives me all good and lovely things:
The sun that shines, the rain that falls, the meadowlark that sings.

I’m glad to pay a tithing, one-tenth of all I earn;
It’s little when I think of all God gives me in return.

Talk about the importance of having the right attitude when obeying the law of tithing, as with any other commandment that our Heavenly Father gives us.

3. Let each child decorate a container, such as a box, can, or envelope, for tithing. Bring the containers yourself or contact the children during the week before this lesson to ask them to bring their own containers.

Always Tell the Truth

Lesson
34

Purpose To strengthen each child's desire to tell the truth, even when it is not easy.

Preparation

1. Prayerfully study Mark 14:53–65 and Articles of Faith 1:13. See also *Gospel Principles* (31110), chapter 31.
2. Prepare to sing or say the words to "To Show I Choose the Right" (sung to the tune of "If You're Happy," *Children's Songbook*, p. 266).
3. Materials needed:
 - a. A Bible.
 - b. A bottle that the children can spin, such as a soft-drink bottle.
 - c. CTR chart (see lesson 1).
 - d. Picture 2-56, The Trial of Jesus.
4. Make the necessary preparations for any enrichment activities you want to use.

**Suggested
Lesson
Development**

Invite a child to give the opening prayer.

Follow up with the children if you encouraged them to do something during the week.

We Can Tell the Truth

Attention activity

Tell the following story in your own words:

One day Ann-Marie went fishing with her grandpa. Ann-Marie had a good time and was especially happy when she caught a fish.

When Ann-Marie got home, she went to see her friend Danny. He invited her inside and took her into the kitchen, where he showed her a fish that he had caught. Danny's fish was much bigger than the fish Ann-Marie had caught.

Ann-Marie was happy for Danny, but she also felt disappointed. Compared to Danny's fish, her fish was very small. She didn't want Danny to know how bad she felt, so she told him that she went fishing with her grandpa and caught a fish so big that she and her grandpa had to use a net to help pull it in. Ann-Marie told Danny that her fish was much bigger than his.

Discussion

- What did Ann-Marie do that was wrong?
- What should Ann-Marie have done?
- What does it mean to tell the truth?

Explain that telling the truth is part of being honest. When we tell the truth, we tell about things exactly as they happened.

- Why is it important to tell the truth?

You may want to ask the children to tell about times when they have told the truth.

Article of faith

Remind the children that the Articles of Faith are statements of what Church members believe. Tell the children that part of the thirteenth article of faith says, "We believe in being honest [and] true." Have them repeat the phrase a few times.

Jesus Christ Told the Truth

Scripture story

Display picture 2-56, The Trial of Jesus. Leave the picture up for the rest of the lesson. Tell the children that Jesus Christ always told the truth, and tell the story found in Mark 14:53–65.

Explain that the soldiers took Jesus to the home of the Jewish high priest, where the Jewish leaders asked him many questions. Read aloud from Mark 14:61 one of the questions they asked him: "Art thou the Christ?"

Explain that Jesus knew that if he said he was the Christ, the special Son of Heavenly Father, the leaders would not let him go. Read aloud from Mark 14:62 what Jesus said when he answered the high priest: "And Jesus said, I am." Point out that Jesus always told the truth, even when his life was in danger.

Explain that Jesus wants us to tell the truth always, even when it is hard to do so.

CTR chart

Point to the CTR chart and have the children repeat the words on it. Then have the children repeat after you, "I will follow Jesus Christ and tell the truth."

Song

Help the children sing or say the words to "To Show I Choose the Right."

To show I choose the right, I tell the truth.
To show I choose the right, I tell the truth.
I know the Savior's way,
And it shows in what I say.
To show I choose the right, I tell the truth.

Sing or say the words a few times to help the children learn them.

We Can Tell the Truth Even When It Is Not Easy

Discussion

Point out that it is not always easy to tell the truth. Sometimes it is easier for us to say something that is not true or to not say anything at all.

- Why is it sometimes hard to tell the truth? (Answers may include because we don't want to make someone angry or because we might be punished.)

Story

Tell a story about a child who did not tell the truth and felt sorry about it. You may want to use the following story:

JoAnne had accidentally broken her mother's sewing scissors. She had hidden them in a drawer so her mother wouldn't know who had broken them. JoAnne's mother was looking for the scissors, and she asked if anyone had seen them. JoAnne told her mother that she had not seen the scissors.

JoAnne felt bad after she said that. She knew she had done wrong by playing with the scissors when she wasn't supposed to, and now she had done a second wrong thing by lying about it. JoAnne felt sick.

When JoAnne came to family prayer, she quickly closed her eyes. She didn't want to look at her mother. As JoAnne's father said the prayer, JoAnne heard

him say, "Give us the courage to do what is right, that we might have peace of mind and joy forever." JoAnne knew that to be happy again she needed to tell her mother the truth about the scissors.

JoAnne brought the broken scissors to her mother and told her mother the truth. She was sorry that she had broken the scissors and lied, and she wanted to do the right thing. (Adapted from Margery Cannon, "A Miss and a Mistake," *Children's Friend*, Mar. 1962, p. 14.)

Discussion

- Did JoAnne tell the truth when her mother first asked her about the scissors?
- How did JoAnne feel when she did not tell the truth?
- How do you think JoAnne felt when she did tell her mother the truth?
- Was it easy for JoAnne to tell the truth?

Explain that even though it was hard for JoAnne to tell the truth because she was afraid she would be punished for breaking the scissors, she was happier when she told the truth.

Game

Play the game "Tell the Truth" with the children. Have the children sit in a circle, and place the bottle on the floor in the center of the circle. Explain that you will spin the bottle, and the child it points to will have a chance to answer a question about telling the truth. After answering, the child will spin the bottle to choose the next person. (If the bottle points to a child who has already answered a question, have the child spin it again.)

Use the following situations and questions for the game, or create some situations more appropriate for the children in your class (if your class is large, you may need to add more situations):

1. You are playing in your home and you accidentally break a lamp.
 - What should you do?
2. Your father asks you to hurry to the store and buy something he needs. He asks you not to stop and play on the way. As you pass your neighbor's house, she gives you some letters to mail for her. On the way home from the store, you stop to see a friend's new bicycle. Suddenly you remember that your father is waiting, and you hurry home. Your father is upset, and you want to tell him that you are late because you mailed some letters for the neighbor.
 - What should you say?
3. You see a plate of cookies on the table. They look so good that you take one for yourself and give one to your little brother. When your mother comes to take the cookies to her friend, she sees your brother eating a cookie and starts to scold him.
 - What should you do?
4. You take one of your little sister's toys away from her, and she starts to cry. When you hear your grandmother coming, you quickly give the toy back, but your little sister will not stop crying. Your grandmother asks you why your sister is crying.
 - What should you say?

5. You and your friends are playing ball in front of a neighbor's house. You kick the ball, and it knocks over and breaks a flowerpot by your neighbor's door.
- What should you do?

Summary

Testimony

Bear your testimony about the importance of being truthful, even when it is hard. Remind the children that Jesus Christ always told the truth and that he wants us to always tell the truth. You may want to tell about a time when you were glad you told the truth, even though it was hard for you to do so.

Remind the children that they should always try to choose the right. When they tell the truth, they are choosing the right.

Encourage the children to tell their families about what they learned in Primary today.

Invite a child to give the closing prayer. Suggest that the child ask Heavenly Father to help each class member tell the truth, even when it is not easy.

Enrichment Activities

Choose from the following activities those that will work best for the children in your class. You can use them in the lesson itself or as a review or summary. For additional guidance, see "Class Time" in "Helps for the Teacher."

1. Sing or say the words to "Dare to Do Right" (*Children's Songbook*, p. 158), "Choose the Right Way" (*Children's Songbook*, p. 160), or "I Believe in Being Honest" (*Children's Songbook*, p. 149). The words to "Dare to Do Right" and "Choose the Right Way" are included at the back of the manual.

I Believe in Being Honest

I believe in being honest;
I believe in being true,
That honesty should start with me
In all I say, in all I do.

I'll form good habits in my youth,
To keep my word, to tell the truth,
To speak up in defending right
And keep my name and honor bright.

I believe in being honest;
I believe in being true,
That honesty should start with me
In all I say, in all I do.

2. Ask a child to come to the front of the class and hold up both hands. Loosely wrap a piece of thread or yarn around the child's wrists and hold it securely. Explain that the thread or yarn is like a little lie. Ask the child to break free (hold the thread or yarn loosely enough that the child can break free).

Then wrap the child's wrists a dozen or so times as you explain that one lie can lead to many more as we try to cover up our lies. When we lie, we often have to tell more lies to keep people from finding out that we lied. When we tell many lies, it is more difficult to free ourselves. Ask the child to break free

now. If the child succeeds, you may want to try with even more layers of thread or yarn. Explain that the more we lie, the harder it becomes to choose the right and tell the truth.

- How can you break free from these lies?

Use a pair of scissors to cut through the thread and free the child's hands. Explain that to be free of lies, we must always tell the truth. If we have already told a lie, we must repent by telling the truth to the person we lied to. When we tell the truth, we can be happy.

3. Prepare for each child a copy of the "secret message" found at the end of the lesson. Give each child a copy of the message and a pencil. Explain that one of Jesus Christ's teachings is in the secret message. Tell the children they can discover the secret message by finding the letter that goes with each symbol and writing it in the box underneath the symbol. Write in one letter as an example and help the children as needed.

Ask the children to fold their arms and smile when they know what the secret message is. When all the children have discovered the message, have them read the words of the secret message together with you: "Tell the truth."

4. Have the children act out some of the "Tell the Truth" game situations used in the lesson, demonstrating the right choice in each situation.

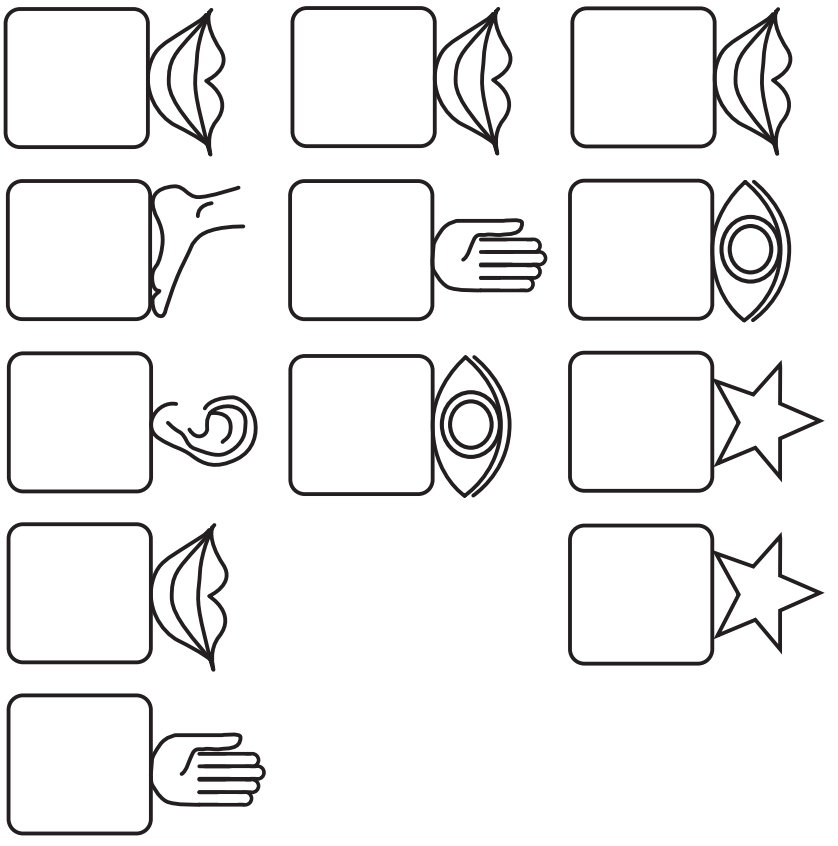
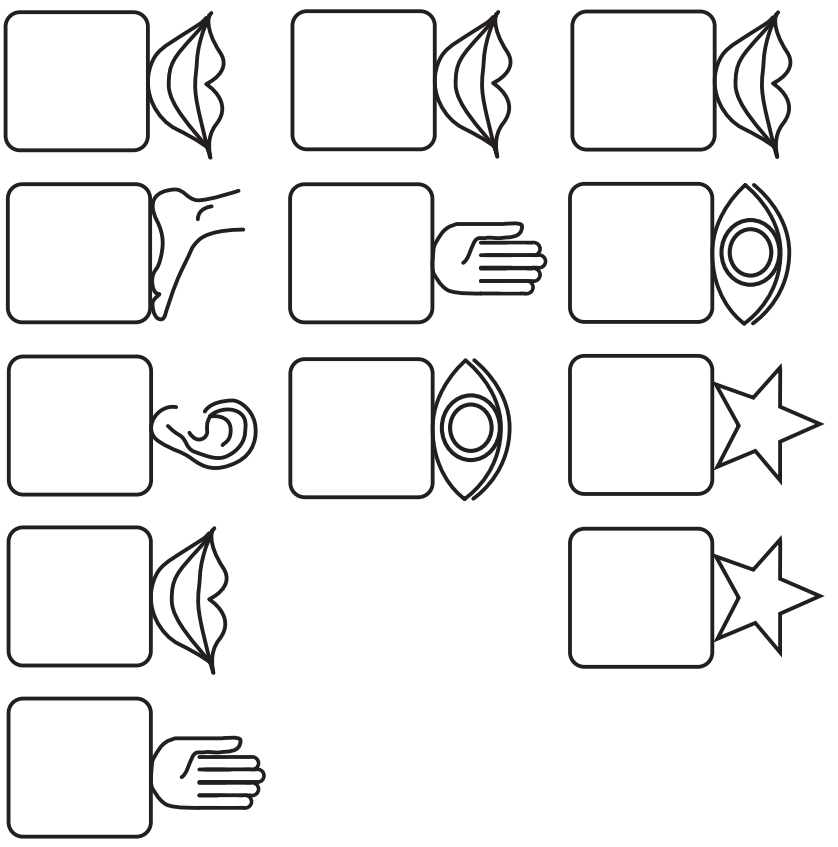
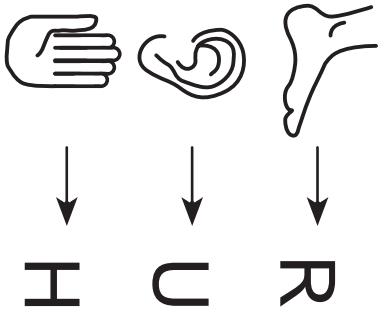
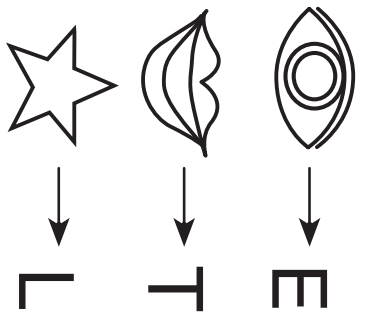
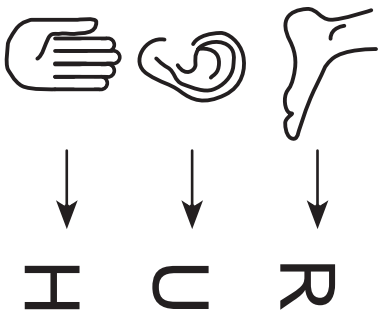
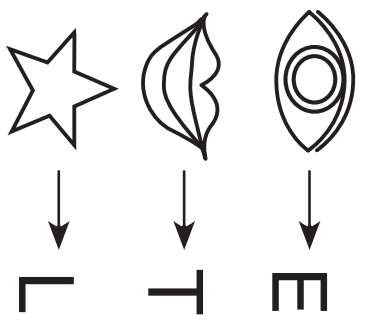

I Have Talents

Lesson
35

Purpose To help each child recognize that Heavenly Father has given each of us talents.

- Preparation**
1. Prayerfully study Matthew 25:14–29. See also *Gospel Principles* (31110), chapter 34.
 2. During the week, contact each child’s parents and ask them what talents they have observed in their child. If necessary, suggest some less obvious talents, such as being kind, cheerful, obedient, helpful, forgiving, friendly, or prayerful. Make a list of talents for each child. Add to the lists the talents you have observed in each child.
 3. Using your list, prepare a paper similar to the following for each child. Write the child’s name on a piece of paper. Fold the paper in half. On one half list the child’s talents that you will discuss during the lesson. Leave the other half of the paper blank.

<p>(Child’s name)</p> <p>Ask me about my talents:</p> <ol style="list-style-type: none">1.2.3.4.5.	
--	--

Make sure that each child’s paper has the same number of talents listed and that each child’s list contains at least one talent that can be demonstrated, such as singing, skipping, or reading.

4. Prepare to demonstrate one of your talents, or bring an item that represents one of your talents.
5. Materials needed:
 - a. A Bible.
 - b. Crayons or pencils.
 - c. Picture 2-57, Heber J. Grant.
6. Make the necessary preparations for any enrichment activities you want to use.

**Suggested
Lesson
Development**

Invite a child to give the opening prayer.

Follow up with the children if you encouraged them to do something during the week.

Talents Are Gifts from Heavenly Father

Attention activity

Demonstrate one of your talents, or show the item you brought and explain that it represents one of your talents.

- What is a talent?

If you brought an item, tell about the item and explain why the talent it represents is important to you. If you demonstrated a talent, explain why you enjoy using that talent.

Explain that Heavenly Father has given talents to each of his children. Mention some people in your ward or branch who have talents the children are familiar with, such as singing, playing a musical instrument, or helping others feel happy.

Remind the children that each of them is a child of Heavenly Father, so each of them has talents also. Explain that everyone has different talents.

Each of Us Has Many Different Talents

Story and
discussion

In your own words, tell the following story of a child who discovered that she had talents:

Wendy watched her sister Shelley draw a beautiful picture of the mountains behind their home. Wendy was discouraged because she couldn't draw as well as Shelley did. Shelley played the piano too and was smart in school. Wendy thought about all the things that Shelley could do well. She wondered why she couldn't do those things well also.

- How do you think Wendy felt when she thought about all of Shelley's talents?

One day Wendy's teacher asked her to give a talk in Primary. She worked hard on it and gave a good talk. The bishop heard Wendy's talk and told her how much he enjoyed her talk. He told Wendy that she was very talented.

A warm feeling came over Wendy. The bishop's words helped Wendy discover something important about herself.

- What did the bishop help Wendy discover? (She had a talent for giving good talks.)

Wendy soon discovered that she had other talents too. She made friends easily, and other children always wanted to be with her. She loved to read and write. When she went to church, she was reverent and listened to her teacher. Wendy had never thought that these were talents because they were not like Shelley's talents. Now Wendy realized that she did have talents, but her talents were different from her sister's.

- What talents did Wendy have?

Emphasize to the children that everyone has different talents, but all talents are important.

Activity	<p>Tell the children that they are going to learn about the many different talents of the people in their Primary class. Ask the children to listen carefully as you read each list of talents. Tell the children that when they know who you are describing, they should raise their hands but not say anything out loud.</p> <p>Beginning with “I’m thinking of someone who has these talents,” read the list of talents you have prepared for each child.</p> <p>When you have finished reading each list, let the children guess which child you have just described. If the children cannot guess correctly, give some obvious clues, such as describing the clothes the child is wearing or telling whether the child is a girl or a boy.</p>
Talent demonstration	<p>Remind the children that Heavenly Father has given them these talents. Invite each child to demonstrate a talent from his or her list. (Decide ahead of time which talents on each child’s list could be easily demonstrated in class, such as singing a favorite song, reading, skipping, or hopping.)</p>
Jesus Christ Taught Us to Use Our Talents	
Scripture story	<p>Tell the children that Jesus Christ taught that we should use our talents. Briefly tell the story found in Matthew 25:14–29. Explain that Jesus told this story to his disciples to help them understand what they must do to live with him and Heavenly Father again after this life on earth.</p> <p>Emphasize the following points as you tell the story:</p> <ol style="list-style-type: none"> 1. In Jesus’ day talents were pieces of money. 2. The servant who received five talents used them wisely and soon earned five more talents. 3. The servant who received two talents used them wisely and soon earned two more talents. 4. The servant who received one talent hid it and did not use it at all. 5. The servants’ master returned and asked the servants what they had done with their talents. <p>Read aloud from Matthew 25:21 what the master said to the servant who was given five talents and earned five more.</p> <p>Explain that the master said the same thing to the servant who was given two talents and earned two more. The master was pleased with these two servants for using their talents wisely.</p> <p>Explain that the master told the third servant that because he had not used his talent, it would be taken from him and he would not have it anymore (see Matthew 25:26–29).</p>
Teacher presentation	<p>Help the children understand that we should be like the first two servants in the parable. Although we use the word <i>talents</i> to refer to things we can do rather than to money, we should still use our talents wisely.</p> <p>Explain that as spirit children of our Heavenly Father we have each received special talents or gifts to use and develop here on earth. When we use our talents, we make ourselves and others happy. Like the master in the story,</p>

Heavenly Father does not want us to hide our talents and perhaps lose them. He wants us to use our talents so they will grow. Then we can be prepared to live with Heavenly Father and Jesus Christ again.

We Develop Our Talents by Practicing

Story and discussion

Show picture 2-57, Heber J. Grant. Explain that you are going to tell a story about Heber J. Grant, who later became a prophet and President of the Church, and what he did to develop his talents:

When Heber J. Grant was a boy, he wanted to play ball. But he was not able to throw the ball very far. The other boys made fun of him when he tried to throw.

Heber decided that he would learn to play ball so well that he would be chosen to play on a championship team. Day after day he practiced throwing the ball against the side of a barn. Sometimes his arm hurt so much that he could hardly sleep at night. But he kept practicing. After a few years, Heber did play on a team that won a championship.

- What talent did Heber want to have?
- What did Heber do to develop this talent?
- What happened because Heber practiced playing ball?

Later in life Heber wanted to work in a bank as a bookkeeper. But a bookkeeper's handwriting had to be neat and easy to read. One of Heber's friends told him, "[Your] writing looks like hen tracks." Another friend said, "It looks as if lightning had struck an ink bottle."

Heber spent many hours practicing to improve his handwriting. Some years later he received an award for having the best handwriting in the state. He also taught handwriting and bookkeeping at a university.

- What talent did Heber want to have?
- What did Heber do to develop this talent?
- What happened because Heber practiced his handwriting?

When Heber was young, his mother wanted him to learn to sing. When he was ten he joined a singing class. The teacher tried to teach Heber to sing but finally gave up and told Heber he would never learn. Years later Heber talked with a friend who taught singing. Heber mentioned that he would love to be able to sing a few hymns. The friend told him it would take time and effort, but he could do it. Heber was willing to do plenty of practicing, and he did learn to sing the Church hymns. (See Bryant S. Hinckley, *Heber J. Grant: Highlights in the Life of a Great Leader* [Salt Lake City: Deseret Book Co., 1951], pp. 37–42, 45–49.)

- What talent did Heber want to have?
- What did Heber do that helped him learn to play ball, improve his handwriting, and sing?

Explain to the children that we develop our talents by practicing, as Heber did. The more we do something, the better we become at it. Heber practiced using his talents over and over, so he became better at them. Heavenly Father is pleased when we practice using the talents he has given us.

Summary

Activity	<p>Review the specific talents of each child, as discussed earlier in the lesson. Give the children their lists of talents and pencils or crayons. On the blank side of their papers, have the children draw pictures of a talent they have or would like to have.</p> <p>Let the children tell each other about their pictures and discuss how they can help the illustrated talents grow.</p>
Testimony	<p>Bear your testimony that Heavenly Father has given each of us different talents. Remind the children that Jesus Christ and Heavenly Father want us to use our talents. When we use our talents, we can make ourselves and other people happy, and we help our talents grow.</p> <p>Read aloud or have the children read the words at the top of each child's list: "Ask me about my talents." Encourage the children to show their lists to their families and tell their families what they have learned about talents.</p> <p>Invite a child to give the closing prayer. Suggest that the child thank Heavenly Father for each class member's talents and ask Heavenly Father to help the children use their talents well.</p>

Enrichment Activities

Choose from the following activities those that will work best for the children in your class. You can use them in the lesson itself or as a review or summary. For additional guidance, see "Class Time" in "Helps for the Teacher."

1. Have the children sit in a circle. Hum, sing, or play some recorded music while they pass a beanbag or other soft object around the circle. When the music stops, the child holding the beanbag stands in the center of the circle and performs a talent. Talents could include reciting a poem, singing a song, reading a scripture, hopping on one foot, or drawing a simple picture on the chalkboard. Children could pantomime talents that cannot be demonstrated in the classroom, such as performing an act of kindness or kicking a ball. Ask the children to applaud softly after each child performs.

Continue until every child has had at least one opportunity to perform.

2. Give each child crayons and a piece of paper on which you have drawn a star (a star pattern can be found at the end of the lesson). Ask the children to color their stars in unusual ways. When all the children are finished coloring, have them display their stars and sing or say the words to the first verse of "Every Star Is Different" (*Children's Songbook*, p. 142).

Ev'ry star is different,
 And so is ev'ry child.
 Some are bright and happy,
 And some are meek and mild.
 Ev'ry one is needed
 For just what he can do.
 You're the only person
 Who ever can be you.

(© 1980 by K. Newell Dayley. Used by permission.)

Help the children understand that just as their stars are all different, they are all different because they have different talents and abilities. Remind the children that talents are blessings from Heavenly Father.

3. Teach the children a simple skill that could be developed into a talent, such as leading a song or making a craft item.

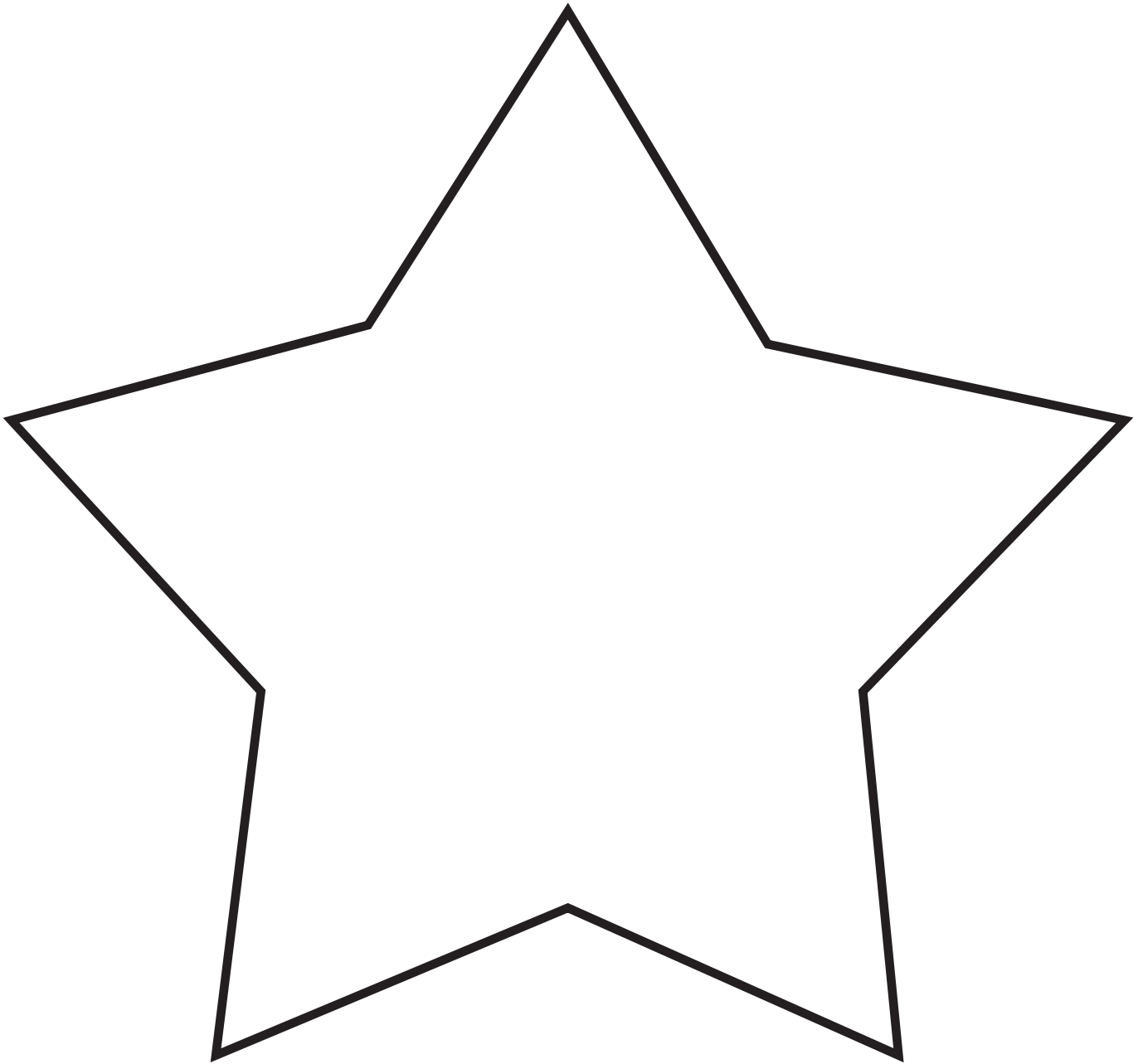

I Am Wise When I Choose the Right

Lesson
36

Purpose To help each child understand that we are wise when we obey the teachings of Jesus Christ.

Preparation

1. Prayerfully study Matthew 7:24–27.
2. Prepare two signs, using folded pieces of paper as shown:



3. Prepare to sing or say the words to “The Wise Man and the Foolish Man” (*Children’s Songbook*, p. 281) and “Choose the Right Way” (*Children’s Songbook*, p. 160). The words to “Choose the Right Way” are included at the back of the manual.
4. Write some wise actions and some foolish actions on small pieces of paper. Use the actions below and add others that are appropriate for your class. Place the pieces of paper in a small container such as a box, bowl, or bag.

Say your prayers.
Obey your parents.
Be reverent at Primary.
Be kind to others.
Share.
Tell the truth.

Quarrel.
Say a bad word.
Be selfish.
Tell lies.
Be unkind.
5. Materials needed:
 - a. A Bible.
 - b. A hat, a pair of gloves, and a pair of shoes (or three other articles of clothing the children in your class might wear).
 - c. CTR chart (see lesson 1).
6. Make the necessary preparations for any enrichment activities you want to use.

Suggested Lesson Development

Invite a child to give the opening prayer.

Follow up with the children if you encouraged them to do something during the week.

We Can Make Wise Decisions

Attention activity

Display the gloves, hat, and shoes (adapt this activity as needed if you are using other articles of clothing). Put the gloves on top of your head.

- Is this how we should wear gloves? Why?
- What should we use gloves for?

Point out that it would be foolish to put gloves on your head because then they could not protect your hands.

Invite a child to demonstrate the wise way to wear gloves.

Put the hat on one of your feet.

- Is this how we should wear a hat? Why?
- What should we use hats for?

Point out that it would be foolish to put a hat on your foot because then it could not protect your head.

Invite another child to demonstrate the wise way to wear a hat.

Put the shoes on your hands.

- Is this how we should wear shoes? Why?
- What should we use shoes for?

Point out that it would be foolish to put shoes on your hands because then they could not protect your feet.

Invite another child to demonstrate the wise way to wear shoes.

Point out that few people would wear gloves, hats, or shoes on the wrong parts of their bodies. But choices about what to wear can also be wise or foolish. Briefly discuss with the children when it would be wise or foolish to wear different articles of clothing (for example, it would be wise to wear gloves when you are going outside in cold weather, but it would be foolish to wear shoes when you are taking a bath).

Explain that we make many choices each day. Foolish choices can harm us and make us unhappy. Wise choices help keep us safe and happy.

Jesus Christ Wants Us to Be Wise and Obey His Teachings

Scripture story

Explain that Jesus Christ often used stories called parables to teach people. He told one parable about a man who made a foolish decision and a man who made a wise decision. Tell the children that you are going to read this parable from the Bible. Read aloud Matthew 7:24–27.

Discussion

- How do you think the man who built his house on the sand felt when the storm knocked his house down?
- How do you think the man who built his house on the rock felt when the storm did not hurt his house?

Explain that Jesus compared us to the men in the parable. If we follow Jesus' teachings, we are like the wise man who built his house on the rock. We will be happy. If we do not follow Jesus' teachings, we are like the foolish man who built his house on the sand. We will be unhappy.

Song

Help the class sing or say the words to “The Wise Man and the Foolish Man,” using the actions indicated below:

The wise man built his house upon the rock (*plant right fist solidly in palm of left hand*),

The wise man built his house upon the rock (*plant right fist solidly in palm of left hand*),

The wise man built his house upon the rock (*plant right fist solidly in palm of left hand*),

And the rains came tumbling down (*raise hands high in the air; then bring them down, wiggling fingers*).

The rains came down, and the floods came up (*lower hands again; then raise them with palms up*),

The rains came down, and the floods came up (*lower hands again; then raise them with palms up*),

The rains came down, and the floods came up (*lower hands again; then raise them with palms up*),

And the house on the rock stood still (*plant right fist solidly in palm of left hand*).

The foolish man built his house upon the sand (*wiggle fingers and move arms back and forth in front of body*),

The foolish man built his house upon the sand (*wiggle fingers and move arms back and forth in front of body*),

The foolish man built his house upon the sand (*wiggle fingers and move arms back and forth in front of body*),

And the rains came tumbling down (*raise hands high in the air; then bring them down, wiggling fingers*).

The rains came down, and the floods came up (*lower hands again; then raise them with palms up*),

The rains came down, and the floods came up (*lower hands again; then raise them with palms up*),

The rains came down, and the floods came up (*lower hands again; then raise them with palms up*),

And the house on the sand washed away (*wiggle fingers and move arms out away from body*).

We Are Wise When We Choose the Right

Story and discussion

Explain that everyone makes choices every day. We can make wise choices or we can make foolish ones. Tell in your own words the following story about B. H. (Harry) Roberts, who grew up to become a General Authority. Have the children decide whether Harry’s choices in the story are wise or foolish.

Harry was born in England a long time ago. His family was very poor, so Harry did not have a chance to go to school. He wanted very much to learn to read and write. He thought that if he could have a chance to learn he would not only read books but write them too.

When Harry was ten years old, he came to America and crossed the plains with his sister Polly and other pioneers.

Harry had many adventures. One day he heard that his group would be crossing a large river the next day. This sounded exciting, so Harry crept out of camp early the next morning and set out to see the river. This was against the camp rules.

- Do you think Harry’s decision to sneak out of camp was wise or foolish?

The river was farther away than Harry thought, and he was tired when he finally got there. He lay down and fell sound asleep among some willows.

When Harry woke up, all the wagons had crossed the river. He ran to the riverbank and shouted to get someone’s attention. He was told to swim across, so he took off his coat and shoes and jumped into the river. He almost made it across the river, but he became too tired, and the captain of the company had to bring him the rest of the way on his horse. Harry was happy to be safe, but there was no way to get his coat and shoes back. Every night he wished he still had his coat, and every day he wished he still had his shoes.

Harry had to walk nine hundred miles barefoot. This made his feet very sore. Prickly cactus grew near the trail, and Harry was so hungry that he often gathered it for food. The sharp spines stuck in his sore feet. Polly pulled the spines out while they both cried. Harry cried because his feet hurt, and Polly cried because she felt sorry for Harry.

- Why was Harry’s choice to sneak out of camp a foolish choice?
- How did Harry feel about his choice afterward?

After Harry arrived in Salt Lake City, he finally had an opportunity to go to school. When he was eleven years old, a teacher took him into her school and taught him the alphabet. The only book Harry had was the Bible, and he read it over and over. He studied hard in school and became a very good student.

- What choices did Harry make? (He chose to learn to read, and he chose to study the scriptures.)
- Were these choices wise or foolish?

When Harry grew up, he became a wise and important man in the Church. He loved to read and enjoyed reading the scriptures. He also wrote many books about the Church. Many people have read his books and learned more about the Church. (See *Church News*, 19 July 1980, pp. 8–9; and Truman G. Madsen, *Defender of the Faith: The B. H. Roberts Story* [Salt Lake City: Bookcraft, 1980], pp. 19–21, 37–40, 56–57.)

CTR chart

Display the CTR chart and have the children repeat the words with you: “I will choose the right.” Explain to the children that when we choose the right we are making wise decisions.

Summary

Activity

Display the signs labeled “wise” and “foolish” on the floor or table. Have the children say with you the word on each sign. Point out that the “wise” sign has a happy face on it because being wise makes us happy. Point out that the “foolish” sign has a sad face on it because being foolish makes us unhappy.

Show the container with the small pieces of paper and invite the children to take turns choosing a paper from the container. As each child chooses a paper, read or have the child read the action written on it. Have the child decide whether the action is wise or foolish and place the paper by the appropriate sign.

Encourage the children to do the actions they identified as wise choices.

Review discussion

- What kind of choices make us happy?
- In order to be wise and happy, whose teachings should we follow?
- Why is it foolish to disobey Jesus Christ and do wrong?

Testimony

Testify to the children that we will be happy when we make wise choices. Express your appreciation for Jesus Christ and the things he taught that help us be happy.

Encourage the children to make a special effort this week to think about their decisions and try to make wise choices.

Song

Sing or say the words to “Choose the Right Way” with the children.

Invite a child to give the closing prayer. Ask the child to pray that each class member will be wise and choose the right.

Enrichment Activities

Choose from the following activities those that will work best for the children in your class. You can use them in the lesson itself or as a review or summary. For additional guidance, see “Class Time” in “Helps for the Teacher.”

1. Show picture 2-7, The Wise Men, and have the children tell you about the picture. Remind the children that the Wise Men came looking for Jesus after he was born (see Matthew 2:1–12). Explain that these men were wise not only because they had great knowledge but also because they sought and worshiped Jesus Christ. They made wise choices to follow Jesus.

You may want to have the children role-play the story of the Wise Men seeking Jesus.

2. Ask each child to tell you about a wise choice he or she has made recently (give suggestions if necessary). Write each child’s response on a separate piece of paper and have the children draw pictures of themselves on their papers. Remind the children to put smiles on the faces of their drawings because making wise choices helps us be happy.
3. Demonstrate the following object lesson (practice this demonstration at home before trying it in class).

Materials needed:

- a. Eight or ten children’s play blocks to build two simple identical houses, as shown:

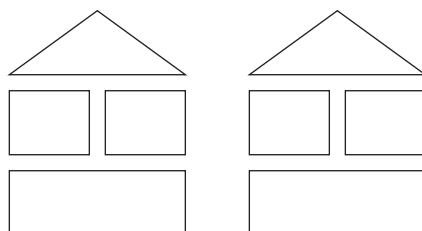

- b. Two deep pans the same size.
- c. A large flat rock to put in one of the pans.
- d. A mound of sand to put in the other pan.
- e. Water in a watering can or pitcher.

Pour the sand into a mound in one pan, and flatten the mound. Put the flat rock in the other pan.

Show the blocks and explain that you will use them to build two houses. One house will be built on the sand and the other on the rock.

You may wish to ask the children to help build the house on the rock. The house should be similar to the house you build on the sand.

After the houses are built, have the children imagine that a storm comes and beats upon the houses. It rains hard and the winds blow.

- What do you think a storm would do to these two houses?

After the children have given their ideas, do not comment. Carefully sprinkle or pour water on the house built on sand until the sand slides away and the house falls down. Put the same amount of water on the house built on the rock, and let the children observe that the house does not fall.

Help the children determine that building a house on sand was foolish, while building a house on the rock was wise.

Read aloud the first part of Helaman 5:12 (through *foundation*). Point out that this scripture compares Jesus Christ to a rock. Remind the children that following the teachings of Jesus is like building a house on a rock. It is wise.

I Can Keep the Sabbath Day Holy

Lesson
37

Purpose To strengthen each child's desire to keep the Sabbath day holy.

Preparation

1. Prayerfully study Exodus 20:8–11 and Matthew 12:10–13. See also *Gospel Principles* (31110), chapter 24.
 2. Make a tracing or copy of the calendar found at the end of the lesson. Color the Sabbath days red. You may want to number the days according to the current month.
 3. Prepare the following wordstrip:

"Remember the sabbath day, to keep it holy."
 4. Make a tracing or copy of both Sabbath day activity sheets (found at the end of the lesson) for each child. For younger children, cut the pages apart on the dotted lines. For older children, bring a few pairs of scissors so the children can cut the pages apart themselves.
 5. Prepare to sing or say the words to "Saturday" (*Children's Songbook*, p. 196).
 6. Materials needed:
 - a. A Bible.
 - b. Crayons.
 - c. A stapler or other means of fastening the activity sheets together.
 - d. Picture 2-58, Jesus Healing a Man with a Withered Hand.
 7. Make the necessary preparations for any enrichment activities you want to use.
-

Suggested Lesson Development

Invite a child to give the opening prayer.

Follow up with the children if you encouraged them to do something during the week.

The Sabbath Is a Special Day

Attention activity

Show the children the calendar and explain that it shows all the days of the month. Briefly discuss what calendars can be used for.

- What is unusual about this calendar?
- What day is colored red?
- Why is this a special day? (It is the Sabbath day.)

Teacher presentation

Tell the children that since the beginning of the world, one day each week has been set apart for learning and thinking about Heavenly Father and Jesus Christ and for doing good to others. This day is called the Sabbath.

- What day of the week is the Sabbath day?

Scripture and wordstrip	<p>Read Exodus 20:8 aloud and display the wordstrip. Help the children repeat this scripture in unison. Tell them that this is a commandment.</p> <p>Explain that keeping the Sabbath day holy means we do things that remind us of Heavenly Father and Jesus Christ, such as going to church, reading the scriptures, and doing other reverent things.</p>
	<p>We Can Keep the Sabbath Day Holy</p>
Discussion	<p>Discuss with the children the kinds of activities that are appropriate for the Sabbath. Ask them what things they have done today to keep the Sabbath day holy. Help them understand that going to church, praying, singing, giving talks in church meetings, learning about the teachings of Jesus, and partaking of the sacrament are some of the things we can do to keep the Sabbath day holy.</p> <p>Explain that we should not work on Sunday, if possible, and we should not do things that keep us from thinking about Heavenly Father and Jesus Christ.</p>
Activity	<p>Describe some activities the children might participate in. Ask the children to smile if the activity is something we should do on the Sabbath and to frown if the activity is not something we should do on the Sabbath. Use the examples below or others appropriate for the children in your class.</p> <ul style="list-style-type: none"> • Going to church. • Cleaning the house. • Visiting relatives. • Going shopping. • Going to a movie. • Reading the scriptures or other good books. • Praying. • Watching or participating in a game of sports. • Writing letters. • Going for a walk. • Playing scripture games. • Visiting a sick person. <p>Jesus Christ Kept the Sabbath Day Holy</p> <p>Tell the children that it is not always easy to know whether an activity is something we should do on the Sabbath. The best way to know what to do is to follow Jesus Christ's example.</p>
Scripture story	<p>Show picture 2-58, Jesus Healing a Man with a Withered Hand, and tell the story found in Matthew 12:10–13.</p> <p>Explain that the Pharisees were people who didn't like Jesus Christ and what he did. They tried to trap him into saying things that were wrong or against the law. They asked him if it was wrong to heal someone on the Sabbath day. They wanted him to say it was.</p>

Tell the children that Jesus pointed out that if the Pharisees had a sheep that fell in a hole on the Sabbath, they would help it out. Since people are more important than sheep, helping people is a good thing to do on the Sabbath. Read aloud the second part of Matthew 12:12 (from *Wherefore*).

Remind the children that if an activity is something that Jesus would do, such as helping or being kind to others, it is a good thing to do on the Sabbath day.

Keeping the Sabbath Day Holy Takes Preparation

Discussion

Point out that to keep the Sabbath day holy, we need to do certain things before the Sabbath in order to be prepared.

- What things do you and your family need to do to be ready for the Sabbath? (Answers may include washing and ironing clothes to wear to church, cleaning the house, preparing meals to eat on the Sabbath, and finding scriptures and other items needed for church.)
- When should you do these things?

Song

Sing or say the words to “Saturday.” Help the children pantomime the actions mentioned in the song. (If the Sabbath is on a day other than Sunday in your area, change the words *Saturday*, *Sunday*, and *Monday* to the appropriate days.)

Saturday is a special day.

It’s the day we get ready for Sunday:

We clean the house, and we shop at the store,

So we won’t have to work until Monday.

We brush our clothes, and we shine our shoes,

And we call it our get-the-work-done day.

Then we trim our nails, and we shampoo our hair,

So we can be ready for Sunday!

Encourage the children to prepare next week so they will be ready to keep the Sabbath day holy.

Summary

Activity

Give each child a copy of the Sabbath day activity sheets. Help the children read with you the title of the sheets: “My Sabbath Day Book.” Help the children cut the pages apart if you have not already cut them.

Read the following sentences describing appropriate Sabbath activities, and help the children choose the picture that shows each activity.

- On the Sabbath we go to church to honor Heavenly Father and Jesus Christ and learn about them.
- The Sabbath day is a good day to study the gospel with our families. We can read the scriptures and other good books.
- The Sabbath day is a day of prayer. We pray at church, with our families, and by ourselves.
- On the Sabbath day we can sing hymns and listen to good music.
- On the Sabbath day we can write in our journals and write letters to or draw pictures for our relatives, friends, and the missionaries.
- The Sabbath day is a good day to visit family members or people who are sick or lonely.

Give the children crayons and let them color the pictures. Ask them to draw on the blank page a picture of something they are going to do to keep the Sabbath day holy.

Help the children staple or fasten the pages of their books together.

Testimony

Bear your testimony about the importance of keeping the Sabbath day holy. You may want to mention one or two things that you like to do on the Sabbath and tell how you feel when you do those things. Emphasize that the Sabbath should be a happy day as we think and learn about Heavenly Father and Jesus Christ.

Encourage the children to show their books to their families and share what they have learned today. Suggest that the children keep the books in a place where they can remind the children to keep the Sabbath day holy.

Invite a child to give the closing prayer. Suggest that the child ask Heavenly Father to help the class members keep the Sabbath day holy.

Enrichment Activities

Choose from the following activities those that will work best for the children in your class. You can use them in the lesson itself or as a review or summary. For additional guidance, see “Class Time” in “Helps for the Teacher.”

1. Sing or say the words to the first verse of “When I Go to Church” (*Children’s Songbook*, p. 157). Have the children stand and do the actions indicated below as they sing:

I always have a happy feeling
When I go to church (*place hands over heart, and smile*).
The organ plays so soft and sweet (*cup hands behind ears*);
I tiptoe softly to my seat (*tiptoe in place and put finger to lips*).
My teachers and my friends I greet (*quietly shake hands with person next to you*)
When I go to church (*sit in chair*).

2. Draw a pair of eyes, a pair of ears, a mouth, and two hands on the chalkboard. Ask the children to tell you what each of these parts of our bodies can do to keep the Sabbath day holy.

Examples:

Eyes—read the scriptures, watch the speakers and teachers at church.

Ears—listen to uplifting music or stories, listen to the Primary lesson.

Mouth—sing hymns or Primary songs, say kind things to family members and friends.

Hands—draw a picture for family members who live far away, write in a journal.

3. Help the children memorize Exodus 20:8: “Remember the sabbath day, to keep it holy.”

4. Sing or say the words to “Remember the Sabbath Day” (*Children’s Songbook*, p. 155).

Remember the Sabbath day,

To always keep it holy.

The Lord blessed and hallowed it,

That we might worship him.

The Sabbath Day Is a Holy Day

Sunday

Monday

Tuesday

Wednesday

Thursday

Friday

Saturday

My Sabbath Day Book

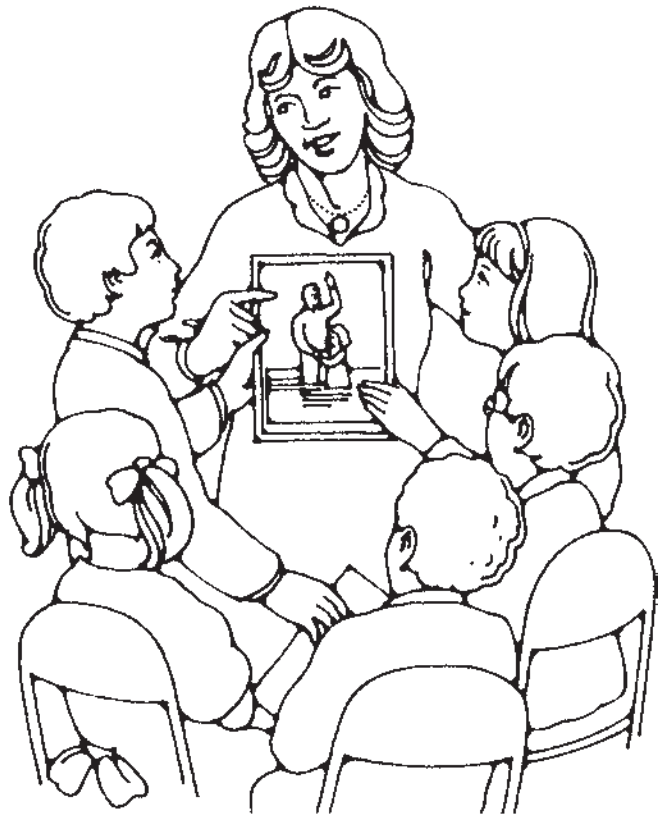

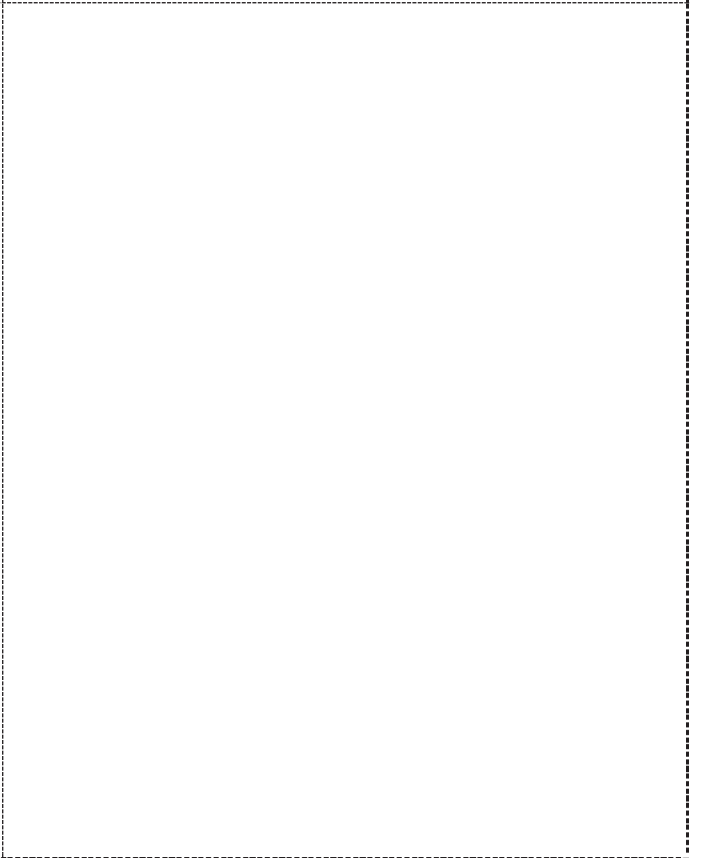
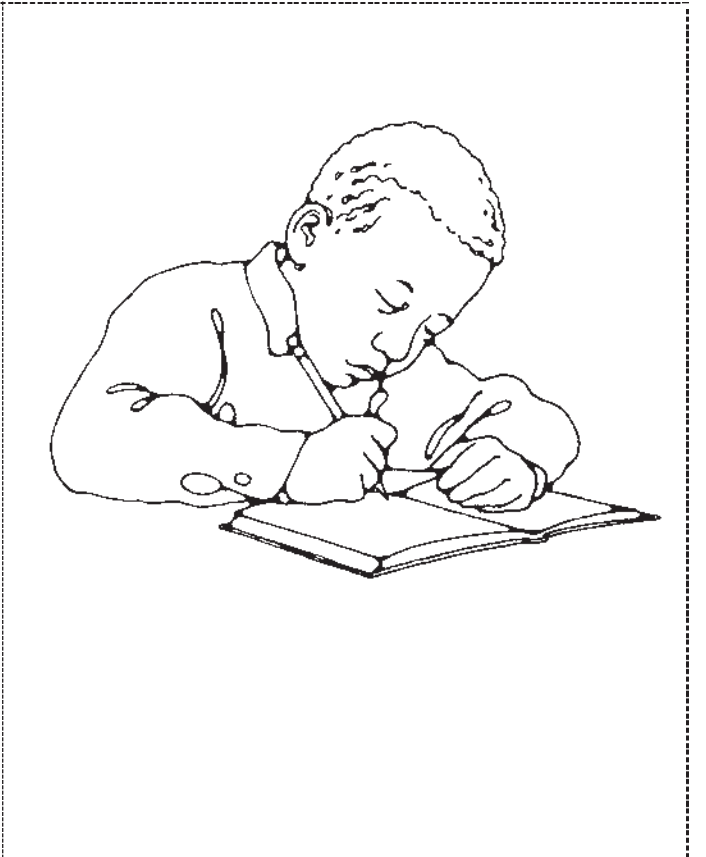

Lesson
38

I Will Remember Jesus Christ during the Sacrament

Purpose

To inspire each child to remember Jesus Christ during the sacrament.

Preparation

1. Prayerfully study Luke 22:7–20 and Doctrine and Covenants 20:75–79. See also *Gospel Principles* (31110), chapter 23.
 2. Prepare to help the children sing one or two songs about Jesus Christ, such as “I Think When I Read That Sweet Story” (*Children’s Songbook*, p. 56) and “Jesus Said Love Everyone” (*Children’s Songbook*, p. 61). The words to these songs and others about Jesus are included at the back of the manual.
 3. Prepare to tell one of your favorite stories about Jesus Christ, using a picture if one is available.
 4. Materials needed:
 - a. A Bible and a Doctrine and Covenants.
 - b. Sacrament trays for the bread and the water.
 - c. Picture 2-29, Passing the Sacrament (62021); picture 2-54, The Last Supper (Gospel Art Picture Kit 225; 62174); picture 2-59, The *Christus*.
 5. Make the necessary preparations for any enrichment activities you want to use.
-

Suggested**Lesson****Development**

Invite a child to give the opening prayer.

Follow up with the children if you encouraged them to do something during the week.

Jesus Christ Gave Us the Sacrament

Attention activity

Show the children the sacrament trays.

- What are these used for?

Let the children tell what they know about the sacrament trays and about the sacrament. Tell them that today’s lesson is about the sacrament.

Scripture story and discussion

Display picture 2-54, The Last Supper. If the children recognize it, ask them to tell about what is happening in the picture. If they do not recognize the picture, tell them that this is a picture of Jesus Christ and his Apostles. Ask the children to point out Jesus.

Tell the story of the Last Supper, as found in Luke 22:7–20.

Explain that Jesus Christ and his Apostles were celebrating a special Jewish holy day called the feast of the Passover. Jesus knew that this feast would be the last meal he ate with the Apostles. Tell the children that we often refer to this meal as the Last Supper.

Explain that Jesus loved his Apostles. He chose these men to lead the members of his church after he was gone. He had taught them many things and wanted them to remember him and his teachings.

- Why was it important for the Apostles to remember Jesus?
- What did Jesus give the Apostles to help them remember him?

Read aloud Luke 22:19. Point out that this scripture tells us that the Savior broke some bread into small pieces, blessed it, and gave it to the Apostles to eat. He told them that the bread was to remind them of his body and that they were to remember him when they ate it.

Tell the children that after each Apostle had eaten a piece of bread, Jesus blessed a drink made from grapes and gave it to the Apostles. He told them that the drink was to remind them of his blood. When they drank it, they should remember that Jesus died so they could live with Heavenly Father again after they died.

Explain that Jesus knew that if the Apostles would remember him and his teachings, it would help them choose the right.

- What do we call the bread and drink that Jesus gave to his Apostles at the Last Supper? (The sacrament.)
- Why did Jesus give the sacrament to the Apostles?

We Take the Sacrament to Remember Jesus Christ

Discussion

Show picture 2-29, Passing the Sacrament, and remind the children that we take the sacrament just as Jesus' Apostles did. (You may want to explain that we use water instead of the drink Jesus gave his Apostles.)

- When do we take the sacrament?

Point out that the meeting when we take the sacrament is called sacrament meeting because the sacrament is the most important part of that meeting.

- Why do we take the sacrament?
- How can the sacrament help us remember to choose the right?

Scripture

Remind the children that before the sacrament is passed, special prayers are said. The prayers tell Heavenly Father some things we promise to do. Ask the children to listen carefully while you read the prayer that is said over the bread, so they can discover two promises we make to Heavenly Father when we take the sacrament.

Read aloud Doctrine and Covenants 20:77, emphasizing the phrases "that they may eat in remembrance of the body of thy Son, and witness unto thee" and "always remember him and keep his commandments which he has given them."

Tell the children that "witness unto thee" means we are making a promise to Heavenly Father.

- What two things do we promise to do?

Explain that each time we take the sacrament we are promising to remember Jesus and keep his commandments.

We Can Think of Jesus Christ's Love for Us during the Sacrament

- Teacher presentation Show picture 2-59, *The Christus*. Explain that the picture shows a statue of Jesus Christ. In the background is a painting of some of the planets and stars. Let the children talk about the picture for a few moments.
- Explain that during the sacrament we should think about the Savior and his love for us. We can remember pictures of Jesus we have seen, such as the one just shown, and we can also think about stories of Jesus.
- Story Tell one of your favorite stories about Jesus, using a picture if one is available. Explain how the story shows Jesus' love for people.
- Child participation Have each child tell a story about Jesus Christ or tell something he or she remembers about Jesus. As the children talk, emphasize how Jesus' love for us is shown in the stories and the things the children remember about Jesus.
- Compliment the children for remembering stories about Jesus. Tell them that there are many stories we can think about during the sacrament. When we think during the sacrament about Jesus and how much he loves us, we will be remembering him.
- Song Explain that we also know many songs about Jesus Christ. Although we don't sing aloud while the sacrament is being passed, we can think of the words to the songs to help us remember Jesus.
- Sing with the children one or two familiar songs about Jesus, such as "I Think When I Read That Sweet Story" and "Jesus Said Love Everyone."

Reverence during the Sacrament Will Help Us Remember Jesus Christ

- Discussion Explain that when we are reverent during the sacrament, it is easier to think about Jesus.
- How can we be reverent during the sacrament?
- Make sure the following ideas are mentioned:
- Listen to the sacrament prayers and say "amen" at the end.
 - Don't bother our parents or other people. They need to think about Jesus too.
 - Put away pencils, books, or other items before the sacrament.
 - Be quiet and stay in our seats.
 - Think about Jesus by remembering stories and songs about him, his love for us, and the things he taught.
 - Take the piece of bread and cup of water nearest to us.
 - Put the sacrament cups back without playing with them.
- Activity Ask the children to pretend they are sitting in sacrament meeting and it is time for the sacrament. Ask them to show the answers to the following questions without talking:
- What can you do with your mouth to show you are thinking about Jesus?
 - What can you do with your head to show you are reverent?

- What can you do with your arms and hands to show you are thinking about Jesus?
- What can you do with your feet to show you are reverent?

Have the children sit quietly for a minute or so and think about Jesus Christ, just as they should while the sacrament is being passed. Then have them share what they were thinking about Jesus.

Summary

Activity

Ask the children to listen carefully as you read some statements about things they could do or think about during the sacrament. Tell the children that if the statement describes something they should do or think about during the sacrament, they should stand up. If the statement describes something they should not do or think about during the sacrament, they should sit down.

Use the following statements or create some of your own:

- Remember that Heavenly Father and Jesus Christ love us.
- Think about going out to play.
- Think about Jesus making sick people well.
- Whisper and talk to your neighbor.
- Wiggle in your seat.
- Think about the sacrament song or another song about Jesus.
- Say a prayer to Heavenly Father.
- Draw pictures or play with a toy.
- Remember stories about Jesus.

Testimony

Bear your testimony of Jesus Christ. Tell the children how you feel about being able to take the sacrament.

Encourage the children to remember Jesus Christ and be reverent during the sacrament.

Invite a child to give the closing prayer.

Enrichment Activities

Choose from the following activities those that will work best for the children in your class. You can use them in the lesson itself or as a review or summary. For additional guidance, see “Class Time” in “Helps for the Teacher.”

1. Sing or say the words to “To Think about Jesus” (*Children’s Songbook*, p. 71).

It shouldn’t be hard to sit very still,
 And think about Jesus, his cross on the hill,
 And all that he suffered and did for me;
 It shouldn’t be hard to sit quietly.
 It shouldn’t be hard, even though I am small,
 To think about Jesus, not hard at all.

I think of the miles he walked in the dust,
And children he helped to love and to trust;
It shouldn't be hard to sit tall in my seat,
To listen politely, to quiet my feet.
It shouldn't be hard, even though I am small,
To think about Jesus, not hard at all.

2. With the approval of your Primary president, ask the bishop (or branch president) to arrange for a priest or deacon to visit the class and briefly explain his duties regarding the sacrament.
3. Make a copy of the picture of children sitting reverently (found at the end of the lesson), color it, and cut it into five puzzle pieces. Print one of the following questions on the back of each piece:
 - What is the most important thing we do at sacrament meeting?
 - What does the priest do when it is time for the sacrament?
 - What do the deacons do with the sacrament?
 - How should we sit during the sacrament?
 - What should we think about during the sacrament?

Spread the puzzle pieces on the floor or table. Have a child select a puzzle piece. Ask the children the question on the back of the piece and help them answer it. When all the questions have been answered, help the children put the puzzle together.

4. Help the children say the following verse:

The Sacrament

I'll fold my arms, I'll bow my head,
And quiet, quiet be;
As the sacrament is blessed,
I will remember Thee.
(DeVota M. Peterson)

Repeat the verse a few times to help the children memorize it.

You may want to ask the following questions before repeating the verse:

- What do we fold?
- What do we bow?
- During the sacrament are we supposed to be quiet or noisy?
- Who should we think about during the sacrament?

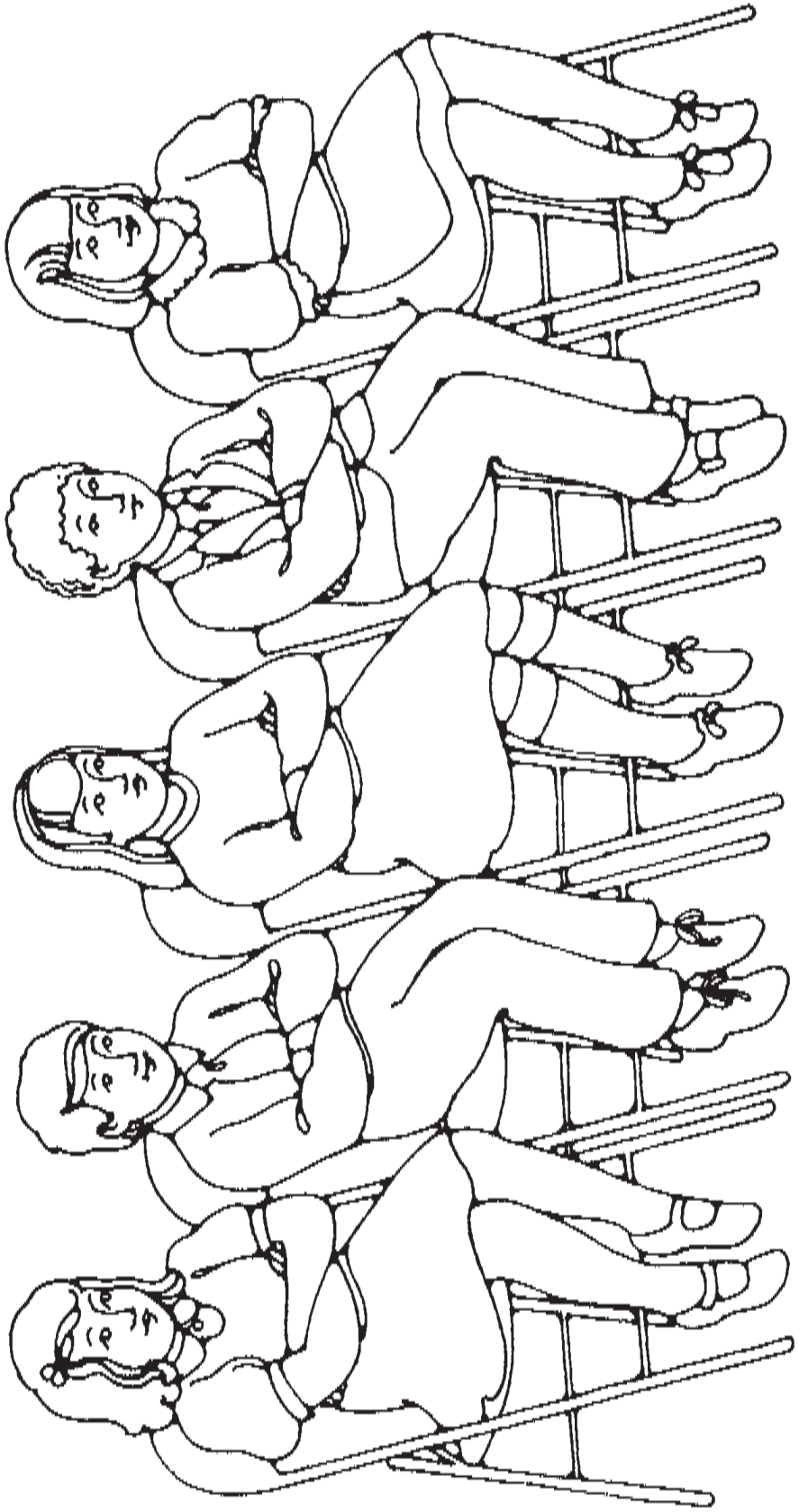

Lesson
39

I Can Follow Jesus Christ by Serving Others

Purpose	To strengthen each child’s desire to follow Jesus Christ by serving others.
----------------	---

Preparation	<ol style="list-style-type: none">1. Prayerfully study John 13:1–17 and Articles of Faith 1:13. See also <i>Gospel Principles</i> (31110), chapter 28.2. Prepare to sing or say the words to all three verses of “‘Give,’ Said the Little Stream” (<i>Children’s Songbook</i>, p. 236) and the fourth verse of “I Feel My Savior’s Love” (<i>Children’s Songbook</i>, p. 74). The words to these songs are included at the back of the manual.3. Prepare to tell about a time when you were blessed because you served someone.4. Materials needed:<ol style="list-style-type: none">a. A Bible.b. Paper and pencils or crayons for each child.c. Picture 2-60, Jesus Washing the Feet of the Apostles (Gospel Art Picture Kit 226; 62550).5. Make the necessary preparations for any enrichment activities you want to use.
--------------------	--

Suggested Lesson Development	<p>Invite a child to give the opening prayer.</p> <p>Follow up with the children if you encouraged them to do something during the week.</p> <p>Jesus Christ Wants Us to Serve Others</p>
Attention activity	<p>As you begin the lesson, “accidentally” spill some crayons, papers, or other materials onto the floor of your classroom. Wait a moment before picking the items up to give the children a chance to help you. (If no children volunteer, ask the children to help.)</p> <p>Thank the children for helping you and compliment them for taking an opportunity to serve. Explain that when we help others without asking for something in return, it is called service. Have the children repeat the word <i>service</i> with you.</p>
Song	<p>Sing or say the words to all three verses of “‘Give,’ Said the Little Stream” with the children.</p> <p>Point out that the last verse says we should give as Jesus gives. Tell the children that when Jesus was on the earth, he served other people often.</p>
Scripture story	Show picture 2-60, Jesus Washing the Feet of the Apostles, and tell the story found in John 13:1–17. Remind the children that Jesus had called the Apostles shown in the picture to help lead his church.

Remind the children of what they learned in the previous lesson about the Last Supper. Explain that after Christ taught his Apostles about the sacrament, he taught them how important it is to serve others.

Explain that it was not unusual for people to have their feet washed, because most people wore sandals and their feet became very dusty and dirty. But usually a servant did this job. Explain that Peter did not want Jesus to wash his feet because he thought it was not right for Jesus to act as a servant.

Tell the children that Jesus explained to the Apostles that even though he was the Savior, he still served them. He wanted them to understand that they should serve each other. Read aloud John 13:15 and explain that Jesus wants us to follow his example and serve others.

Discussion

- Why did Jesus wash the Apostles' feet?
- What did Jesus want the Apostles to do?
- What does Jesus want us to do?

Explain that Jesus Christ wants us to serve whenever we can, even if we are not asked to help or are not rewarded for our help. Point out that when we serve other people, we are following Jesus.

We Can Serve Others in Many Ways

Story

Ask the children to listen as you tell in your own words the following story of a young boy who thought of a way to serve his family:

"It was so dark that the sleepy seven-year-old boy could hardly find his way down the path to the barn. He had planned for days how he could get out of bed, dress, creep quietly down the stairs, take the milking bucket from the pantry shelf, and leave the house without waking anyone.

". . . [Joseph] had seen his sister, Mary, milk the cow many times. He found it wasn't as easy as he thought it would be. . . . Before long his fingers and wrists ached. He had to stop often to rest them. . . .

"The boy was so intent on milking that he did not realize how long it had taken, and was surprised to find that daylight had come . . . when he finally left the barn and started for the house. As he entered the kitchen, Mother looked up from the stove where she was preparing breakfast, and asked, 'Why, Joseph, what have you been doing so early in the morning?'

"He held up the filled milk bucket in answer, and felt a warm rush of joy at his mother's smile of approval. 'Well,' she said, 'since it seems you are big enough, milking each morning will be your job.' She paused and then questioned, 'But why is it you were so anxious to milk that cow?'

"Joseph lifted an earnest face to his mother as he answered, 'I just want to help while Father is on his mission. And you see, [Mary] has so many other things to do, I thought if I could take care of the morning milking, she wouldn't have to worry about that!'

". . . His mother put her arms around him and held him close as she said, 'How pleased your father will be when I write and tell him that he has a fine young man to take care of milking the cow while he is away!'" (Lucile C. Reading, "The Morning Chore," *Children's Friend*, Apr. 1970, p. 23).

Tell the children that this young boy's name was Joseph Fielding Smith, and he became the tenth President of the Church when he grew up.

- How did Joseph Fielding Smith serve?
- Whom did he serve?

Article of faith

Tell the children that the thirteenth article of faith says that we believe in serving others. Have the children stand, and help them say, "We believe . . . in doing good to all men." (You may need to explain that *all men* means all people.)

Activity

Ask every child who wants to be a disciple (follower) of Jesus Christ to stand up and remain standing. Remind the children that Jesus wants all his disciples to serve others.

- How can we serve others?

Let each child sit down as he or she names a way to serve others.

If a child has difficulty thinking of a way to serve, you may want to suggest one of the following ideas or another idea appropriate for the children in your class:

- Tell or read a story to someone younger.
- Draw a picture for your parents or grandparents.
- Put away the toys your brother left out.
- Set the table for dinner without being asked.

We Are Happy When We Serve

Discussion

- Who is happy when we serve? (Answers may include the people we are serving, ourselves, and Heavenly Father and Jesus Christ.)

Emphasize that when we serve others, not only are the people we help happy, but we are happy too.

- Why does it make you happy to serve others?

Song

Sing or say the words to the fourth verse of "I Feel My Savior's Love" with the children. (If the children do not know the fourth verse, you may want to sing or say the words to the verse yourself and then have the children join in on the chorus.)

Summary

Art activity

Help the children think of simple acts of service they could complete today, whether at church or at home. Give the children paper and crayons or pencils and have each child draw a picture of an act of service he or she will do today. Have the children show and explain their pictures to each other.

Testimony

Tell the children about a time when you were blessed by serving someone else. Testify that true happiness comes from serving others.

Encourage the children to watch for ways they can serve others this week. You may want to ask the children to report in class next time on their experiences with service.

Invite a child to give the closing prayer.

Enrichment Activities

Choose from the following activities those that will work best for the children in your class. You can use them in the lesson itself or as a review or summary. For additional guidance, see “Class Time” in “Helps for the Teacher.”

1. Arrange in advance for an act of service the children could complete together during class (make sure this service activity is appropriate for the Sabbath).

Examples:

- Arrange with the nursery teacher to have your class sing a favorite Primary song to the nursery children.
- Bring materials for the children to make thank-you cards for the Primary chorister and pianist.
- Help the children do what is necessary to prepare the classroom for the next class or for the coming week, such as erasing the chalkboard and putting away chairs.

After the children complete the act of service, discuss with them how they felt about serving. Remind them that serving can make us happy.

2. Make three small paper hearts for each child. Tell the children that you want to start a “Service in Secret” club. Encourage the children to take these hearts home and do secret acts of service for their family members, leaving a heart in each place they did an act of service. For example, they could make a brother or sister’s bed and leave a heart on the pillow. Ask the children to report back next week on the feelings they had when they served others in secret.
3. Sing or say the words to the second verse of “I’m Trying to Be like Jesus” (*Children’s Songbook*, p. 78). The words to this song are included at the back of the manual.
4. Have the children sit in a small circle on the floor. Gently toss a beanbag or other soft object to a child and ask him or her to name a way to serve someone. When the child has answered, he or she may toss the beanbag to another child in the circle. Continue until everyone has had at least one turn to name an act of service.
5. If it is available in your area, show “The Gift” (16 min.) from the videocassette *The Worth of Souls* (53147) in place of telling the story about Joseph Fielding Smith.
6. Let the children discuss or act out what they would do in each of the following situations if they were trying to serve others (adapt the situations as necessary to make them appropriate for the children in your class):
 - You are on your way to a soccer game. You are in a hurry, but as you walk down the street to the playing field you see an elderly woman drop a bag of groceries.
 - You have been at a friend’s house playing. You are very tired. As you walk into the yard you see your father working in the garden.
 - As you come into the kitchen to get a drink, you see your brother washing the dinner dishes.

- You are walking home with some friends. You see that a dog has knocked over a trash can in a neighbor's yard and has scattered the trash around. The neighbor is away and won't be back for a few days.
- You see a new girl in school and introduce yourself. The new girl asks you where you eat lunch. You had planned to eat lunch with your friends.
- Your family is getting ready to go to church. Your father has already left because he had a meeting to attend. You have several little brothers and sisters who need help getting ready.

I Can Forgive Others

Lesson
40

Purpose To help each child understand that happiness comes when we forgive others, as Jesus Christ did.

- Preparation**
1. Prayerfully study Luke 23:13–34 and John 18:12–14, 19–24; 19:1–5.
 2. Prepare to sing or say the words to the first verse of “Help Me, Dear Father” (*Children’s Songbook*, p. 99).
 3. Make the following wordstrip:

“Father, forgive them; for they know not what they do.”
 4. Prepare to tell about a time when you forgave and how you felt about forgiving.
 5. Materials needed:
 - a. A Bible.
 - b. CTR chart (see lesson 1).
 - c. Chalk, chalkboard, and eraser.
 - d. Picture 2-56, The Trial of Jesus; picture 2-61, The Crucifixion (Gospel Art Picture Kit 230; 62505).
 6. Make the necessary preparations for any enrichment activities you want to use.
-

**Suggested
Lesson
Development**

Invite a child to give the opening prayer.

Follow up with the children if you encouraged them to do something during the week. You may want to ask the children to report on their experiences with service.

We Can Forgive Others

Attention activity

Ask the children to listen carefully as you describe the following situation (adjust the situation as necessary to make it appropriate for the children in your class):

You are walking with a large load of books and papers (or other items) in your arms. Suddenly someone bumps into you. You fall down and drop the things you have been carrying. Your books and papers scatter all over the ground.

- Has something like this ever happened to you?
- How did you feel?

Tell the children that you are going to describe two different endings to this situation. Ask them to decide which is the better ending.

Ending 1

You are upset about falling and dropping all your things. When the person who ran into you apologizes and offers to help you pick up your books and papers, you say, “No!” in an angry voice and push him away. You hope that tomorrow you see him carrying a lot of things so you can knock him down.

Ending 2

You are upset about falling and dropping all your things. When the person who ran into you apologizes and offers to help you pick up your things, you say, “Thank you.” The two of you quickly pick up the books and papers. You tell the person that you know he didn’t mean to knock you down, and both of you walk away happy.

- Which is the better ending to the story?
- Why is the second ending better than the first?
- What should we do when someone does something that we don’t like or that makes us feel hurt or angry? (We should forgive them.)

Teacher presentation

Explain that to forgive someone means to feel love and kindness for that person even though they have done something that hurt us or made us angry. Sometimes it means we have to change our angry feelings toward that person to kind feelings. When we forgive others, we do not want to hurt them or get back at them. We are kind to them, even if they are not kind to us.

Jesus Christ Forgave Others

Scripture story

Show the Bible and tell the children that you are going to tell a story from the Bible about how Jesus Christ forgave those who hurt him. Tell the story of Christ’s trial and crucifixion, as found in Luke 23:13–34 and John 18:12–14, 19–24; 19:1–5.

Explain that after Jesus and his Apostles had eaten their last supper together, Jesus went to the Garden of Gethsemane to pray to Heavenly Father. After Jesus finished praying, some soldiers came, tied him with cords, and took him to the palace of the chief priest, where he was put on trial.

Show picture 2-56, The Trial of Jesus.

Point out that during the trial, the soldiers did many unkind things to Jesus. They hit him, whipped him, spit on him, put a crown of thorns on his head, and called him names. But Jesus did not become angry.

Show picture 2-61, The Crucifixion.

Tell the children that after the trial, the soldiers led Jesus to a place called Calvary and nailed him to a cross. Explain that Jesus wasn’t angry with the soldiers for what they had done to him. Instead he asked Heavenly Father to forgive the soldiers.

Scripture and wordstrip

Have the children listen to what Jesus said just before he died. Read aloud the first sentence of Luke 23:34.

Display the wordstrip and leave it up for the rest of the class period. Help the children repeat Jesus’ statement with you.

Point out that even though the soldiers were unkind to Jesus, he forgave them and asked Heavenly Father to forgive them.

Happiness Comes When We Forgive Others

Teacher presentation	Remind the children that when we are followers of Jesus Christ we try to do what he would do. Jesus always forgave those who were unkind to him. We should also forgive those who are unkind to us.
Song	<p>Sing or say the words to the first verse of “Help Me, Dear Father.” Ask the children to listen carefully to the words. Point out that the words are written like a prayer to help us feel how important it is to forgive others.</p> <p>Help me, dear Father, to freely forgive All who may seem unkind to me. Help me each day, Father, I pray; Help me live nearer, nearer to thee.</p> <p>Have the children stand and sing or say the words of the song with you. Encourage the children to think about the meaning of the words as they sing them.</p>
Story and discussion	<p>Tell the following story about a child who knew how to forgive:</p> <p>Kent’s mother had asked him to clean up the yard. He was raking up all the leaves and small branches that had fallen from the trees and plants in the yard. Kent worked hard, and finally he had gathered all the leaves and branches into one big pile. Just then Jed came down the street, ran into the pile, and kicked leaves and branches in every direction. All of Kent’s work was undone in a few seconds.</p> <ul style="list-style-type: none"> • How do you think Kent felt when Jed did this? <p>Kent’s brother saw what Jed did. He thought that Kent should chase Jed and beat him up for scattering the pile of leaves and branches.</p> <ul style="list-style-type: none"> • What could Kent do? <p>Help the children think of a few suggestions. Then finish the story:</p> <p>Kent did run after Jed. But instead of hitting Jed, Kent asked him if he had any work left to do that day. Jed nodded.</p> <p>Kent offered to help Jed with his work if Jed would help rake the leaves into a pile again. Jed agreed, and the two boys had a good time working together.</p>
Discussion	<p>Explain that if we forgive others and treat them kindly, as Kent treated Jed, we will feel happy inside. If we do not forgive, we will continue to feel hurt or angry, and we will not be happy. We need to forgive others so we can be happy.</p> <p>Describe some situations to the children, and discuss whether or not the child in the situation showed forgiveness. If the child described did not show forgiveness, ask the children what the child could do to show forgiveness and feel happy inside.</p> <p>Use the situations below or create some of your own:</p> <ol style="list-style-type: none"> 1. Jan had just finished drawing a beautiful picture when her little brother came and scribbled all over it with a crayon. Jan was so upset that she yelled and slapped her brother’s hand. <ul style="list-style-type: none"> • Did Jan show forgiveness? • How do you think Jan felt inside? • What could Jan do to show forgiveness to her brother?

2. On the playground, Donna came up to Cali and pushed her down. Donna ran away laughing. The next day, Donna fell out of the swing and hurt her knee. Cali rushed over and helped her up.
 - Did Cali show forgiveness?
 - How do you think Cali felt inside?
3. When Chad was waiting to get a drink of water from the fountain, the boy in front of him turned and threw water on him. Chad's face was all wet, but he just turned and walked away without saying a word. The next day when Chad was getting a drink, the same boy walked by. Chad could have thrown water on the boy, but he didn't.
 - Did Chad show forgiveness?
 - How do you think Chad felt inside?

Summary

Review activity

List the numbers from 1 to 8 on the chalkboard. Let the children take turns erasing a number and answering the review question that corresponds with that number. If you have a large class, you may need to make up more questions.

1. What does it mean to forgive others?
2. How did Jesus Christ act toward the soldiers who hung him on the cross?
3. What did Jesus Christ ask Heavenly Father to do for the soldiers?
4. How do you think Kent felt when Jed kicked the pile of leaves?
5. How did Kent show forgiveness to Jed?
6. How do you think Kent felt when he forgave Jed?
7. How do you think Jed felt when Kent was kind to him instead of seeking revenge?
8. How will we feel when we forgive those who have been unkind to us?

CTR chart and ring

Display the CTR chart. Have the children repeat the words on the chart. Help the children understand that when we forgive others as Jesus did we are choosing the right.

Have the children look at their CTR rings if they are wearing them. Tell them that their rings can help remind them to choose the right by forgiving others.

Testimony

Testify that we can be happy when we forgive others and treat them kindly. Tell about a time when you chose the right and forgave someone. Explain how you felt toward that person because you were willing to forgive.

If time allows, let the children talk about times when they have forgiven someone.

Encourage the children to make a special effort to forgive others this week. Suggest that the children discuss forgiveness with their families.

Invite a child to give the closing prayer. Suggest that the child ask Heavenly Father to help the children forgive others.

**Enrichment
Activities**

Choose from the following activities those that will work best for the children in your class. You can use them in the lesson itself or as a review or summary. For additional guidance, see “Class Time” in “Helps for the Teacher.”

1. Bring a large bag and some rocks. Discuss with the children how we often become angry or seek revenge when people have been unkind to us. During this discussion, put the rocks in the bag one by one.

When the bag has a number of rocks in it, let the children take turns carrying it around. Ask them to try to clap their hands or give someone a hug while carrying the bag. Explain that being angry at others for the unkind things that they have done is like carrying a bag of rocks. It is a heavy burden for us.

Have the children say “I will forgive” a few times as you take the rocks out of the bag. Then have the children carry the bag again. Explain that when we forgive others, we no longer have to carry a heavy burden. We feel much happier when we forgive.

2. Sing or say the words to “Do As I’m Doing” (*Children’s Songbook*, p. 276). The words to this song are included at the back of the manual.

Repeat the song a few times, letting the children take turns choosing an action to do. Remind the children that when we follow someone, we do what they do. If we want to be followers of Jesus Christ, we should do what he does, including showing forgiveness to those who are unkind to us.

3. Tell the story of Joseph and his brothers, as found in Genesis 37 and 41–45. You may want to have the children act out the story. Discuss with the children how Joseph forgave his brothers (see Genesis 45:1–15).
4. Make for each child a copy of the picture at the end of the lesson. Give the children crayons or pencils and have them draw happy faces on the children in the picture. Then let them color the pictures. Ask the children to take the pictures home and put the pictures where they will remind them to forgive others.
5. Have the children role-play the story about Kent and the three situations on pages 219–20 of the lesson (in the first situation, have the children act out how Jan could show forgiveness to her brother). Or create some similar situations more appropriate for the children in your class and have the children act them out.

Forgiving Makes Us Happy



Jesus Christ Is Our Savior

Lesson

41

Purpose To help each child understand that because Jesus Christ was resurrected, everyone will be resurrected.

Preparation

1. Prayerfully study Matthew 27:45–66, 28:1–8, Luke 24:13–46, and John 19:30, 20:11–18. See also *Gospel Principles* (31110), chapters 11 and 12.
2. Cut a sheet of paper the same size as picture 2-65, The Resurrected Jesus Christ (Gospel Art Picture Kit 239; 62187), into eight pieces. Number the pieces from 1 to 8. Cover picture 2-65 as illustrated by carefully fastening the pieces to the picture with paper clips or small pieces of tape.

1	2
3	4
5	6
7	8

3. Prepare to sing or say the words to the first verse of “He Is Risen!” (*Hymns*, no. 199), or bring a recording of this song.
4. Materials needed:
 - a. A Bible.
 - b. Cutout 2-5, scene of the Crucifixion; cutout 2-6, wrapping Jesus’ body; cutout 2-7, tomb; cutout 2-8, large stone; cutout 2-9, guards; cutout 2-10, angel; cutout 2-11, women with ointments; cutout 2-12, Jesus resurrected. Stack these cutouts in the order they are to be used in the lesson.
 - c. Picture 2-2, Family with a Baby (62307); picture 2-35, Christ and the Children (Gospel Art Picture Kit 216; 62467); picture 2-62, Mary and the Resurrected Lord (Gospel Art Picture Kit 233; 62186); picture 2-63, On the Road to Emmaus; picture 2-64, Jesus Shows His Wounds (Gospel Art Picture Kit 234; 62503).
5. Make the necessary preparations for any enrichment activities you want to use.

**Suggested
Lesson
Development**

Invite a child to give the opening prayer.

Follow up with the children if you encouraged them to do something during the week.

Jesus Christ Did Something for Us That We Could Not Do

Attention activity

Show picture 2-2, Family with a Baby. Have the children think about when they first came to earth as babies.

- What did your parents (or other family members) do for you when you were a baby that you could not do for yourself?

Help the children think of things their parents (or other family members) did for them. Make sure each child has a chance to name at least one thing.

- What do your parents (or other family members) do for you now that you cannot do for yourself?
- Why do they do these things for you?

Explain that our parents and other family members are happy to do things for us that we cannot do for ourselves because they love us and want to help us.

Discussion

Explain that someone else loves us very much and was willing to do something for us that we could not do for ourselves.

Show picture 2-35, Christ and the Children.

- Who is this person who loves us?

Explain that before we came to this earth, Jesus Christ offered to be our Savior. That meant he was willing to die and be resurrected so that we could live again and return to our Father in Heaven. Jesus was the only person with the power to do this for us. We could not do it for ourselves.

- What does it mean to be resurrected?

Explain that when we die, our spirits leave our physical bodies. After Jesus died, his spirit and his physical body came back together as a resurrected body that would live forever. Because Jesus died and was resurrected, we will be resurrected too.

Jesus Christ Was Resurrected

Teacher presentation

Explain that the resurrection of Jesus Christ, our Savior, was such an important event that we celebrate a special day every year to help us remember what happened.

- What do we call this special day? (Easter.)

Remind the children that at Easter time they learned about the resurrection of Jesus Christ.

Scripture story with cutouts

Tell the story of Jesus Christ's crucifixion, burial, and resurrection (see Matthew 27:45, 57–66; 28:1–6; and John 19:30). Let the children hold up the cutouts at the appropriate times.

Have a child hold up cutout 2-5, scene of the Crucifixion.

Explain that Jesus was placed on the cross sometime before noon. At noon the sun was hidden from view, and darkness spread over the land for three hours (see Matthew 27:45). Christ's pain was more terrible than we could stand. Christ could have chosen not to suffer and die, but he had promised Heavenly Father that he would come to earth and suffer and die for us.

Tell the children that the earth trembled and shook. Those who were watching in the darkness heard Jesus cry out, "It is finished" (John 19:30). His suffering had ended. He bowed his head and died. His spirit left his body.

- How do you think Jesus' friends and disciples felt after Jesus was crucified?

Have the child lay down the cutout of the Crucifixion scene.

Have a child hold up cutout 2-6, wrapping Jesus' body.

Explain that Jesus' friends and disciples carefully removed his body from the cross. They wrapped his body in fine linen cloth with spices, as was the custom in those days.

Have a child hold up cutout 2-7, tomb.

Explain that the Savior's friends placed his body in a tomb. A tomb is a small room, often carved out of a large rock, in which people can be buried.

Have the child lay down the cutout of wrapping Jesus' body.

Have children hold up cutout 2-8, large stone, and cutout 2-9, guards.

Tell the children that a large stone was placed at the door of the tomb, and guards stood by the stone.

- Why were the stone and the guards placed at the door of the tomb? (See Matthew 27:62–66.)

Explain that for three days Jesus' body was in the tomb. Early on the third day, which was Sunday, the earth trembled and shook again (see Matthew 28:1–2).

Have a child hold up cutout 2-10, angel.

Explain that an angel came down from heaven and rolled back the stone from the door of the tomb.

Have the child lay down the cutout of the large stone.

- What happened to the people who were guarding the tomb? (See Matthew 28:4.)

Have the child lay down the cutout of the guards.

Have a child hold up cutout 2-11, women with ointments.

Explain that on that same Sunday morning Mary Magdalene, a follower of Jesus, and another woman visited the tomb (see Matthew 28:1). They wanted to put some ointment and spices on the body of Jesus (this was a custom of the time). When they came near the tomb, they could see that the stone had been rolled away. The tomb was empty. Jesus' body was gone.

Explain that the women saw the angel, who told them not to be afraid. Read aloud from Matthew 28:5–6 what the angel said to the women.

Have all the children lay down their cutout figures. Have a child hold up cutout 2-12, Jesus resurrected.

Explain that when the angel said, "He is risen," he was telling the women that Jesus Christ had been resurrected. His spirit had come back into his body and he was alive again.

Tell the children that Jesus' disciples and friends were very glad to hear that he was alive again.

Song

Have the child continue to hold up the cutout of Jesus resurrected while you sing or play a recording of the first verse of "He Is Risen!" Then have the child lay the cutout down.

He is risen! He is risen!
Tell it out with joyful voice.
He has burst his three days' prison;
Let the whole wide earth rejoice.
Death is conquered, man is free.
Christ has won the victory.

Jesus Christ Appeared to Mary Magdalene and to His Disciples

Discussion

Show picture 2-62, Mary and the Resurrected Lord.

Explain that Jesus Christ appeared to some of his followers after he was resurrected. The first person he appeared to was Mary Magdalene (see John 20:11–18). Mary was by the tomb crying when Jesus came to her.

- How do you think Mary felt to see Jesus and know that he was alive again?

Scripture story

Show picture 2-63, On the Road to Emmaus, and tell the story found in Luke 24:13–46.

Explain that the two disciples did not recognize Jesus when he started talking with them. The disciples told Jesus about everything that had happened that day at the tomb. When Jesus stopped to eat supper with them, he broke bread, blessed it, and gave it to the disciples. Then they realized who he was. Jesus then disappeared from their sight.

- How do you think the disciples felt after seeing Jesus?
- If you had been one of the disciples and had just seen Jesus, what would you do?

Explain that the two disciples hurried to Jerusalem to tell the other disciples they had seen Jesus. As they were telling the others about what had happened, Jesus appeared.

Read aloud Luke 24:36–37. Explain that the disciples were frightened to see Jesus because they thought he was a spirit.

Show picture 2-64, Jesus Shows His Wounds.

Explain that Jesus wanted the disciples to touch his body so they would know he was resurrected. Read aloud Luke 24:39–40.

Tell the children that Jesus also asked for some food to eat. He ate the food to show the disciples that his physical body of flesh and bones had been joined with his spirit again into a resurrected body (see Luke 24:41–43).

Because Jesus Christ Was Resurrected, We Will Be Resurrected

Teacher presentation

Tell the children that Jesus Christ, our Savior, promised that all people could live again after they die. Each of us will be resurrected just as Jesus was and have a wonderful resurrected body like his. Because he loves us, Jesus made this possible.

Activity

Show the picture covered with the eight pieces of paper. Explain that hidden behind the papers is a special picture. Have the children take turns choosing a number from 1 to 8. Ask the corresponding question and allow the class to answer (help the children as needed). After the class answers each question, have a child remove the appropriate piece of paper, revealing part of the picture.

Use the following questions for the activity (or create some of your own):

1. Who will be resurrected? (Everyone.)
2. What does it mean to be resurrected? (To live again; to have our body and spirit joined again after death.)
3. What did the angel mean when he said, “He is risen”? (Jesus Christ had been resurrected.)
4. What are some of the things Jesus Christ did after he was resurrected? (He walked, talked, ate food, appeared to Mary Magdalene and to his disciples, let the disciples feel his hands and feet.)
5. Who is our Savior? (Jesus Christ.)
6. To whom did Jesus Christ appear after he was resurrected? (To Mary Magdalene and many of his disciples.)
7. Is Jesus Christ living now? (Yes, in heaven with Heavenly Father.)
8. Why was Jesus willing to die and be resurrected for us? (Because he loves us and wants us to be able to live again with him and Heavenly Father.)

When the entire picture is uncovered, explain that this is a painting of the resurrected Jesus Christ. When we see this picture, we can remember that because Jesus was resurrected everyone will be resurrected.

Summary

Testimony

Share your feelings of love for Jesus Christ, and bear your testimony about him and his resurrection. Remind the children that the news “He is risen” is good news for everyone.

Invite a child to give the closing prayer. Suggest that the child thank Heavenly Father for sending his Son, Jesus Christ, who made it possible for us to live again after we die.

Enrichment Activities

Choose from the following activities those that will work best for the children in your class. You can use them in the lesson itself or as a review or summary. For additional guidance, see “Class Time” in “Helps for the Teacher.”

1. Review the hand and glove object lesson from lesson 3 (see page 13). Continue the analogy by explaining that dying is like taking the hand out of the glove. The body (like the glove) cannot move, but the spirit (like the hand) is still alive. At resurrection the spirit and the body are reunited, and both are alive again.
2. Have the children stand and repeat the third article of faith with you. Explain that because Jesus Christ died and was resurrected, we will also be resurrected, and if we keep the commandments, we will be able to live with Jesus and Heavenly Father again someday. You may want to help the children memorize this article of faith.
3. Sing or say the words to “Did Jesus Really Live Again?” (*Children’s Songbook*, p. 64). Help the children do the actions indicated:

Did Jesus really live again (*hold hands out with palms up*)?
Yes, when the third day came (*hold up three fingers*),
He wakened and he left the tomb (*walk in place*);
He called Mary's name (*cup hands around mouth*).

Did Jesus come to those he loved (*put hands over heart*)?
Yes, people touched his feet (*bend over and touch feet*),
And of the fish and honeycomb
He did truly eat (*pantomime eating*).

And there were nailprints in his hands (*point to hand*)
And a spear wound in his side (*point to side*).

Did Jesus really live again
After he had died (*hands out, palms up*)?
Oh yes! And so shall I (*nod head*)!

4. With the approval of your Primary president, invite a ward or branch member to come to class and share his or her love for the Savior and testimony of the Resurrection.
5. Ask the children to close their eyes and pretend they are blind. Explain that when we are resurrected, there will be no more blindness or any other disabilities. Our bodies will be perfect. Everyone will be able to see and hear and run; no one will have any physical problems. No one will get sick. Ask the children to open their eyes, and talk about how wonderful it will be to have perfect healthy bodies.

The Church of Jesus Christ Is on the Earth

Lesson 42

Purpose To help each child understand that The Church of Jesus Christ of Latter-day Saints is the same church that Christ organized when he was on the earth.

- Preparation**
1. Prayerfully study Doctrine and Covenants 115:4. See also *Gospel Principles* (31110), chapters 16 and 17.
 2. Prepare to sing or say the words to the first verse of “Tell Me the Stories of Jesus” (*Children’s Songbook*, p. 57) and “The Church of Jesus Christ” (*Children’s Songbook*, p. 77).
 3. Study the world map found at the end of the lesson and identify a few locations familiar to the children, including your own state or country.
 4. The pictures displayed on the chalkboard, wall, or floor during the lesson should end up looking like this:

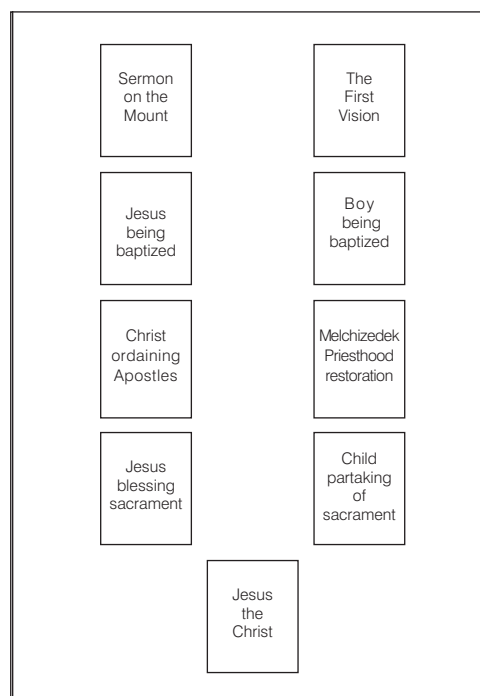

5. Materials needed:
 - a. A Bible and a Doctrine and Covenants.
 - b. Tape or other adhesive (optional).
 - c. Picture 2-3, Jesus the Christ (Gospel Art Picture Kit 240; 62572); picture 2-19, John the Baptist Baptizing Jesus (Gospel Art Picture Kit 208; 62133); picture 2-20, Boy Being Baptized (62018); picture 2-37, Sermon on the Mount (Gospel Art Picture Kit 212; 62166); picture 2-38, The First Vision (Gospel Art Picture Kit 403; 62470); picture 2-66, Christ Ordaining the Apostles (Gospel Art Picture Kit 211; 62557); picture 2-67, Jesus Blessing

the First Sacrament; picture 2-68, Melchizedek Priesthood Restoration (Gospel Art Picture Kit 408; 62371); picture 2-69, Child Partaking of the Sacrament; picture 2-70, Children from Around the World.

6. Make the necessary preparations for any enrichment activities you want to use.

**Suggested
Lesson
Development**

Invite a child to give the opening prayer.

Follow up with the children if you encouraged them to do something during the week.

Jesus Christ Organized His Church in the Holy Land

Attention activity

Show the children the world map found at the end of the lesson.

- What is this? (A map.)

Briefly discuss maps and what they are used for. Show the children where they live on the map. Point out some other places the children might be familiar with, such as where a missionary is from or where one is serving, or where a new family in the ward or branch moved from.

Explain that on this map is an area often called the Holy Land. Point out this area. Explain that this is where Jesus Christ grew up, taught people the gospel, and organized his church. Remind the children that in Primary this year they have learned many things about Jesus and his teachings to the people in the Holy Land.

Teacher presentation

Show the Bible and open it to the New Testament. Remind the children that this book of scripture contains stories about Jesus Christ and the people of the Holy Land. We can read in the New Testament about how Jesus organized his church in the Holy Land.

Picture activity

Tell the children that you are going to discuss some parts of Jesus Christ's church as he organized it in the Holy Land when he was on the earth. (You may want to point out that Jesus organized his church the same way among the Nephites in America when he visited them after his crucifixion.)

Show picture 2-37, Sermon on the Mount, and have a child place it in the top left corner of the chalkboard, on the wall, or on the floor in front of the class.

- What does this picture show? (Jesus Christ teaching the people.)
- What are some of the teachings of Jesus that you remember?

Explain that Jesus loved the people he taught and wanted them to know the gospel, the things Heavenly Father wanted them to do. One reason Jesus organized his church was to help the people learn the gospel. Explain that *organize* means to gather together in an orderly way.

- Why did Jesus want the people to have the gospel? (He loved them and wanted them to know how to live with Heavenly Father again.)

Show picture 2-19, John the Baptist Baptizing Jesus, and have a child place it below the picture of the Sermon on the Mount.

Ask the children to tell you what they know about the picture. Explain that Jesus set the example of how we should be baptized. Baptism by immersion by someone who holds the priesthood is an important part of Jesus' church.

Show picture 2-66, Christ Ordaining the Apostles, and have a child place it below the baptism picture.

Explain that Jesus Christ chose twelve men to help lead his church (not all the men are shown in the picture). These men were called Apostles. Jesus gave them the priesthood to help them lead his church and serve people.

Show picture 2-67, Jesus Blessing the First Sacrament, and have a child place it below the picture of the Apostles.

Have the children tell what they know about the picture. Remind the children that Jesus Christ gave the people the sacrament to help them remember him.

Show picture 2-3, Jesus the Christ, and have a child place it below the picture of the first sacrament.

Tell the children that Jesus wanted everyone to know that the true church was the Church of Jesus Christ.

Song

Have the children stand and sing or say the words to the first verse of "Tell Me the Stories of Jesus" with you.

Tell me the stories of Jesus I love to hear,
 Things I would ask him to tell me if he were here.
 Scenes by the wayside, tales of the sea,
 Stories of Jesus, tell them to me.

Jesus Christ Organized His Church for Us

Teacher presentation

Explain that the Apostles led the Church after Christ died. After the Apostles died, however, the people began to forget Jesus and the Apostles. They did not obey the commandments or follow Jesus' teachings anymore. Soon the Church of Jesus Christ was no longer on the earth. Hundreds of years went by and there were many different churches, but none of them had the true priesthood.

Tell the children that Heavenly Father and Jesus still loved all the people on the earth. They wanted the Church of Jesus Christ to be on the earth again so people could learn the gospel.

Map

Display the world map again and tell the children that in 1820 Heavenly Father and Jesus Christ appeared to Joseph Smith, who was living in New York, in the United States. Show the children where New York is located on the map.

Picture activity

Show picture 2-38, The First Vision, and have a child place it next to the picture of the Sermon on the Mount.

Have the children tell what they know about the picture. Explain that Jesus commanded Joseph Smith to organize the Church of Jesus Christ, just as Jesus himself had organized it when he was on the earth.

Show a copy of the Doctrine and Covenants (or show the title page of the Doctrine and Covenants in the triple combination). Point out that just as the New Testament contains the teachings of Jesus when he was on the earth, the Doctrine and Covenants contains teachings Jesus has given to Joseph Smith and other prophets of our day.

Show picture 2-20, Boy Being Baptized, and have a child place it next to the picture of Jesus being baptized.

Have the children tell about this picture. Point out that the child is being baptized by immersion (being completely covered by water) by someone who holds the priesthood, just as Jesus was baptized.

Show picture 2-68, Melchizedek Priesthood Restoration, and have a child place it next to the picture of Jesus ordaining his Apostles.

Point out Peter, James, and John in the picture of the restoration of the Melchizedek Priesthood. Explain that Peter, James, and John were three of the original Apostles who were given the priesthood by Jesus Christ. Tell the children that Jesus had Peter, James, and John return to the earth and give the priesthood to Joseph Smith and Oliver Cowdery. Jesus knew that we would need the priesthood just as the original members of his church needed it.

Show picture 2-69, Child Partaking of the Sacrament, and have a child place it next to the picture of Jesus blessing the first sacrament.

- What is happening in this picture?
- Why do we take the sacrament?

Point out that Jesus Christ has given us the sacrament for the same reason he gave it to the Apostles in the Holy Land: to help us remember him.

Move picture 2-3, Jesus the Christ, so it is between the two rows of pictures.

Explain that we are members of Jesus Christ's church, just as his followers in the Holy Land were.

Scripture

- What is the name of Jesus Christ's church today?

Read aloud Doctrine and Covenants 115:4. Explain that *latter-day* means the time we now live in and *saints* are people who obey the teachings of Jesus.

Have the children stand and say "I belong to The Church of Jesus Christ of Latter-day Saints" together a few times.

Teacher presentation

Briefly compare the two columns of pictures, emphasizing that Jesus' church is the same today as it was in the Holy Land. Jesus has given his teachings to us just as he gave them to the people in the Holy Land.

Map

Show the world map again. Point out the Holy Land again and explain that when Jesus was on the earth, most members of his church lived in the Holy Land.

- Where do the members of Jesus Christ's church live today?

Teacher presentation

Show picture 2-70, Children from Around the World, and explain that members of The Church of Jesus Christ of Latter-day Saints live all over the world. Point out that the children in the picture come from many different countries. Explain that Jesus wants all people, not just the people in one or two countries, to learn his teachings and belong to his church.

Song

Sing or say the words to "The Church of Jesus Christ."

I belong to The Church of Jesus Christ of Latter-day Saints.
I know who I am. I know God's plan.
I'll follow him in faith.

I believe in the Savior, Jesus Christ.
 I'll honor his name.
 I'll do what is right; I'll follow his light.
 His truth I will proclaim.

Summary

Matching game

Remove all the pictures except picture 2-3, Jesus the Christ, from the columns on the chalkboard, table, or floor. Mix up the pictures and place them face down (or face up for younger children) on the floor in two columns.

Tell the children that the object of this game is to match the pictures. One at a time, have each child turn over two pictures. If the pictures match (for example, the picture of Jesus being baptized matches the picture of the boy being baptized), have the child tell what part of the church of Jesus Christ is represented by the pictures. If the pictures do not match, have the child turn them face down again in the same positions. (If you think the children will be distracted by the pictures on the back sides of the pictures to be matched, place plain pieces of paper over the back pictures.)

Continue until all four matches have been made. If you have a large class, you may want to mix the pictures up again and repeat the game so everyone has an opportunity to make a match.

Testimony

Testify that The Church of Jesus Christ of Latter-day Saints is the same church that Jesus organized when he was on the earth. Tell the children your feelings about an aspect of the gospel discussed in the lesson today (baptism, priesthood, or the sacrament).

Encourage the children to tell their families about what they have learned today. You may want to ask a few questions to help the children quickly review the ideas taught in the lesson.

Invite a child to give the closing prayer. Suggest that the child thank Heavenly Father for The Church of Jesus Christ of Latter-day Saints.

Enrichment Activities

Choose from the following activities those that will work best for the children in your class. You can use them in the lesson itself or as a review or summary. For additional guidance, see "Class Time" in "Helps for the Teacher."

1. Help the children memorize the first part of the sixth article of faith: "We believe in the same organization that existed in the Primitive Church." Explain that *the Primitive Church* means the Church in the Holy Land during the time Jesus was on the earth.
2. Give the children paper and crayons or pencils and have them draw pictures of themselves at church or of the building they meet in for church. Help the children understand that the Church is more than just a building. It is an organization that helps teach us how to live so we can return to be with Heavenly Father and Jesus Christ someday.



Jesus Christ Will Come Again

Lesson 43

Purpose To help each child want to prepare for Jesus Christ's second coming by following Jesus' teachings.

- Preparation**
1. Prayerfully study Matthew 24:36, Luke 24:50–53, and Acts 1:3, 9–11. See also *Gospel Principles* (31110), chapter 43.
 2. Make a copy of the “Preparing for Jesus to Come” game board, found on the last pages of the manual (if it is not possible to make a copy, carefully remove the pages from the manual). Paste the game board onto cardboard or stiff paper. Save this game board for use with future classes.

If your class is large, you may want to make a second copy of the game so two groups can play at the same time. Ask a Primary leader or a parent of one of the children to come to class and supervise the second game.
 3. For the game, cut twelve small pieces of paper. Write a number on each paper, using the numbers 1 through 6 twice. Fold the papers and put them in a container.
 4. Prepare to tell about a time when someone close to you went away for a while. Plan to talk about how you missed the person and how you prepared for the person's return.
 5. Prepare to sing or say the words to the second verse of “When He Comes Again” (*Children's Songbook*, p. 82).
 6. Materials needed:
 - a. A Bible.
 - b. A small object, such as a button or rock, for each child. These objects will be used as markers in the game; each object must be different (in color, shape, or size) so the children can recognize their own markers.
 - c. Picture 2-62, Mary and the Resurrected Lord (Gospel Art Picture Kit 233; 62186); picture 2-64, Jesus Shows His Wounds (Gospel Art Picture Kit 234; 62503); picture 2-65, The Resurrected Jesus Christ (Gospel Art Picture Kit 239; 62187); picture 2-71, The Ascension of Jesus (Gospel Art Picture Kit 236; 62497).
 7. Make the necessary preparations for any enrichment activities you want to use.
-

**Suggested
Lesson
Development**

Invite a child to give the opening prayer.

Follow up with the children if you encouraged them to do something during the week.

We Prepare for the Return of Our Loved Ones

Attention activity

Tell about a time when someone close to you went away for a period of time. Explain how you felt when this person left and how eager you were for him or her to return. Tell about any preparations you made for your loved one's homecoming and how you felt to see this person again.

Help the children think of times when someone they love went away for a while. Possibilities could include when a parent went on a trip, when a mother went to the hospital to have a baby, or when a sibling or other family member went on a mission. Discuss with the children the feelings they had when these people left and when they came home. Emphasize that we miss our loved ones when they go away, and we are happy when they come home. Let the children talk about any preparations they and their families made for these people's homecomings, such as cleaning and decorating the home, cooking special food, or wearing special clothes.

Jesus Christ Will Return

Teacher presentation

Explain that when Jesus Christ lived on the earth he had friends who loved him very much. These friends followed him and listened to his teachings. Because they did what he taught them to do, they were called his disciples.

Explain that Jesus loved his disciples. He helped them learn what they needed to do to live with him and Heavenly Father again. He helped them understand the difference between right and wrong so they could choose the right.

Picture discussion

Show picture 2-62, Mary and the Resurrected Lord, and picture 2-64, Jesus Shows His Wounds. Remind the children that a few weeks ago (lesson 41) they learned about Jesus visiting his disciples after he was resurrected. Let the children talk about the pictures for a few moments.

Explain that Jesus visited and taught his disciples for forty days after he was resurrected (see Acts 1:3). He wanted to be sure they knew he was alive again and understood his teachings. Jesus wanted his disciples to obey his teachings even when he was no longer with them.

Scripture story

Show picture 2-71, The Ascension of Jesus. Tell in your own words the story of Christ's ascension into heaven, as described in Luke 24:50–53 and Acts 1:9–11. Emphasize the following points:

1. Jesus gave the disciples a blessing.
2. Jesus left his disciples and rose up into a cloud to join Heavenly Father in heaven.
3. The disciples stood and watched until Jesus disappeared.

Tell the children that as the disciples stood looking up toward heaven, two angels dressed in white appeared beside them.

Read aloud what the angels said to the disciples in Acts 1:11 (beginning with *Why stand ye*).

Explain that the angels told the disciples that Jesus Christ would someday come back to earth in the same way he left. Tell the children that we refer to this as the Second Coming.

Point out that we do not know exactly when Jesus will come again. Only Heavenly Father knows the exact time (see Matthew 24:36). But we do know that someday Jesus will return to the earth to live.

Discussion

Show picture 2-65, The Resurrected Jesus Christ.

Explain that when Jesus comes again he will live among the people on earth. Everyone will know that he is Jesus Christ, our Savior, and will worship him.

- Would you like to be here when Jesus comes again? Why?

Discuss with the children how wonderful it will be on earth when Jesus comes again. People will be able to see Jesus, to walk and talk with him, and to have him put his loving arms around them. Point out that after Jesus comes, everyone will be friends. There will be no evil people. We will not need to lock our doors because everything and everybody will be safe. There will be no disease to cause us sickness or pain, and all the animals will be friends with us and with each other.

Review activity

Ask the children the following questions about the Second Coming. Tell them to stand when they know the answer to a question. When at least a few children are standing, call on one of them to answer the question. If no one stands, or if the children seem confused or unsure of the answers, take time to review the information again.

- For how many days did Jesus Christ visit his disciples after he was resurrected? (Forty.)
- Who knows when Jesus will come again? (Only Heavenly Father. No one on earth knows.)
- Will there be wars or fighting after Jesus comes again? (No. Everyone on earth will be friends.)
- What will happen to people who are sick or disabled when Jesus comes again? (They will be healed. There will be no more sickness or pain when Jesus returns to the earth.)
- What will the animals be like when Jesus comes again? (They will all be friendly to us and to each other.)

We Can Prepare for Jesus Christ's Second Coming

Teacher presentation

Remind the children of the preparations they made when their loved ones returned home. Explain that we must also prepare for Jesus Christ's return to the earth. We can prepare by learning and following Jesus' teachings.

Point out that if we are prepared, we will be happy to see the Savior. He wants everyone to live with him again, but only those who follow his teachings and choose the right will be able to do so. Jesus helped his disciples learn what they had to do to live with him again, and he has also given us teachings to help us be prepared when he comes again.

Song

Sing or say the words to the second verse of "When He Comes Again." Help the children do the suggested actions:

I wonder, when he comes again,
 Will I be ready there (*place finger on temple*)
 To look upon his loving face
 And join with him in prayer (*fold arms as if praying*)?

Each day I'll try to do his will
And let my light so shine (*hold arms over head in a circle*)
That others seeing me may seek
For greater light divine (*use hand to shade eyes*).
Then, when that blessed day is here,
He'll love me and he'll say (*hug self*),
"You've served me well, my little child;
Come unto my arms to stay" (*hold arms out*).
(© 1952, 1980 by Mirla Greenwood Thayne. Used by permission.)

Game

Point out that preparing for Jesus' second coming is not something we can do in one day. We must prepare our whole lives by following the teachings of Jesus.

Show the children the "Preparing for Jesus to Come" game board. Tell them that this game will remind them of some of the things they can do to prepare to live with Jesus.

Show how the game describes good things we can do to follow Jesus. These things lead toward the area labeled "Preparing for Jesus to Come." Point out that the game also shows some wrong things we might do. These things lead toward the area labeled "Not Preparing for Jesus to Come."

Give each child a small object to use as a marker in the game. Then explain the following rules:

1. The object of the game is to get from the arrow marked "Start" to the area labeled "Preparing for Jesus to Come."
2. Take turns.
3. On your turn, choose a piece of paper from the container and move your marker the number of spaces indicated on the paper. Then refold the paper and put it back in the container.
4. As you land on a square, you or the teacher will read aloud what is written on the square. Tell something you can do to follow this teaching, or explain why it is important to do the thing described on the square. If you land on a square that describes a wrong thing, explain what you should do instead of what is written on the square. If you need help, your teacher will give you some suggestions.
5. The arrow on each square indicates which direction to go on your *next* turn.

When a child lands on a square that points away from "Preparing for Jesus to Come," help the children understand that when we do wrong things we are not following Jesus' teachings, but we can change directions by doing what is right.

Play the game until everyone has made it to "Preparing for Jesus to Come" or until the class period is nearly over.

Summary

Testimony

Testify that Jesus Christ will come to the earth again, although we do not know when. Tell the children how much you want to follow the teachings of Jesus so you can have the privilege of seeing him when he comes again. Express your desire that each child in the class follow the teachings of Jesus so you can all be together with him.

CTR ring

Have the children look at their CTR rings if they are wearing them. Remind the children that their rings can help them remember to choose the right and follow the teachings of Jesus.

Ask each child to tell the class something he or she will do during the coming week to prepare for the second coming of Jesus.

Invite a child to give the closing prayer. Suggest that the child ask Heavenly Father to help the class members prepare for the coming of Jesus Christ.

Enrichment Activities

Choose from the following activities those that will work best for the children in your class. You can use them in the lesson itself or as a review or summary. For additional guidance, see “Class Time” in “Helps for the Teacher.”

1. Sing or say the words to both verses of “When He Comes Again” (*Children’s Songbook*, p. 82). The words to the second verse are printed on pages 237–38.

I wonder, when he comes again,
Will herald angels sing?
Will earth be white with drifted snow,
Or will the world know spring?
I wonder if one star will shine
Far brighter than the rest;
Will daylight stay the whole night through?
Will songbirds leave their nests?
I’m sure he’ll call his little ones
Together round his knee,
Because he said in days gone by,
“Suffer them to come to me.”

(© 1952, 1980 by Mirla Greenwood Thayne. Used by permission.)

2. Explain that the tenth article of faith tells about Jesus Christ’s second coming. Help the children memorize the phrase “We believe . . . that Christ will reign personally upon the earth.” Explain the meaning of the phrase to the children.
3. Show the children an oil lamp or a simple drawing of an oil lamp. Explain that Jesus taught us the importance of preparing for his coming in a story about ten virgins (or girls) and their lamps. Tell the parable of the ten virgins, as found in Matthew 25:1–13. Explain that oil lamps cannot give light unless they have oil to burn. Emphasize that because the five foolish girls did not prepare, they were not permitted to go to the wedding.

Explain that the Savior compared the wedding to his second coming. The girls getting oil for their lamps can be compared to us preparing to be with Jesus. If we are not prepared when he comes, we will not be able to live with him.

Ask the children to tell ways they can prepare for the coming of Jesus (you may need to give them some suggestions, such as those used in the game). Help them understand that by choosing the right we are preparing for the second coming of Jesus Christ.

4. Write *I Am Preparing for the Coming of Jesus Christ* at the top of a badge for each child. Have each child use crayons or pencils to draw on the badge a picture of himself or herself doing something to prepare for the coming of Jesus. Pin the badges on the children or help them put string or yarn through a hole at the top of each badge to make a necklace.

I Can Show Love for Animals

Purpose	To encourage each child to show respect and kindness to all living creatures.
----------------	---

Preparation	<ol style="list-style-type: none"> 1. Prayerfully study Genesis 6:11–7:24, Isaiah 11:6–9, and Luke 12:6. 2. Make a copy of the animal squares found at the end of the lesson (if it is not possible to make a copy, carefully remove the page from the manual). Cut the squares apart. Save these squares for use with future classes. 3. Prepare to sing or say the words to the refrain of “All Things Bright and Beautiful” (<i>Children’s Songbook</i>, p. 231). 4. Prepare to tell about a time when you showed or saw someone else show kindness to an animal. 5. Materials needed: <ol style="list-style-type: none"> a. A Bible. b. Paper and crayons for each child. c. Picture 2-72, Noah and the Ark with Animals (Gospel Art Picture Kit 103; 62305); picture 2-73, Creation—Living Creatures (Gospel Art Picture Kit 100; 62483); picture 2-74, Salt Lake Tabernacle (Gospel Art Picture Kit 503; 62490). 6. Make the necessary preparations for any enrichment activities you want to use.
--------------------	--

**Suggested
Lesson
Development**

Invite a child to give the opening prayer.

Follow up with the children if you encouraged them to do something during the week.

Animals Are Important

Attention activity

Mix up the animal squares and lay them face down in a grid on the table or floor. Invite the children to take turns turning over two squares, one at a time, and placing them picture side up. If the two animals match, have the child put them together in an “animal parade” to the side of the grid. If the two animals do not match, have the child turn the cards back over in the same places. Continue until all the animals have been matched and placed in the animal parade.

Ask the children if the pairs of animals in the parade remind them of a story in the Bible. If the children do not think of the story of Noah and the ark, give them a few clues such as the following:

- The Lord told someone to build something.
- The animals came in pairs.
- It rained for forty days and forty nights, flooding the earth.

Scripture story Show picture 2-72, Noah and the Ark with Animals, and review the story found in Genesis 6:11–7:24. Explain that Jesus Christ wanted the animals to be saved from the Flood. He told Noah to put the animals on the ark and helped Noah know how to take care of so many different animals.

Jesus Christ Created the Animals

Picture discussion Display picture 2-73, Creation—Living Creatures.

- What animals do you see in this picture?
- What do you like about these animals?

Let the children talk about the animals for a few minutes.

- Who created these animals?

Remind the children that under Heavenly Father's direction, Jesus Christ created all the animals.

Song With the children, sing or say the words to the refrain of "All Things Bright and Beautiful."

All things bright and beautiful,
All creatures great and small,
All things wise and wonderful,
The Lord God made them all.

Scripture Remind the children that they learned in the previous lesson about Jesus Christ's second coming. Remind them that when Jesus comes again, the animals will all be friendly and peaceful. Read aloud Isaiah 11:6–7 to describe how the animals will get along when the Savior lives on the earth again.

Heavenly Father and Jesus Christ Love All Creatures

Scripture Explain that Heavenly Father and Jesus Christ want each creature, even the smallest ones, to be happy. They consider every living creature to be important.

Read aloud Luke 12:6. Explain that this scripture tells us that even though sparrows are very small birds, Heavenly Father and Jesus still care for them.

Story Show picture 2-74, Salt Lake Tabernacle.

- Have you ever watched general conference on television or on a satellite broadcast at a church building?

Explain that general conference is broadcast from this building, called a tabernacle. This tabernacle, in Salt Lake City, Utah, was built by Latter-day Saint pioneers.

Point out the high roof and the many doors of the Tabernacle, and tell the following story in your own words:

One spring evening the doors of the Tabernacle were left open to cool the building. A small bird flew inside without anyone noticing. The bird was still inside when the doors were closed and locked.

When workers arrived the next morning to set up for a concert, they found the bird and spent several hours trying to remove it. They called specially trained people to try to capture the bird with long-handled nets.

When the manager, Brother John, arrived, he found people chasing the bird with the nets. Each time the people ran to one end of the building with the nets, the bird flew to the other end. All the doors of the Tabernacle were open for the bird to escape, but it was too terrified to notice.

The specially trained people had brought pellet guns, and they suggested using the guns to shoot the bird. Brother John did not like that idea. The gun could damage the building or the equipment inside it. More important, he did not think they should kill the bird. He remembered a talk given by President Spencer W. Kimball, the twelfth President of the Church, about not shooting little birds.

The specially trained people also suggested putting out poisoned food for the bird to eat. Brother John did not want to do that either. But he knew the bird must be removed quickly, because there was an important performance that evening.

Brother John turned away and said a short prayer: "Heavenly Father, if this sparrow is important to you, could you please let us know how to safely remove it?"

As Brother John finished his prayer, he knew what to do. He told the workers to turn off the lights in the building and close all the doors but one.

The bird had been sitting on top of the organ, but when they turned off the lights and shut the doors, the bird flew off the organ and straight out the one open door. (See Ronald D. John, "A Sparrow in the Tabernacle," *Ensign*, June 1989, pp. 24–25.)

- How did Brother John show he cared for the little bird? (He prayed about it instead of shooting or poisoning it.)
- How do you know Heavenly Father cared about the bird? (He helped Brother John know how to get it out of the Tabernacle.)

We Can Be Kind to Animals

Discussion

Explain that Heavenly Father and Jesus want each of us to care for the animals as they do.

Invite the children to talk about any pets or other animals they or their families have. (If the children do not have animals at home, they may talk about what kind of pets they would like to have.) Ask the children to tell about how they help take care of these animals. Let the children pantomime some of the things they do to care for animals, such as providing fresh water and healthy food, grooming the animals, or speaking to them kindly.

Story

Explain that the Prophet Joseph Smith, the first President of the Church, also taught kindness to animals. Tell the following story in your own words:

The Prophet Joseph Smith and some other men were camping on the bank of a small river. As the Prophet pitched his tent, he found three prairie rattlesnakes. The other men wanted to kill the snakes, but the Prophet stopped them and told them not to hurt the snakes. The men picked the snakes up with sticks and carefully carried them to the other side of the river. The Prophet told the other men that they should not kill any snakes, birds, or other animals while they were on their journey unless they needed them for food. (See *History of the Church*, 2:71–72; see also Spencer W. Kimball, *Ensign*, Nov. 1978, p. 45.)

Summary

Remind the children that Jesus Christ created all the animals and that all creatures on the earth are part of Heavenly Father's plan.

Activity	<p>Have the children stand, and help them say the words and do the actions to the following verse:</p> <p>Jesus loves all creatures (<i>hold arms outstretched</i>): Elephants, big and tall (<i>stretch up tall with arms above head</i>), The fishes in the ocean (<i>clasp hands and move them like a fish swimming</i>), The little mouse so small (<i>crouch down</i>). He loves the creeping insects (<i>make fingers of one hand "crawl" on other hand</i>), The birds that fly above (<i>flap arms like wings</i>). Gentle deer in the forest (<i>place thumbs to head with fingers spread like antlers</i>), All feel the Savior's love (<i>place hands over heart</i>).</p>
Testimony	<p>Tell about a time when you showed or saw someone else show kindness to an animal. Testify that Heavenly Father and Jesus Christ love all creatures on the earth and want us to be kind to animals.</p> <p>Encourage each child to do something kind for an animal this week.</p>
Art activity	<p>Give the children paper and crayons and let them draw pictures of what they might do to be kind to animals.</p> <p>Invite a child to give the closing prayer.</p>

Enrichment Activities

Choose from the following activities those that will work best for the children in your class. You can use them in the lesson itself or as a review or summary. For additional guidance, see "Class Time" in "Helps for the Teacher."

1. Tell in your own words the story that Brother John remembered from President Spencer W. Kimball's talk:

"I remember many times singing with a loud voice:

"Don't kill the little birds,
 That sing on bush and tree,
 All thro' the summer days,
 Their sweetest melody.
 Don't shoot the little birds!
 The earth is God's estate,
 And he provideth food
 For small as well as great.

(*Deseret Songs*, 1909, no. 163.)

"I had a sling and I had a flipper. I made them myself, and they worked very well. It was my duty to walk the cows to the pasture a mile away from home. There were large cottonwood trees lining the road, and I remember that it was quite a temptation to shoot the little birds 'that sing on bush and tree,' because I was a pretty good shot and I could hit a post at fifty yards' distance or I could hit the trunk of a tree. But I think perhaps because I sang nearly every Sunday, 'Don't Kill the Little Birds,' I was restrained. . . . I could see no great fun in having a beautiful little bird fall at my feet" (Spencer W. Kimball, in Conference Report, Apr. 1978, p. 71; see also *Ensign*, May 1978, pp. 47–48).

2. Give each child a small piece of salt dough from which to mold a favorite animal (a salt dough recipe can be found on page 43). Let the children take their animals home to show their families.
3. Allow each child to take a turn pantomiming the actions of a favorite animal. Have the other children try to guess which animal is being imitated. If the other children cannot guess the animal from the actions, the child may provide spoken clues.
4. Give the children clues about different animals. Tell the children that when they know the animal you are describing, they should raise their hands but not say anything. Ask a child with a hand raised to tell what animal the clues are about. Use the following clues or create some for animals in your area:

- I have six legs, my coat is green;
I'm the very best hopper you've ever seen. (Grasshopper.)
- I'm small and wiggly with lots of bends;
I look just alike on both my ends. (Worm.)
- My home is in the nice cool pond;
Of croaking and jumping I'm very fond. (Frog.)
- When spring has come you look for me
In my red-feathered breast high up in a tree. (Robin.)
- I have a round face and two large eyes
That can see in the dark; they call me wise. (Owl.)
- I have feet and hands, eyes, ears, and nose;
I can hang from a tree by my tail or my toes. (Monkey.)
- If you climb on my back, I'll give you a ride.
Hold on to my reins; I'm easy to guide. (Horse.)
- I can run up a tree before you can think;
My bushy tail waves good-bye, quick as a blink. (Squirrel.)
- I live on a farm and have a short curly tail
That goes wiggle-waggle for my dinner pail. (Pig.)
- I love to run and jump and play;
"Baa" is the only word I can say. (Lamb.)

(Clues adapted from "Who Am I?" *Children's Friend*, May 1956, p. 208.)

5. Review the story of Warren from lesson 2 (see page 7).
 - How did Warren show kindness to animals?
6. Repeat the matching game from the beginning of the lesson as many times as you or the children want.
7. Help the children make a simple bird feeder to take home and hang outdoors. Spread peanut butter on a pinecone or a piece of bread cut into an interesting shape. Dip the pinecone or bread in birdseed. Use string to hang the bird feeder from a tree, bush, or post. (You may know how to make other simple bird feeders using materials available in your area.)

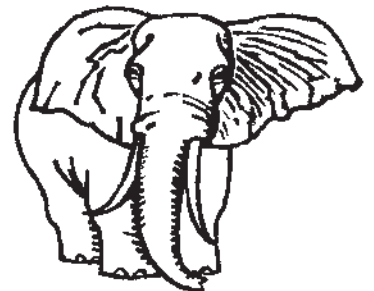
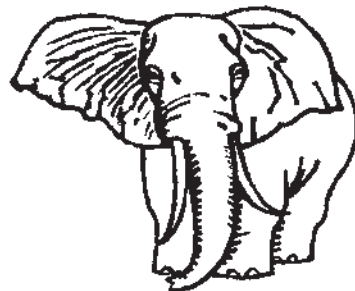
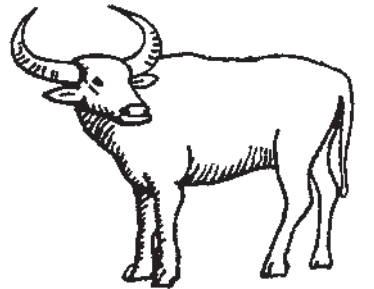
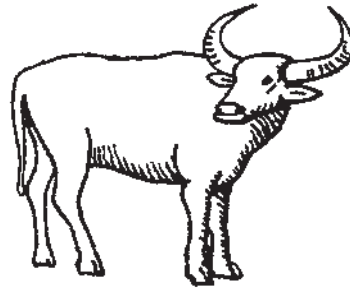
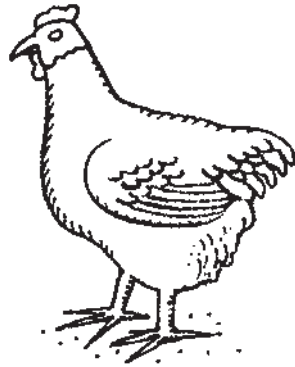
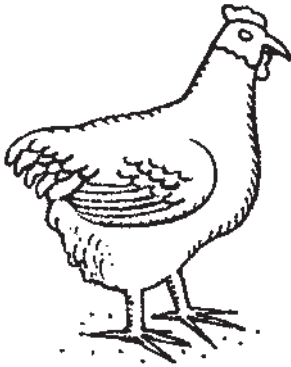
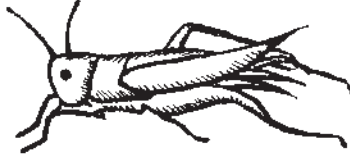
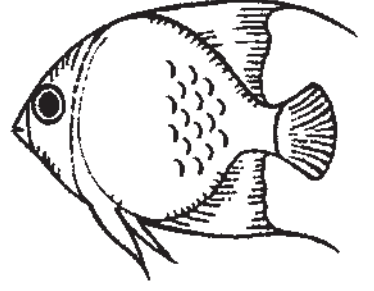
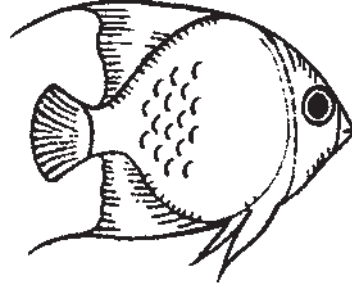
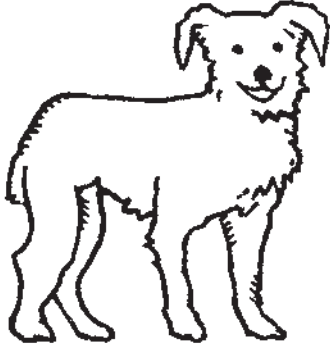
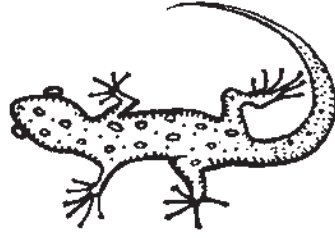
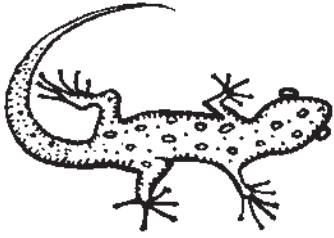

We Celebrate the Resurrection of Jesus Christ (Easter)

Lesson
45

Purpose To help each child understand that we celebrate Easter because Jesus Christ was resurrected.

Preparation

1. Prayerfully study Matthew 27:57–66; 28:1–8; Mark 15:16–20, 40–47; 16:1–11; Luke 23:44–46; and John 20:1–18.
2. Draw or obtain pictures of items related to the secular celebration of Easter in your area, such as candy, eggs, flowers, or fancy clothes. Before class, display these on the table, floor, or chalkboard. Display cutout 2-12, Jesus resurrected, among the other pictures.
3. Prepare to sing or say the words to “Did Jesus Really Live Again?” (*Children’s Songbook*, p. 64).
4. Materials needed:
 - a. A Bible.
 - b. A small sack or box.
 - c. Cutout 2-5, scene of the Crucifixion; cutout 2-6, wrapping Jesus’ body; cutout 2-7, tomb; cutout 2-8, large stone; cutout 2-9, guards; cutout 2-10, angel; cutout 2-11, women with ointments; cutout 2-12, Jesus resurrected. Stack the cutouts in the order they will be used in the story of the first Easter.
 - d. Picture 2-65, The Resurrected Jesus Christ (Gospel Art Picture Kit 239; 62187).
5. Make the necessary preparations for any enrichment activities you want to use.

Suggested Lesson Development

Invite a child to give the opening prayer.

Follow up with the children if you encouraged them to do something during the week.

We Remember Jesus Christ at Easter

Attention activity Show the pictures you have displayed on the table, floor, or chalkboard. Have the children identify one picture at a time and explain how the items pictured relate to local secular Easter customs.

After the children discuss each item, ask:

- Is this item really why we celebrate Easter? (No.)

Then have a child remove the picture and place it in a small sack or box.

Continue discussing the pictures until only the cutout of Jesus Christ remains.

- Is this really why we celebrate Easter? (Yes.)

Remind the children that Jesus Christ is the real reason we celebrate Easter. Jesus did something very wonderful for us on the first Easter.

Jesus Christ Was Resurrected on the First Easter

Scripture story
with cutouts

Tell in your own words the story of the first Easter (see Matthew 27:57–66; 28:1–8; Mark 15:16–20, 40–47; 16:1–11; Luke 23:44–46; and John 20:1–18). Let the children take turns holding up the appropriate cutouts as you tell the story. If the children know the story, let them help you tell it.

Have a child hold up cutout 2-5, scene of the Crucifixion.

Explain that the wicked people who did not like Jesus Christ had finally obtained permission from their leaders to put him to death. These people beat Jesus and made fun of him. They took him to a hill outside the city and nailed him to a cross.

Have the child put down the cutout of the Crucifixion, and have another child hold up cutout 2-6, wrapping Jesus' body.

Explain that after Jesus died, his friends showed their love for him by taking care of his body. Carefully they took it down from the cross. They wrapped it in clean, new cloth and put it in a tomb, which is a small cave or a room carved out of a rock in the hillside.

Have the child put down the cutout of wrapping Jesus' body, and have other children hold up cutout 2-7, tomb, and cutout 2-8, large stone.

Explain that after Jesus' friends laid his body in the tomb, they rolled a large stone over the doorway.

- How do you think Jesus' friends felt that evening?

Have a child hold up cutout 2-9, guards.

Tell the children that later some of the Savior's enemies placed guards at the tomb. They did this because Jesus had told the people that he would be resurrected in three days. His enemies did not believe he would be resurrected. They thought Jesus' friends would hide his body and say he was alive again.

Have a child hold up cutout 2-10, angel.

Explain that on the morning of the third day an angel came and rolled away the stone at the entrance to the tomb. The guards were very frightened, and they fell down as if they were dead.

Have the children put down the cutouts of the guards and the large stone, and have another child hold up cutout 2-11, women with ointments.

Tell the children that on the same day, which was Sunday, some women who were Jesus' friends went to the tomb. They brought spices to put on Jesus' body. This was something people at that time did to show love and respect for the person who had died.

Explain that the women wondered how they would move the heavy stone from the tomb. But when they arrived at the tomb, they saw that the stone was rolled away and Jesus' body was gone. Near the tomb they saw an angel.

- How do you think the women felt when they saw that the Savior's body was gone?
- How do you think they felt when they saw the angel?

Scripture

Read aloud from Matthew 28:5–6 what the angel said to the women.

Explain that the angel also told the women to go quickly and tell the disciples that Jesus Christ had risen from the dead (see Matthew 28:7).

Have the children put down all the cutouts, and have another child hold up cutout 2-12, Jesus resurrected.

Explain that the women did go tell the other disciples, and later the other disciples saw Jesus. He was alive again.

- How do you think the disciples felt when they knew that Jesus Christ was alive again?

Review activity

Place all the cutouts face down on the table or floor. Have the children take turns choosing a cutout and telling the applicable part of the story of Jesus' resurrection.

We Are Reminded at Easter That We Will Be Resurrected

Teacher presentation

Display picture 2-65, The Resurrected Jesus Christ.

Explain that when Jesus Christ died, his spirit left his physical body and went to heaven. After three days, his spirit came back into his physical body and his physical body was alive again. We call this being resurrected. Have the children say *resurrected* aloud several times.

Explain that Jesus was the first of Heavenly Father's children to be resurrected. Because he was resurrected, we will all be resurrected too. We may not be resurrected just three days after we die, as Jesus was, but someday we will be resurrected.

Story

Tell a story about a child who was happy when she thought about Jesus Christ and his resurrection. You may want to use the following story:

Carmen liked to play in her yard near the garden of her neighbor, Brother Schmidt. Often while Brother Schmidt worked in his garden, Carmen would talk to him. They became good friends.

One day Carmen's mother told her that because Brother Schmidt was very old, he had died. His spirit had left his physical body, and his physical body was no longer alive.

Carmen knew she would miss Brother Schmidt, but her mother reminded her of the Easter story. Carmen remembered the story of Jesus' resurrection. She knew that Jesus said we would all be resurrected and live again after we die. Carmen knew that Brother Schmidt would be resurrected too. She was happy that Jesus made it possible for us to be resurrected.

Discussion

Explain that we refer to the day Jesus Christ was resurrected as the first Easter. All over the world, people who love Jesus celebrate his resurrection on Easter.

- Why do we feel happy at Easter? (We know that we and all our loved ones will be resurrected as Jesus was.)

- What are some things we can do to remember Jesus Christ and show our happiness at Easter time? (Answers may include talking about Jesus at home, singing songs about Jesus with our families, and having special Easter lessons, programs, and songs at church.)

Summary

Song

Have the children stand and sing or say the words to “Did Jesus Really Live Again?” Help them do the actions indicated:

Did Jesus really live again (*hold hands out with palms up*)?
 Yes, when the third day came (*hold up three fingers*),
 He wakened and he left the tomb (*walk in place*);
 He called Mary’s name (*cup hands around mouth*).

Did Jesus come to those he loved (*put hands over heart*)?
 Yes, people touched his feet (*bend over and touch feet*),
 And of the fish and honeycomb
 He did truly eat (*pantomime eating*).

And there were nailprints in his hands (*point to hand*)
 And a spear wound in his side (*point to side*).
 Did Jesus really live again
 After he had died (*hold hands out with palms up*)?
 Oh yes! And so shall I (*nod head*)!

Testimony

Bear your testimony of the resurrection of Jesus Christ. Tell the children how you feel knowing that someday you and your loved ones will be resurrected.
 Encourage the children to talk about Jesus Christ’s resurrection with their families.
 Invite a child to give the closing prayer.

Enrichment Activities

Choose from the following activities those that will work best for the children in your class. You can use them in the lesson itself or as a review or summary. For additional guidance, see “Class Time” in “Helps for the Teacher.”

1. Read the picture story “The First Easter” (found at the end of the lesson) with the children. At the appropriate places, help the children fill in the words represented by the pictures. If possible, you may want to make a copy of the story for each child.
2. Bring a picture of a family member or friend of yours who has died. Show the picture to the children and talk about some of the things you did with this person and why you admire and love him or her. Express how you feel about knowing that you will be able to see this person again someday.
3. Give each child a piece of paper labeled *We Will Live Again*. Give the children crayons and ask them to draw pictures of loved ones who have died or of their families. Let the children tell the other class members about their pictures.

Remind the children that because Jesus Christ was resurrected, we will all be resurrected after we die. All our loved ones will also be resurrected someday.

4. Discuss with the children any physical or mental disabilities they are familiar with or have observed. Help the children understand that when we are resurrected, our bodies will be perfect (see Alma 40:23). No one will have any disabilities. Discuss how wonderful that will be.
5. Sing or say the words to “Jesus Has Risen” (*Children’s Songbook*, p. 70) with the children.

Jesus has risen,
Jesus, our friend.
Joy fills our hearts;
He lives again.
Praises we sing to him,
This Eastertime.
Jesus has risen,
Savior divine.
Jesus has risen,
Savior divine!

The First Easter



friends



tomb



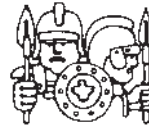

stone









soldiers









angel

When Jesus died his  were sad. They put him in a 

A large  was placed in front of the .  stood nearby to see that no one rolled the  away.

For **3** days Jesus' body lay in the . Then in the morning of the third day, an  came and rolled the  away. When the  saw the , they were afraid.

That day Jesus'  came to the . They saw that the  had been rolled away. There was an  in the . The  said, "He is not here: for he is risen."

Jesus died so that we can all live again after we die. We have Easter to remind everyone of the day Jesus arose from the dead.

Jesus Christ Is the Greatest Gift (Christmas)

Lesson

46

Purpose To help each child appreciate the great gift our Heavenly Father gave us when he sent Jesus Christ to the earth.

- Preparation**
1. Prayerfully study Matthew 2:1–12 and John 3:16.
 2. Place picture 2-41, The Birth of Jesus (Gospel Art Picture Kit 200; 62116) in a box, if possible, and wrap it as a gift. Write *John 3:16* on a tag and fasten it to the gift.
 3. Make a card for each child by folding a sheet of paper in half and writing *Merry Christmas* on the front. If possible, bring envelopes for the children to put the cards in.
 4. Draw or cut out a paper star to represent the star the Wise Men followed (a star pattern can be found at the end of the lesson).
 5. Bring simple articles of clothing (such as scarves or robes) to be used as costumes for role-playing Mary, Joseph, and the Wise Men. If costumes are not readily available, bring name tags to indicate the roles. Also bring a doll to represent Jesus and items (such as a box, jar, and vase) to represent the Wise Men's gifts.
 6. Prepare to sing or say the words to "He Sent His Son" (*Children's Songbook*, p. 34). The words to this song are included at the back of the manual.
 7. Materials needed:
 - a. A Bible.
 - b. A recording of spiritual Christmas music (optional).
 - c. Pencils and crayons.
 - d. Picture 2-7, The Wise Men (Gospel Art Picture Kit 203; 62120).
 8. Make the necessary preparations for any enrichment activities you want to use.
-

Suggested

Lesson

Development

Invite a child to give the opening prayer.

Follow up with the children if you encouraged them to do something during the week.

The Birth of Jesus Christ Was a Great Gift

Attention activity

Show the children the wrapped gift. Tell them there is something inside the package that represents a wonderful gift from someone who loves us very much. Let each child have a turn to hold the package and guess what is inside.

Tell the children the tag is a clue. Read aloud John 3:16. Ask the children if they know now what the gift is and who it is from (you may need to remind the children that *God* is another name for Heavenly Father). Have a child unwrap the gift and hold up the picture so everyone can see it.

Discussion

- What is the gift?
- Who is the gift from?
- Why is the birth of Jesus Christ such a wonderful gift?

Help the children understand that one reason the birth of Christ is such a great gift is that Jesus Christ came to teach us the right way to live. He taught us that loving and helping others will make us happy. By sending Jesus to earth, Heavenly Father gave us a gift that will help us find happiness not just at Christmastime but always.

Song

Sing or say the words to “He Sent His Son” with the children.

The Wise Men Gave Gifts to Baby Jesus

Scripture story
and discussion

Point out that Heavenly Father wanted everyone to know about his gift to us, so he placed a beautiful new star in the sky.

Display picture 2-7, The Wise Men, and ask the children to tell the story of the Wise Men following the star to find Jesus (see Matthew 2:1–12). Help the children with any details they may have forgotten.

Read aloud Matthew 2:11.

- What gifts did the Wise Men bring to Jesus?

Explain that frankincense and myrrh were sweet-smelling perfumes used in religious ceremonies. All three gifts were valuable and difficult to get. The Wise Men wanted to bring Jesus the nicest gifts they could find.

- Why did the Wise Men bring these gifts to Jesus? (To show they loved and honored him.)
- Why did the Wise Men bow down and worship Jesus when they saw him? (They knew he was the Savior, the Son of Heavenly Father.)

Role-playing
activity

Have the children act out the story of the Wise Men. Give a part to every child who wants to participate. Children can be Mary, Joseph, and the Wise Men (have as many Wise Men as you need so that everyone can participate). You may also ask a child to hold the paper star. Help the children put on their costumes or name tags.

To add to the presentation, you may wish to play a recording of spiritual Christmas music softly in the background.

Narrate by reading selected verses from Matthew 2:1–12, particularly verses 2 and 9–11. You may want to have the Wise Men repeat Matthew 2:2 with you. (If necessary, explain that *King of the Jews* is another name for Jesus Christ.)

Giving Gifts of Love Brings Us Joy

Story

Explain that just as the Wise Men brought gifts to Jesus to show their love for him, we can give gifts to others to show our love for them.

Tell the following story about a young boy named S. Dilworth Young, who later became a General Authority:

The Christmas that S. Dilworth Young was five years old, he saw a jigsaw puzzle displayed in the window of a store. The puzzle had a picture of an

old horse-drawn fire truck on it. Dilworth wanted that puzzle for Christmas more than he wanted anything else.

Elder Young later explained what happened with the puzzle on Christmas Day:

“When Christmas morning finally came, I found hung on my chair a stocking full of good things. But right off I spotted my puzzle. It was wrapped in bright paper, but I could tell by the shape what it was. I quickly opened the box and was soon lost in the pleasure of putting the puzzle together.

“Before long my father came into the room and explained to my younger brother, older sister, and me that the Jensen family down the street had recently come from Denmark. He said the father had no job and no money, and then he suggested that we take our Christmas dinner to them. He also asked each of us to select our most loved toy and give it to a child in the Jensen family. . . .

“Before we left for the Jensen’s, I spent three happy hours playing with and enjoying my puzzle. I thought about giving something else, but I knew deep down that there was only one gift to give.

“At eleven forty-five we all started out. Father carried the turkey on a platter. Mother and my sister Emily followed with potatoes, gravy, dressing, cranberries, and dessert. And under my arm, carefully rewrapped, was my fire engine puzzle.

“When we entered the Jensen home, Father placed the turkey on the small bare table in the corner, and the others followed.

“Each one of us in turn then gave his present. Emily gave her beautiful doll to the girl. I stepped forward and looked at the boy about my age. ‘Here,’ I said as I pushed the puzzle at him. He took it from me and smiled. Next my brother gave his offering to the smallest child. And then we returned home.

“It was strange, but somehow as I walked the block between our house and the Jensen’s, it seemed as if my feet didn’t touch the ground. I felt as though I were floating on clouds of good feeling, for I knew I had made someone else happy.

“Even our Christmas dinner of canned beans, bread, butter, and bottled fruit had a special and unforgettable meaning on that special Christmas Day!” (S. Dilworth Young, “Friend to Friend: A Special Christmas,” *Friend*, Dec. 1972, pp. 20–21).

Discussion

- What did Dilworth do that made him happy?
- Why was he happy after giving away his favorite toy?
- Have you ever given something to someone else that made him or her happy?

Let the children talk about times when they have made others happy by giving them gifts.

Teacher presentation

Explain that when we give gifts to others, we show that we love them. While it can make us happy to receive a gift, it can also make us happy to give gifts. Point out that gifts do not have to be expensive to show a lot of love. Some of the best gifts are gifts of service.

Story

Tell a story about a child who gave gifts of service. You may want to use the following story:

Christmas was coming soon, and Beth wanted to give Christmas gifts to her family to show them how much she loved them. But Beth didn't have any money. She thought she wouldn't be able to give any gifts, and she felt very sad. Then Beth remembered that her Primary teacher had told the class that some of the best gifts are gifts that money can't buy. Beth decided to give gifts of service.

Beth made a card for every member of her family, and on each card she wrote something that she would do for that family member. On her younger sister's card, she wrote that she would play a game that her sister liked. On her older brother's card, she wrote that she would wash the dishes one night when it was his turn. For her mother she promised to watch the baby while Mother took a nap, and for her father she promised to help work in the garden. Her favorite gift was for her grandfather: she promised to give him a big hug first thing every morning for a month.

On Christmas morning Beth gave her gifts to her family. Everyone liked Beth's gifts of service. They knew Beth loved them because she gave them such wonderful gifts.

Card activity

Give each child a card and a pencil or some crayons. Tell the children that with these cards each of them can give a gift of service, just as Beth did.

Discuss some gifts that the children can give, such as making a brother or sister's bed, setting the table for dinner, playing with a baby brother or sister, or running an errand for their parents. Help each child choose a gift of service and a person to give the gift to.

Help each child write *I will* at the top of the inside page of the card and *for you* at the bottom of the page.

In the middle of the page have each child draw a picture of what he or she will do for someone else as a gift of service.

If you brought envelopes, give each child an envelope to put the card in. Help the child write the name of the recipient on the envelope or on the front of the card.

Remind the children to give their cards when their families exchange gifts. You may want to suggest that they make similar gifts at home for other family members or friends.

Summary

Teacher presentation

Remind the children that Jesus Christ is the most important gift Heavenly Father has given us. This is because Jesus will help us return to live with him and Heavenly Father someday. Explain that just as Heavenly Father showed his love for us by sending Jesus to the earth, we can show our love for others by giving them special gifts.

Testimony

Bear your testimony that Jesus Christ is our Savior. Tell the children how you feel when you think about how much Heavenly Father and Jesus Christ love each of us. Also tell the children how you feel when you give gifts to others.

Encourage the children to remember Heavenly Father and Jesus Christ as they celebrate Christmas.

Invite a child to give the closing prayer.

Enrichment Activities

Choose from the following activities those that will work best for the children in your class. You can use them in the lesson itself or as a review or summary. For additional guidance, see “Class Time” in “Helps for the Teacher.”

1. Sing or say the words to the first verse of “Silent Night” (*Hymns*, no. 204) with the children.

Silent night! Holy night!
 All is calm, all is bright
 Round yon virgin mother and Child.
 Holy Infant, so tender and mild,
 Sleep in heavenly peace;
 Sleep in heavenly peace.

2. Sing or say the words to “Away in a Manger” (*Children’s Songbook*, p. 42), “Mary’s Lullaby” (*Children’s Songbook*, p. 44), or “Oh, Hush Thee, My Baby” (*Children’s Songbook*, p. 48). The words to these songs are included at the back of the manual.
3. Read Matthew 2:1–2, 9–11 aloud. Discuss the importance of the star to the Wise Men. Help each child cut two triangles out of paper and glue them together to form a star decoration (see pattern below). Let the children take their stars home.

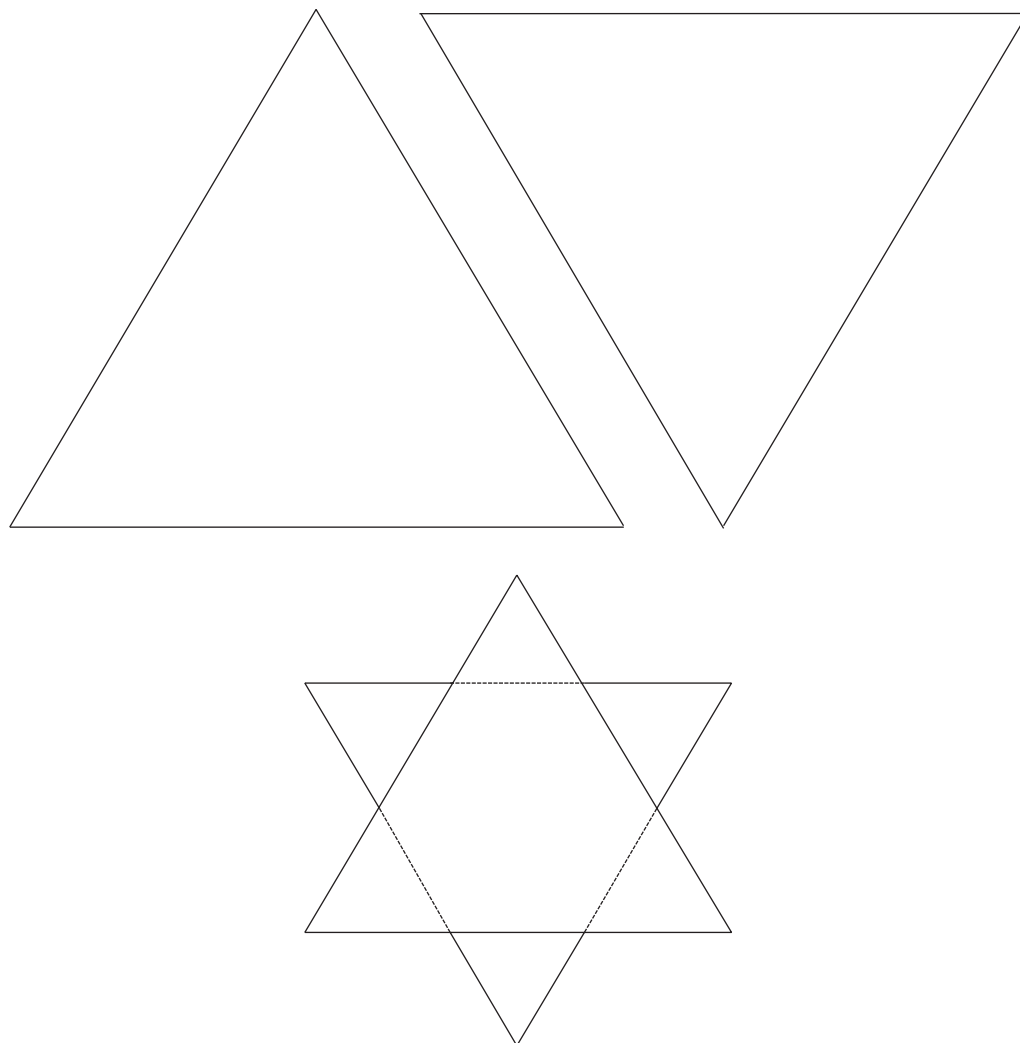

Words to the Songs

A Happy Family

I love mother; she loves me.
We love daddy, yes sirree;
He loves us, and so you see,
We are a happy family.

I love sister; she loves me.
We love brother, yes sirree;
He loves us, and so you see,
We are a happy family.

(© 1948, 1975 by Pioneer Music Press, Inc.
Used by permission of Jackman Music Corp.)

Away in a Manger

Away in a manger, no crib for his bed,
The little Lord Jesus laid down his sweet head;
The stars in the heavens looked down where
 he lay,
The little Lord Jesus, asleep on the hay.

The cattle are lowing, the poor baby wakes;
But little Lord Jesus, no crying he makes.
I love thee, Lord Jesus; look down from the sky
And stay by my cradle till morning is nigh.

Be near me, Lord Jesus; I ask thee to stay
Close by me forever, and love me, I pray.
Bless all the dear children in thy tender care,
And fit us for heaven to live with thee there.

Baptism

Jesus came to John the Baptist,
In Judea long ago,
And was baptized by immersion
In the River Jordan's flow.

"To fulfill the law," said Jesus,
When the Baptist questioned why,
"And to enter with my Father
In the kingdom up on high."

Now we know that we must also
Witness faith in Jesus' word,
Be baptized to show obedience,
As was Jesus Christ, our Lord.

Choose the Right Way

There's a right way to live and be happy;
It is choosing the right ev'ry day.
I am learning the teachings of Jesus;
They will help me and show me the way.

Chorus:

Choose the right way and be happy.
I must always choose the right.

Through the gospel I learn to be prayerful,
To have faith, to repent, to obey,
And I know if I live by his teachings,
I will truly be happy each day.

Chorus

Dare to Do Right

Dare to do right! Dare to be true!
You have a work that no other can do;
Do it so bravely, so kindly, so well,
Angels will hasten the story to tell.
Dare, dare, dare to do right;
Dare, dare, dare to be true,
Dare to be true, dare to be true.

Do As I'm Doing

Do as I'm doing;
Follow, follow me!
Do as I'm doing;
Follow, follow me!
If I do it high or low,
If I do it fast or slow,
Do as I'm doing;
Follow, follow me!
Do as I'm doing;
Follow, follow me!

(© 1963 by D. C. Heath and Company.
Used by permission.)

“Give,” Said the Little Stream

“Give,” said the little stream,
“Give, oh! give, give, oh! give.”
“Give,” said the little stream,
As it hurried down the hill;
“I’m small, I know, but wherever I go
The fields grow greener still.”

Chorus:

Singing, singing all the day,
“Give away, oh! give away.”
Singing, singing all the day,
“Give, oh! give away.”

“Give,” said the little rain,
“Give, oh! give, give, oh! give.”
“Give,” said the little rain,
As it fell upon the flow’rs;
“I’ll raise their drooping heads again,”
As it fell upon the flow’rs.

Chorus

Give, then, as Jesus gives,
Give, oh! give, give, oh! give.
Give, then, as Jesus gives;
There is something all can give.
Do as the streams and blossoms do:
For God and others live.

Chorus

He Sent His Son

How could the Father tell the world of love
and tenderness?
He sent his Son, a newborn babe, with peace
and holiness.
How could the Father show the world the
pathway we should go?
He sent his Son to walk with men on earth,
that we may know.
How could the Father tell the world of sacrifice,
of death?
He sent his Son to die for us and rise with
living breath.
What does the Father ask of us? What do the
scriptures say?
Have faith, have hope, live like his Son, help
others on their way.
What does he ask? Live like his Son.

(© 1982 by Mabel Jones Gabbott. Used by
permission.)

I Am a Child of God

I am a child of God,
And he has sent me here,
Has given me an earthly home
With parents kind and dear.

Chorus:

Lead me, guide me, walk beside me,
Help me find the way.
Teach me all that I must do
To live with him someday.

I am a child of God,
And so my needs are great;
Help me to understand his words
Before it grows too late.

Chorus

I am a child of God.
Rich blessings are in store;
If I but learn to do his will,
I’ll live with him once more.

Chorus

I Feel My Savior’s Love

I feel my Savior’s love
In all the world around me.
His Spirit warms my soul
Through everything I see.

Chorus:

He knows I will follow him,
Give all my life to him.
I feel my Savior’s love,
The love he freely gives me.

Fourth verse:

I’ll share my Savior’s love
By serving others freely.
In serving I am blessed.
In giving I receive.

Chorus

(© 1978, 1979 by K. Newell Dayley. All
rights reserved. Used by permission.)

I Know My Father Lives

I know my Father lives and loves me too.
The Spirit whispers this to me and tells me
it is true,
And tells me it is true.

He sent me here to earth, by faith to live
his plan.
The Spirit whispers this to me and tells me
that I can,
And tells me that I can.

I Like My Birthdays

I like my birthdays, ev'ry one;
Each brings a greater joy to me.
But I can't wait until I'm eight,
For then I'll be baptized, you see.

To be baptized as Jesus was
By one who holds the priesthood true
And thus obey God's holy laws
Is just the thing I want to do.

When hands are laid upon my head,
Then I'll receive the Holy Ghost.
And, if I listen carefully,
I'll have the blessing I need most.

I Thank Thee, Dear Father

I thank thee, dear Father in heaven above,
For thy goodness and mercy, thy kindness
and love.
I thank thee for home, friends, and parents
so dear,
And for ev'ry blessing that I enjoy here.

Help me to be good, kind, and gentle today,
And mind what my father and mother shall say.
In the dear name of Jesus, so loving and mild,
I ask thee to bless me and keep me thy child.

I Think When I Read That Sweet Story

I think when I read that sweet story of old,
When Jesus was here among men,
How he called little children like lambs to
his fold;
I should like to have been with him then.

I wish that his hands had been placed on
my head,
That his arms had been thrown around me,
That I might have seen his kind look when
he said,
"Let the little ones come unto me."

I'm Trying to Be like Jesus

I'm trying to be like Jesus;
I'm following in his ways.
I'm trying to love as he did, in all that
I do and say.
At times I am tempted to make a wrong
choice,
But I try to listen as the still small voice
whispers,

Chorus:

"Love one another as Jesus loves you.
Try to show kindness in all that you do.
Be gentle and loving in deed and in
thought,
For these are the things Jesus taught."

I'm trying to love my neighbor;
I'm learning to serve my friends.
I watch for the day of gladness when Jesus
will come again.
I try to remember the lessons he taught.
Then the Holy Spirit enters into my thoughts,
saying:

Chorus

(© 1980 by Janice Kapp Perry. Used by
permission.)

Jesus Loved the Little Children

Jesus loved the little children,
Little ones like me.
He would bless and help them
And take them on his knee.

Many lovely things he taught them,
Things we all should do:
Love and help each other,
Be honest, kind, and true.

Jesus Said Love Everyone

Jesus said love ev'ryone;
Treat them kindly, too.
When your heart is filled with love,
Others will love you.

Jesus Wants Me for a Sunbeam

Jesus wants me for a sunbeam,
To shine for him each day;
In ev'ry way try to please him,
At home, at school, at play.

Chorus:

A sunbeam, a sunbeam,
Jesus wants me for a sunbeam.
A sunbeam, a sunbeam,
I'll be a sunbeam for him.

Jesus wants me to be loving
And kind to all I see,
Showing how pleasant and happy
His little one can be.

Chorus

Love One Another

As I have loved you,
Love one another.
This new commandment:
Love one another.
By this shall men know
Ye are my disciples,
If ye have love
One to another.

(© 1961, renewed 1989 by Luacine C. Fox.
Used by permission.)

Mary's Lullaby

Lullaby, lullaby, my little one.
Lullaby, my child so dear.
Thy precious life has just begun;
Thy mother holds thee near.
While Joseph watches through the night,
A star reflects thy radiant light.
Lullaby, lullaby, my little one.
Lullaby, my child so dear.

Thy gentle head shall wear a crown,
For thy Father is the King.
Thy tender hands, so tiny now,
Have blessings great to bring.
Let all creation join my song,
For peace and love this night are born.
Lullaby, lullaby, my little one.
Lullaby, my child so dear.

Oh, Hush Thee, My Baby

Oh, hush thee, my baby; a story I'll tell,
How little Lord Jesus on earth came to dwell;
How in a far country, 'way over the sea,
Was born a wee baby, my dear one, like thee.

Chorus:

Lullaby baby, lullaby dear.
Sleep, little baby; have nothing to fear.
Lullaby baby, lullaby dear.
Jesus will care for his little one here.

The story was told by the angels so bright,
As round them was shining a heavenly light.
The stars shone out brightly, but one led
the way
And stood o'er the place where the dear
baby lay.

Chorus

The shepherds here found him, as angels
had said,
The poor little stranger, no crib for a bed.
Down low in a manger so quiet he lay,
This little child Jesus, asleep on the hay.

Chorus

Quickly I'll Obey

When my mother calls me,
Quickly I'll obey.
I want to do just what is best
Each and every day.

When my father calls me,
Quickly I'll obey.
I want to do just what is best
Each and every day.

Heav'nly Father loves me,
Blesses me each day.
I want to do just what is best
Each and every day.

Smiles

If you chance to meet a frown,
Do not let it stay.
Quickly turn it upside down
And smile that frown away.

No one likes a frowning face.
Change it for a smile.
Make the world a better place
By smiling all the while.

The Holy Ghost

When Christ was on the earth,
He promised he would send
The Holy Ghost to comfort us,
Our true, eternal friend.
The Holy Spirit whispers
With a still small voice.
He testifies of God and Christ
And makes our hearts rejoice.

And when we are confirmed
By sacred priesthood pow'r,
The Holy Ghost is giv'n to us
To guide us ev'ry hour.
Oh, may I always listen
To that still small voice,
And with his light I'll do what's right
Each time I make a choice.

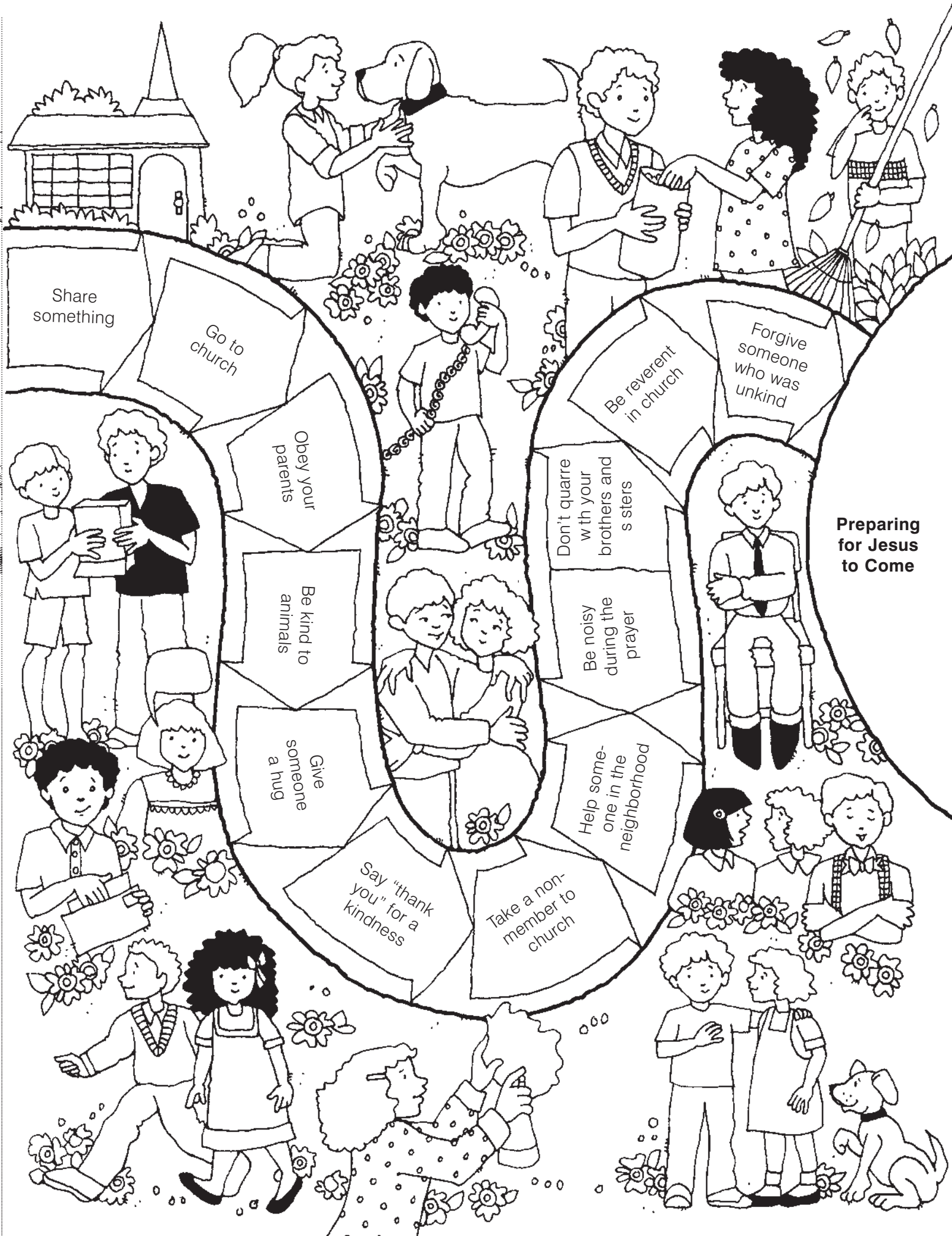

Share something

Go to church

Obey your parents

Be kind to animals

Give someone a hug

Say "thank you" for a kindness

Take a non-member to church

Help someone in the neighborhood

Be noisy during the prayer

Don't quarrel with your brothers and sisters

Be reverent in church

Forgive someone who was unkind

Preparing for Jesus to Come

THE CHURCH OF
JESUS CHRIST
OF LATTER-DAY SAINTS

